

The Boy Electrician

This ebook is for the use of anyone anywhere in the United States and most other parts of the world at no cost and with almost no restrictions whatsoever. You may copy it, give it away or re-use it under the terms of the [Project Gutenberg License](https://www.gutenberg.org/license) included with this ebook or online at <https://www.gutenberg.org/license>. If you are not located in the United States, you'll have to check the laws of the country where you are located before using this ebook.

Title: The Boy Electrician

Author: Alfred Powell Morgan

Release Date: September 15, 2020 [eBook #63207]

Language: English

*** START OF THIS PROJECT GUTENBERG EBOOK THE BOY ELECTRICIAN

Produced by James Simmons.

This file was produced from page images at Google Books.

Transcriber's Note

This book was transcribed from scans of the original found at Google Books. I have rotated some images. The more complex tables are treated as images.

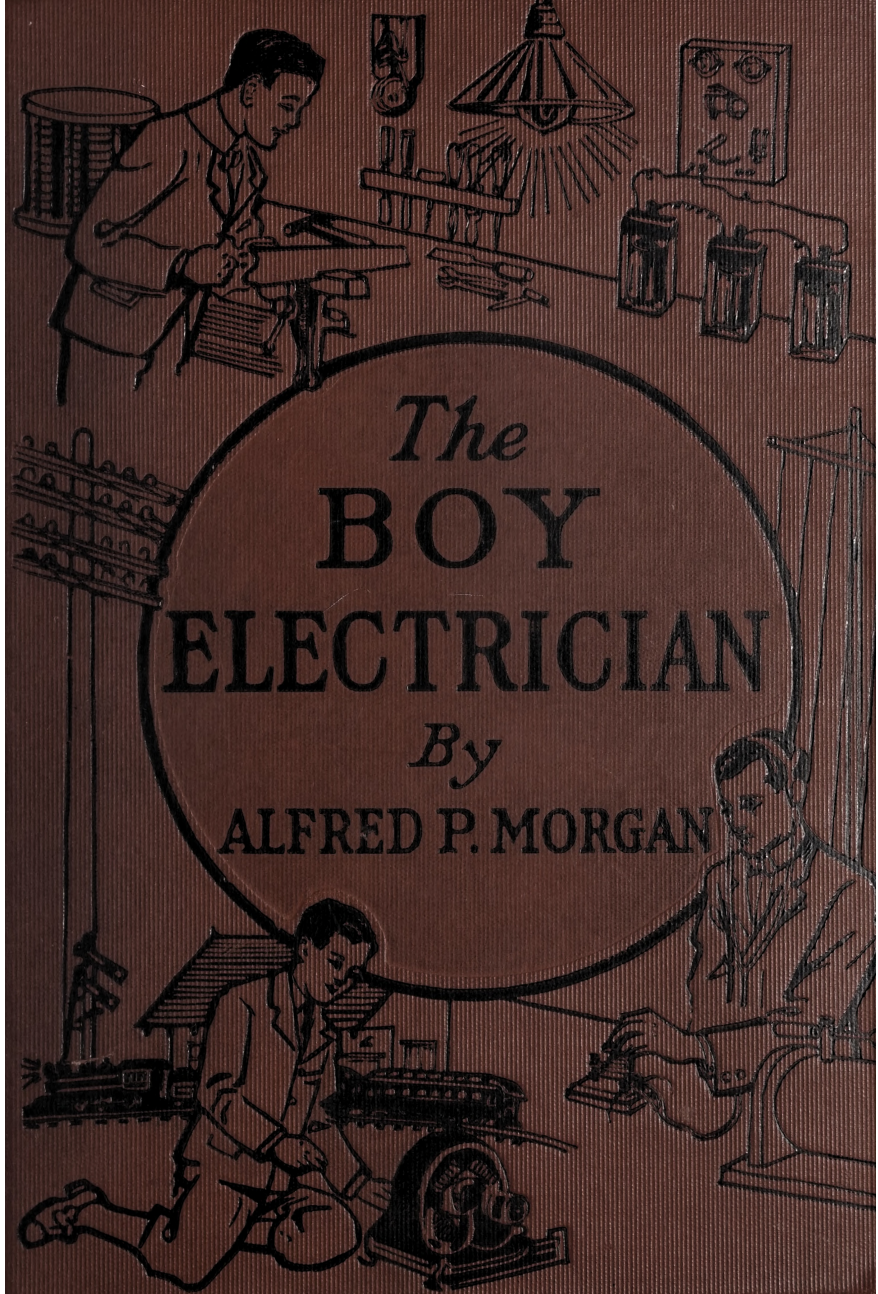

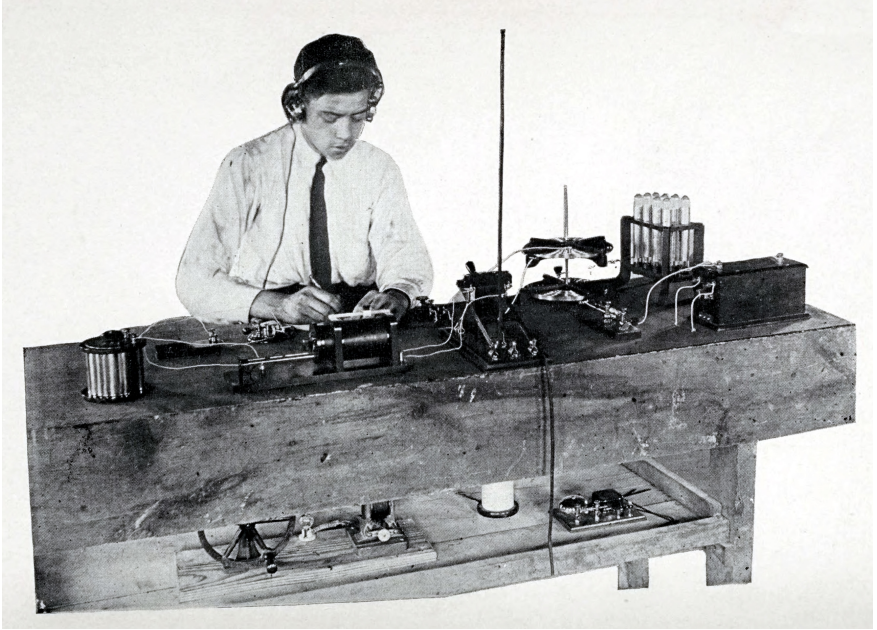

A BOY'S WIRELESS OUTFIT MADE UP OF THE APPARATUS DESCRIBED IN CHAPTER XIV. THE JUNIOR DYNAMO AND A COHERER OUTFIT CAN BE SEEN ON THE LOWER PART OF THE TABLE.



The
BOY
ELECTRICIAN

*Practical Plans for Electrical
Apparatus for work and play, with an explanation
Of the principles of every-day electricity.*

By
ALFRED P. MORGAN
With illustrations by the author

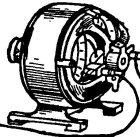

BOSTON
LOTHROP, LEE & SHEPARD CO.

The Boy Electrician

*Practical Plans for Electrical
Apparatus for work and play, with an explanation
Of the principles of every-day electricity.*

By
ALFRED P MORGAN

With illustrations by the author

BOSTON
LOTHROP, LEE & SHEPARD CO.

Copyright, 1913, by Lothrop, Lee & Shepard Co.
Entered at Stationers' Hall, London
Published July, 1914
All rights reserved
THE BOY ELECTRICIAN

NORWOOD PRESS
Berwick & Smith Co.
Norwood, Mass. U.S.A.

TO THE SELF-RELIANT
BOYS OF AMERICA,
OUR FUTURE ENGINEERS AND SCIENTISTS, THAN
WHOM
NONE IN THE WHOLE WORLD ARE BETTER ABLE
TO WORK OUT AND SOLVE THE PROBLEMS
THAT EVER CONFRONT YOUNG
MANHOOD, THIS BOOK
IS CORDIALLY
DEDICATED.

THE BOY ELECTRICIAN

INTRODUCTION

Once upon a time, and this is a true tale, a boy had a whole railroad system for a toy. The train ran automatically, propelled by tiny electric motors, the signals went up and down, the station was reached, a bell rang, the train moved on again and was off on its journey around many feet of track to come back over the old route.

The boy viewed his gift with raptured eyes, and then his face changed and he cried out in the bitterness of his disappointment: "But what do I do?" The toy was so elaborate that the boy was left entirely out of the play. Of course he did not like it. His cry tells a long story.

The prime instinct of almost any boy at play is to *make* and to *create*. He will *make* things of such materials as he has at hand, and use the whole force of dream and fancy to create something out of nothing. The five-year-old will lay half a dozen wooden blocks together with a spool on one end and tell you it is a steam train. And it is. He has both made and created an engine, which he sees but which you don't, for the blocks and spool are only a symbol of his creation. Give his older brother a telephone receiver, some wire and bits of brass, and he will make a wireless telegraph outfit and listen to a steamship hundreds of miles away spell out its message to the shore.

The wireless outfit is not a symbol, but something that you can both hear and see in operation even though you may not understand the whispering of the dots and dashes. And as soon as the mystery of this modern wonder more firmly grips your imagination, you perhaps may come to realize that we are living more and more in the age of electricity and mechanism. Electricity propels our trains, lights our houses and streets, makes our clothes, cures our ills, warms us, cooks for us and performs an innumerable number of other tasks at the turning of a little switch. A mere list is impossible.

Almost every boy experiments at one time or another with electricity and

electrical apparatus. It is my purpose in writing this book to open this wonderland of science and present it in a manner which can be readily understood, and wherein a boy may "do something." Of course there are other books with the same purport, but they do not accomplish their end. They are not practical. I can say this because as a boy I have read and studied them and they have fallen far short of teaching me or my companions the things that we were seeking to learn. If they have failed in this respect, they have done so perhaps not through any inability of the author, but from the fact that they have not been written from the *boy's standpoint*. They tell what the author *thought* a boy ought to know but not what he really does want to know. The apparatus described therein is for the most part imaginary. The author thought it might be possible for a boy to build motors, telegraph instruments, etc., out of old bolts and tin cans, but *he never tried to do so himself*.

The apparatus and experiments that I have described have been constructed and carried out by *boys*. Their problems and their questions have been studied and remedied. I have tried to present practical matter considered wholly from a boy's standpoint, and to show the young experimenter just what he can do with the tools and materials in his possession or not hard to obtain.

To the boy interested in science, a wide field is open. There is no better education for any boy than to begin at the bottom of the ladder and climb the rungs of scientific knowledge, step by step. It equips him with information which may prove of inestimable worth in an opportune moment.

There is an apt illustration in the boy who watched his mother empty a jug of molasses into a bowl and replace the cork. His mother told him not to disturb the jug, as it was empty. He persisted, however, and turned the jug upside down. No more molasses came, but *out crawled a fly*. New developments in science will never cease. Invention will follow invention. The unexpected is often a valuable clue. The Edisons and Teslas of to-day have not discovered everything. *There is a fly in the molasses*, to be had by persistence. Inspiration is but a starting-point. Success means work, days, nights, weeks, and years.

There can be no boy who will follow exactly any directions given to him, or do exactly as he is told, of his own free will. He will "bolt" at the first opportunity. If forced or obliged to do as he is directed, his action will be accompanied by many a "why?" Therefore in presenting the following chapters I have not only told how to *make* the various motors, telegraphs, telephones, radio receivers, etc. but have also explained the principles of electricity upon which they depend for their operation, and how the same thing is accomplished in the every-day world. In giving directions or offering cautions, I have usually stated the reason for so doing, in the hope that this information may be a stimulant to the imagination of the young experimenter and a useful guide in enabling him to proceed along

some of the strange roads on which he will surely go.

ALFRED P. MORGAN

UPPER MONTCLAIR, N. J.

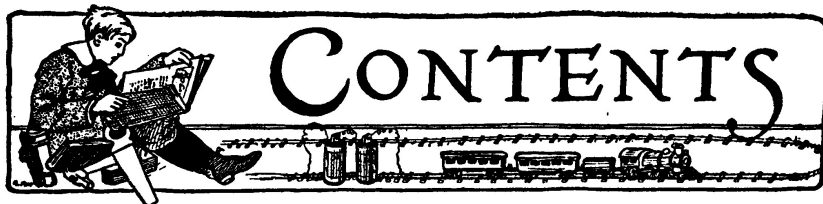

THE BOY ELECTRICIAN

INTRODUCTION

CHAPTER I MAGNETS AND MAGNETISM

CHAPTER II STATIC ELECTRICITY

CHAPTER III STATIC ELECTRIC MACHINES

CHAPTER IV CELLS AND BATTERIES

CHAPTER V ELECTRO-MAGNETISM AND MAGNETIC INDUC-
TION

CHAPTER VI ELECTRICAL UNITS

CHAPTER VII ELECTRICAL APPURTENANCES

CHAPTER VIII ELECTRICAL MEASURING INSTRUMENTS

CHAPTER IX BELLS, ALARMS, AND ANNUNCIATORS

CHAPTER X ELECTRIC TELEGRAPHS

CHAPTER XI MICROPHONES AND TELEPHONES

CHAPTER XII INDUCTION COILS

CHAPTER XIII TRANSFORMERS

CHAPTER XIV WIRELESS TELEGRAPHY

CHAPTER XV A WIRELESS TELEPHONE

CHAPTER XVI ELECTRIC MOTORS

CHAPTER XVII DYNAMOS

CHAPTER XVIII AN ELECTRIC RAILWAY

CHAPTER XIX MINIATURE LIGHTING

CHAPTER XX MISCELLANEOUS ELECTRICAL APPARATUS

- The Full Project Gutenberg License
- Section 1. General Terms of Use & Redistributing Project Gutenberg™
electronic works
- Section 2. Information about the Mission of Project Gutenberg™
- Section 3. Information about the Project Gutenberg Literary Archive
Foundation
- Section 4. Information about Donations to the Project Gutenberg Lit-
erary Archive Foundation
- Section 5. General Information About Project Gutenberg™ electronic
works.

A BOY'S WIRELESS OUTFIT MADE UP OF THE APPARATUS DESCRIBED IN CHAPTER XIV. THE JUNIOR DYNAMO AND A COHERER OUTFIT CAN BE SEEN ON THE LOWER PART OF THE TABLE.

Fig. 1.—The Card of a Mariner's Compass, Showing the "Points."

Fig. 2.—A Bar Magnet

Fig. 3.—A Horseshoe Magnet

Fig. 4.—A Magnetized Needle and a Bar Magnet which have been dipped in Iron Filings.

Fig. 5.—The Lifting Power of a Bar Magnet. *It must be brought closer to the nails than the tacks because they are heavier.*

Fig. 6.—A Simple Compass.

Fig. 7.—Several Different Methods of Making a Simple Compass.

Fig. 8.—The Attraction of an Iron Nail through *Glass*.

Fig. 9.—A Magnetic Chain.

Fig. 10.—An Experiment Illustrating that Like Poles Repel Each Other and Unlike Poles Attract.

Fig. 11.—A Magnetic Boat.

Fig. 12.—Repulsion between Similar Poles, Shown by Floating Needles.

Fig. 13.—A Magnetic "Phantom," Showing the Field of Force about a Magnet.

Fig. 14.—Magnetic Phantom showing the Lines of Force about a Horseshoe Magnet.

Fig. 15.—Lines of Force between Like and Unlike Poles.

Fig. 16.—A Simple Dipping Needle.

Fig. 17.—An Electrified Glass Rod will Attract Small Bits of Paper.

From the author's "Wireless Telegraphy and Telephony" by permission. A Double Lightning Discharge from a Cloud to the Earth.

Fig. 19.—A Piece of Dry Writing-Paper may be Electrified by Rubbing.

Fig. 20.—A Surprise for the Cat.

Fig. 21.—A Paper Electroscope.

Fig. 22.—A Pith-Ball Electroscope.

Fig. 23.—A Double Pith-Ball Electroscope.

Fig. 24.—A Gold-Leaf Electroscope.

Fig. 25.—Method of Suspending an Electrified Rod in a Wire Stirrup.

Fig. 26.—Similarly Electrified Bodies Repel Each Other. Dissimilarly Electrified Ones Attract Each Other.

Fig. 27.—The Electrophorous

Fig. 28.—An Electric Frog-Pond.

Fig. 29.—Front View of a Cylinder Electric Machine.

Fig. 30.—Method of Finding the Center of a Circle.

Fig. 31.—The "Rubber."

Fig. 32.—The Prime Conductor or Collector.

Fig. 33.—The Complete Cylinder Electric Machine.

Fig. 34.—Paper Pattern for laying out the Plates.

Fig. 35.—Plate with Sectors in Position, and a Pattern for the Sectors.

Fig. 36.—A Side View of one of the Bosses, showing the Brass Bushing used.

Fig. 37.—The Frame.

Fig. 38.—The Upright.

Fig. 39.—The Driving-Wheels and Axle.

Fig. 40.—The Boss and Axle. For sake of clearness, the Plate is not shown.

Fig. 41.—Showing how the Ball, Comb, etc., are mounted on the Glass Rod.

Fig. 42.—A Comb or Collector.

Fig. 43.—Showing how the Tinsel Brushes are arranged on the "Neutralizer" Rods.

Fig. 44.—The Complete Wimshurst Electric Machine. B B B B, *Brushes*. C C, *Combs*. D B, *Discharge Ball*. I I, *Glass Rods*. H, *Handle*. Q Q, *Quadrant Rods*. S S S S S, *Sectors*. S G, *Spark-Gap*. P P, *Driving-Wheels*. For the sake of clearness, several of the sectors are not shown.

Fig. 45.—The Leyden Jar.

Fig. 46.—A Wooden Mortar for Igniting Gunpowder.

Fig. 47.—An Electric Umbrella.

Fig. 48.—A Lightning Board.

Fig. 49.—An Electric Dance.

Fig. 50.—An Electric Whirl.

Fig. 51.—Lichtenberg's Figures.

Fig. 52.—The Voltaic Cell.

Fig. 53.—The Elements of Simple Voltaic Cell.

Fig. 54.—A Home-Made Voltaic Cell.

Fig. 55.—Carbon-Cylinder Cell, and Cylinder.

Fig. 56.—A Leclanche Cell, showing the Porous Cup.

Fig. 57.—A Dry Cell.

Fig. 58.—The Different Operations involved in Making a Dry Cell.

Fig. 59.—A Zinc-Carbon Element, made from Heavy plates.

Fig. 60.—A Method of making a Cell Element from Carbon Rods.

Fig. 61. An Element made from two Carbon Plates and a Zinc Rod.

Fig. 62. A Method of Mounting four Carbon Plates.

Fig. 63.—A Battery Element arranged for three Cells.

Fig. 64.—A Plunge Battery, with Windlass.

Fig. 65.—A Plunge Battery adapted to a Set of Elements, as shown in Figure 63. They may be lifted out and placed on the "Arms" to drain.

Fig. 66.—An Edison-Lalande Cell.

Fig. 67.—A Tomato-Can Cell; Sectional View.

Fig. 68.—The Tomato-Can Cell Complete.

Fig. 69.—Two Methods of Connecting Cells so as to obtain Different Voltage and Amperage Values.

Fig. 70.—Small Storage Cells.

Fig. 71.—How to make the Plates for a Storage Cell.

Fig. 72.—The Wood Separator.

Fig. 73.—The Complete Element for a Storage Cell.

Fig. 74.—A Battery of Home-Made Storage Cells.

Fig. 75.—Gravity Cells. These consist of zinc and copper elements, immersed in a zinc-copper sulphate solution. They cannot be easily made, and are best purchased. The illustration also shows the star-shaped copper and "crowfoot" zinc element used in a gravity cell.

Fig. 76.—A Current of Electricity flowing through a Wire will deflect a Compass Needle.

Fig. 77.—If a Loop of Wire is formed about a Compass Needle, the Deflection will be greater.

Fig. 78.—Iron Filings clustered on a Wire carrying a Current of Electricity.

Fig. 79.—Magnetic Phantom formed about a Wire carrying a Current of Electricity.

Fig. 80.—Magnetic Phantom formed about several Turns of wire.

Fig. 81.—Paper Tube wrapped with Wire for Experimental Purposes.

Fig. 82.—Showing how the Lines of Force "Leak" at the sides of the coil, from a Coil of Wire, and how they are concentrated by an Iron Core.

Fig. 83.—The Principle of an Electro-Magnet.

Fig. 84.—if you wrap some insulated Wire around an Ordinary Nail and connect it to a Battery, it will become an Electro-Magnet.

Fig. 85.—If you wind the Wire around a small Paper Tube into which a Nail will slide easily, the Coil will draw the Nail in when the Current is turned on.

By permission, from "Solenoids" by C. R. Underhill. Lifting-Magnets of the type known as Plate, Billet, and Ingot Magnets.

Fig. 86.—Showing how a Current of Electricity may be induced by a Bar Magnet and a Coil.

Fig. 87.—A Horseshoe Magnet and a Coil arranged to produce Electric Currents by *Induction*.

Fig. 88.—Graphic Representation of a Direct and an Alternating Current.

Fig. 89.—Staples and Wooden Cleat used for running Low Voltage Wires.

Fig. 90.—Porcelain Insulators to support Electric Light Wires.

Fig. 91.—Glass Insulator Binding-Posts and Pin used to support Telegraph and Telephone wires.

Fig. 92.—Types of Binding-Posts.

Fig. 93.—Home-made Binding-Posts.

Fig. 94.—Binding-Post removed from the Carbon of a Dry Cell.

Fig. 95.—Simple Switches. *A*, Single-Point Switch. *B*, Two-Point Switch. *C*, Three-Point Switch. *D*, Five-Point Switch. *E*, Lever with End Rolled up to form Handle. *F*, Lever with Handle made from part of a Spool.

Fig. 96.—Knife Switches.

Fig. 97.—Metal Parts for the Knife Switches.

Fig. 98.—Simple Fuses. *A*, Fuse-Block with plain Wire Fuse. *D*, Fuse-Block with Mica Fuse in position.

Fig. 99.—Lightning-Arrester and Ground-Wire Switch.

- Fig. 100.—Home-made Lightning-Arrester.
- Fig. 101.—Lightning-Arrester for Telephone Wires.
- Fig. 102.—*A*, Base, showing Slot. *B* and *C*, Sides and Top of the Bobbin. *D*, Base and Bobbin in Position.
- Fig. 103.—Arrangement of the Needle and Pointer.
- Fig. 104.—*A*, Bearings. *B*, How the Needle is mounted.
- Fig. 105.—The Completed Meter.
- Fig. 106.—Details of the Bobbin.
- Fig. 107.—The Bobbin partly cut away so as to show the Bearing. Details of the Armature and Shaft.
- Fig. 108.—Completed Voltmeter.
- Fig. 109.—Circuits for Calibrating the Ammeter and Voltmeter.
- Fig. 110.—Simple Compass Galvanoscope.
- Fig. 111.—Galvanoscope.
- Fig. 112.—Astatic Galvanoscope.
- Fig. 113.—Astatic Needles.
- Fig. 114.—Bobbin for Astatic Galvanometer.
- Fig. 115.—Completed Astatic Galvanometer.
- Fig. 116.—Wheatstone Bridge.
- Fig. 117.—Knife-Contact.
- Fig. 118.—Resistance-Coil. *A* shows how the Wire is doubled and wound on the Spool. *B* is the completed Coil.
- Fig. 119.—Details of the Magnet Spools, and Yoke for an Electric Bell.
- Fig. 120.—Details of the Armature, and Contact Screw.
- Fig. 121.—The Completed Bell.

Fig. 122.—Diagram showing how to connect a Bell, Battery, and Push-Button.

Fig. 123.—Two Simple Push-Buttons.

Fig. 124.—Diagram showing how to arrange a Bell System of Return Signals.

Fig. 125.—Burglar-Alarm Trap.

Fig. 126.—An Early-Riser's Electric Alarm Attachment for a Clock.

Fig. 127.—Details of the Chain Electrodes, etc.

Fig. 128.—An Annunciator Drop.

Fig. 129.—Details of the Drop-Frame and Armature.

Fig. 130.—A Typical Telegraph Key, showing the Various Parts.

Fig. 131.—A Typical Telegraph Sounder, showing the Various Parts.

Fig. 132.—A Simple Home-made Telegraph Key.

Fig. 133.—A Simple Home-made Telegraph Sounder.

Fig. 134.—A Diagram showing how to connect two Simple Telegraph Stations.

Fig. 135.—A Complete Telegraph Set, consisting of a Keyboard and a Sounder.

Fig. 136.—Details of the Telegraph Set shown in Figure 135.

Fig. 137.—A Diagram showing how to connect two Complete Telegraph Sets, using one Line Wire and a Ground. The Two-Point Switches throw the Batteries out of Circuit when the Line is not in use.

Fig. 138.—Details of the Relay Parts.

Fig. 139.—The Completed Relay.

Fig. 140.—A Diagram showing how to connect a Relay, Sounder, and Key. Closing the Key will operate the Relay. The Relay will then operate the Sounder in turn.

Fig. 141.—How to hold a Telegraph Key.

Fig. 142.—The Morse Telegraphic Code.

Fig. 143.—A Microphone connected to a Telephone Receiver, and a Battery.

Fig. 144.—A Very Sensitive Form of Microphone, with which the Footsteps of a Fly can be heard.

Fig. 145.—A Telephone System, consisting of a Receiver, Transmitter, and a Battery connected in Series. Words spoken into the Transmitter are reproduced by the Receiver.

Fig. 146.—A Watch-Case Telephone Receiver.

Fig. 147.—A Simple Form of Telephone Receiver.

Fig. 148.—A Home-made Telephone Transmitter.

Fig. 149.—A Complete Telephone Instrument. Two Instruments such as this are necessary to form a simple Telephone System.

Fig. 150.—Diagram of Connection for the Telephone Instrument shown in Fig. 149.

Fig. 151.—A Desk-Stand Type of Telephone.

Fig. 152.—A Telephone Induction Coil.

Fig. 153.—Diagram of Connection for a Telephone System employing an Induction Coil at each Station.

Fig. 154.—Details of Various Parts of a Medical Coil.

Fig. 155.—Details of Interrupter for Medical Coil.

Fig. 156.—Completed Medical Coil.

Fig. 157.—Diagram showing Essential Parts of Induction Coil.

Fig. 158.—Empty Paper Tube, and Tube filled with Core Wire preparatory to winding on the Primary.

Fig. 159.—Illustrating the Various Steps in winding on the Primary and fastening the Ends of the Wire.

Fig. 160.—Complete Primary Winding and Core.

Fig. 161.—The Primary covered with Insulating Layer of Paper ready for the Secondary.

Fig. 162.—Simple Winding Device for winding the Secondary.

Fig. 163.—Completed Secondary Winding.

Fig. 164.—Interrupter Parts.

Fig. 165.—Condenser.

Fig. 166.—Completed Coil.

Fig. 167.—Diagram showing how to connect the Apparatus for the "Electric Hands" Experiment.

Fig. 168.—Geissler Tubes.

Fig. 169.—The Bulb will emit a Peculiar Greenish Light.

Fig. 170.—An Electrified Garbage-can.

Fig. 171.—Jacob's Ladder.

Fig. 172.—An X-Ray Tube.

Fig. 173.—Fluoroscope.

Fig. 174.—How to connect an X-Ray Tube to a Spark-Coil.

An X-Ray Photograph of the hand taken with the Outfit shown in Figure 174. The arrows point to injuries to the bone of the third finger near the middle Joint Resulting in a Stiff Joint.

Fig. 175.—Comparison between Electric Current and Flow of Water.

Fig. 176.—Alternating Current System for Light and Power.

Fig. 177.—Motor Generator Set for changing Alternating Current to Direct Current.

Fig. 178.—Step-Up Transformer.

Fig. 179.—Step-Down Transformer.

Fig. 180.—Core Dimensions.

Fig. 181.—The Core, Assembled and Taped.

Fig. 182.—Transformer Leg.

Fig. 183.—Fiber Head.

Fig. 184.—Leg with Heads in Position for Winding.

Fig. 185.—How to make a Tap in the Primary by soldering a Copper Strip to the Wire.

Fig. 186.—The Transformer completely Wound and ready for Assembling.

Fig. 187.—Wooden Strips for mounting the Transformer on the Base.

Fig. 188.—Details of the Switch Parts.

Fig. 189.—The Complete Switch.

Fig. 190.—Diagram of Connections.

Fig. 191.—Top View of the Transformer.

Fig. 192.—Side View of the Transformer.

Fig. 193.—Little Waves spread out from the Spot.

Fig. 194.—A Simple Transmitter.

Fig. 195.—A Simple Receptor.

Fig. 196.—Molded Aerial Insulator

Fig. 197.—A Porcelain Cleat will make a Good Insulator for Small Aerials.

Fig. 198.—Method of Arranging the Wires and Insulating them from the Cross Arm or Spreader.

Fig. 199.—Various Types of Aerials.

Fig. 200.—A Ground Clamp for Pipes.

Fig. 201.—Details of the Tuning Coil.

Fig. 202.—Side and End Views of the Tuning Coil.

Fig. 203.—Complete Double-Slider Tuning Coil.

Fig. 204.—A Simple Loose Coupler.

Fig. 205.—Details of the Wooden Parts.

Fig. 206.—Side View of the Loose Coupler.

Fig. 207.—Top View of the Loose Coupler.

Fig. 208.—End Views of the Loose Coupler.

Fig. 209.—Complete Loose Coupler.

Fig. 210.—A Crystal Detector.

Fig. 211.—Details of the Crystal Detector.

A Double Slider Tuning Coil.

A Junior Loose Coupler.

Crystal Detectors.

Fig. 212 Details of the "Cat Whisker" Detector.

Fig. 213.—Another Form of the "Cat-Whisker" Detector.

Fig. 214.—"Cat-Whisker" Detector.

Fig. 215.—Building up a Fixed Condenser.

Fig. 216.—A Fixed Condenser enclosed in a Brass Case made from a Piece of Tubing fitted with Wooden Ends.

Fig. 217.—A Telephone Head Set.

Fig. 218.—A Circuit showing how to connect a Double-Slider Tuning Coil.

Fig. 219.—Circuit showing how to connect a Loose Coupler.

Fig. 220.—A Diagram showing how to connect some of the Instruments described in this Chapter.

Fig. 221.—A Wireless Spark Coil.

Fig. 222.—Small Spark Gaps.

Fig. 223.—Diagram showing how to connect a Simple Transmitter.

Fig. 224.—A Test-Tube Leyden Jar.

Fig. 225.—Eight Test-Tube Leyden Jars mounted in a Wooden Rack.

Fig. 226.—A Helix and Clip.

Fig. 227.—An Oscillation Transformer.

AN OSCILLATION HELIX.

AN OSCILLATION CONDENSER.

Fig 228.—Circuit showing how to connect a Helix and a Condenser.

Fig 229.—Circuit showing how to connect an Oscillation Transformer and a Condenser.

Fig 230.—An Aerial Switch.

Fig 231.—A Complete Wiring Diagram for both the Transmitter and the Receptor.

Fig. 232.—The Continental Alphabet.

Fig. 233.—A Coherer and a Decoherer.

Fig. 234.—Details of the Coherer.

Fig. 235.—The Relay.

Fig. 236.—The Complete Coherer Outfit.

Fig. 237.—A Simple Arrangement showing the Inductive Action between two Coils.

Fig. 238.—A Simple Wireless Telephone. Speech directed into the Transmitter can be heard in the Receiver, although there is no direct electrical connection between the two.

Fig. 239.—A Double-Contact Strap-Key. The Dotted Lines show how the Binding-Posts are connected.

Fig. 240.—The Circuit of the Wireless Telephone. When the Key is up, the Receiver is ready for Action. When the Key is pressed, the Transmitter and Battery are thrown into the Circuit.

Fig. 241.—A Complete Wireless Telephone and Telegraph Station for Amateurs. 1. The Telephone Coil. 2. The Telephone Transmitter. 3. Double-Contact Strap-Key. 4. The Battery. 5. Spark Coil. 6. Key. 7. Spark-Gap. 8. Aerial Switch. 9. Loose Coupler. 10. Detector, 11. Fixed Condenser. 12. Code Chart. 13. Amateur License. 14. Aerial. 15. Telephone Receivers.

Fig. 242.—A Simple Electric Motor which may be made in Fifteen Minutes.

Fig. 243.—Details of the Armature of the Simplex Motor.

Fig. 244.—The Armature.

Fig. 245.—The Field.

Fig. 246.—The Field and Commutator.

Fig. 247.—The Bearings.

Fig. 248.—The Complete Motor.

Fig. 249.—Details of the Motor.

Fig. 250.—Complete Motor.

Fig. 251—A Telephone Magneto.

Fig. 252.—The Principle of the Alternator and the Direct-Current Dynamo.

Fig. 253.—Details of the Armature, Commutator, and Brushes.

Fig. 254.—The Complete Generator.

Fig. 255.—Details of the Field Casting.

Fig. 256.—Details of the Armature Casting.

Fig. 257.—Details of the Commutator.

Fig. 258.—Diagram showing how to connect the Armature Winding to the Commutator.

Fig. 259.—Details of the Wooden Base.

Fig. 260.—The Pulley and Bearings.

Fig. 261.—The Brushes.

THE JUNIOR DYNAMO MOUNTED ON A LONG WOODEN BASE AND BELTED TO A GROOVED WHEEL FITTED WITH A CRANK SO THAT THE DYNAMO CAN BE RUN AT HIGH SPEED BY HAND POWER. THE ILLUSTRATION ALSO SHOWS A SMALL INCANDESCENT LAMP CONNECTED TO THE DYNAMO SO THAT WHEN THE CRANK IS TURNED THE LAMP WILL LIGHT.

Fig. 262.—Complete Dynamo.

Fig. 263.—Complete Electric Railway operated by Dry Cells. Note how the Wires from the Battery are connected to the Rails by means of the Wooden Conductors illustrated in Figure 277.

Fig. 264.—Details of the Floor of the Car.

Fig. 265.—Details of the Bearing which supports the Wheel and Axle.

Fig. 266.—The Wheels and Axle.

Fig. 267.—The Motor.

Fig. 268.—The Complete Truck of the Car without the Body.

Fig. 269.—Pattern for the Sides and Ends of the Car.

Fig. 270.—The Roof of the Car.

Fig. 271.—The Completed Car.

Fig. 272.—Details of a Wooden Tie.

Fig. 273.—Arrangement of Track.

Fig. 274.—Three Different Patterns for laying out the Track.

Fig. 275.—Details of the Base of the Cross-over.

Fig. 276.—The Completed Cross-over.

Fig. 277.—A Connector for joining the Ends of the Rails.

Fig. 278.—A Bumper for preventing the Car from leaving the Rails.

Fig. 279.—A Design for a Railway Bridge.

Fig. 280.—A Design for a Railway Station.

- Fig. 281.—Miniature Carbon Battery Lamp.
- Fig. 282.—Miniature Tungsten Battery Lamp.
- Fig. 283.—Lamps fitted respectively with Miniature, Candelabra, and Edison Bases.
- Fig. 284.—Miniature Flat-Base Porcelain Receptacle.
- Fig. 285.—Weather-proof and Pin-Sockets.
- Fig. 286.—Types of Battery Switches suitable for Miniature Lighting.
- Fig. 287.—How Lamps are Connected in Multiple.
- Fig. 288.—How Lamps are Connected in Series.
- Fig. 289.—Three-way Wiring Diagram. The Light may be turned off or on from either Switch.
- Fig. 290.—A Lamp Bracket for Miniature Lighting.
- Fig. 291.—A Home-made Bracket.
- Fig. 292.—A Hanging Lamp.
- Fig. 293.—How the Reflector is made.
- Fig. 294.—A Three-Cell Dry Battery for use in Hand-Lanterns, etc.
- Fig. 295.—An Electric Hand-Lantern.
- Fig. 296.—An Electric Ruby Lantern.
- Fig. 297.—The Electric Ruby Lamp with Glass and Shield Removed.
- Fig. 298.—An Electric Night-Light for telling the Time during the Night.
- Fig. 299.—A Watch-Light.
- Fig. 300.—A "Pea" Lamp attached to a Flexible Wire and a Plug.
- Fig. 301.—Four Steps in Carving a Skull Scarf-Pin. 1. The Bone. 2. Hole drilled in Base. 3. Roughed out. 4. Finished.
- Fig. 302.—The Completed Pin ready to be connected to a Battery by removing the Lamp from a Flashlight and screwing the Plug into its Place.

Fig. 303.—How the Copper Wires (*C*) and the Silver Wires (*I*) are twisted together in Pairs.

Fig. 304.—Wooden Ring.

Fig. 305.—Complete Thermopile. An Alcohol Lamp should be lighted and placed so that the Flame heats the Inside Ends of the Wires in the Center of the Wooden Ring.

Fig. 306.—A Reflectoscope.

Fig. 307.—How the Lens is Arranged and Mounted.

Fig. 308.—A View of the Reflectoscope from the Rear, showing the Door, etc.

Fig. 309.—A View of the Reflectoscope with the Cover removed, showing the Arrangement of the Lamps, etc.

Fig. 310.—A Socket for holding the Lamp.

Fig. 311.—The Tin Reflector.

Fig 312.—Top View of Lamp Bank, showing how the Circuit is arranged. A and B are the Posts to which should be connected any Device it's desirable to operate.

Fig. 313.—A Glass Jar arranged to serve as an Electro-Plating Tank.

Fig. 314.—A Rheostat.

Fig. 315.—A Pole-Changing Switch or Current Reverser. The Connecting Strip is pivoted so that the Handle will operate both the Levers, A and B.

COMPLETE RECEIVING SET, CONSISTING OF DOUBLE SLIDER TUNING COIL, DETECTOR AND FIXED CONDENSER.

COMPLETE RECEIVING SET, CONSISTING OF A LOOSE COUPLER IN PLACE OF THE TUNING COIL, DETECTOR AND FIXED CONDENSER.

Fig. 316. A Complete Wireless Receiving Outfit.

Fig. 317.—Illustrating the Principle of the Tesla Coil. A Leyden Jar discharges through the Primary Coil and a High-Frequency Spark is produced at the Secondary.

Fig. 318.—Details of the Wooden Rings used as the Primary Heads.

Fig. 319.—Details of the Cross Bars which support the Primary Winding.

Fig. 320.—The Secondary Head.

A COMPLETE COHERER OUTFIT AS DESCRIBED ON PAGE 274.

THE TESLA HIGH FREQUENCY COIL.

Fig. 321.—End View of the Complete Tesla Coil.

Fig. 322.—The Complete Tesla Coil.

Fig 323.—Showing how a Glass-Plate Condenser is built up of Alternate Sheets of Tinfoil and Glass.

Fig. 324.—A Diagram showing the Proper Method of Connecting a Tesla Coil.

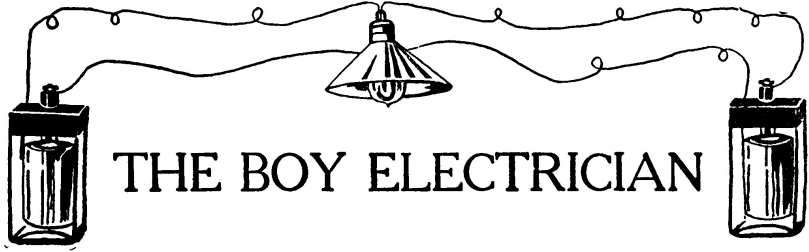

THE BOY ELECTRICIAN

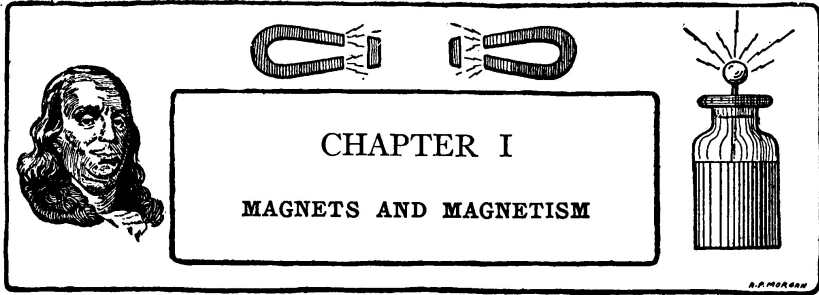

CHAPTER I MAGNETS AND MAGNETISM

Over two thousand years ago, in far-away Asia Minor, a shepherd guarding his flocks on the slope of Mount Ida suddenly found the iron-shod end of his staff adhering to a stone. Upon looking further around about him he found many other pieces of this peculiar hard black mineral, the smaller bits of which tended to cling to the nails and studs in the soles of his sandals.

This mineral, which was an ore of iron, consisting of iron and oxygen, was found in a district known as Magnesia, and in this way soon became widely known as the "Magnetstone," or magnet.

This is the story of the discovery of the magnet. It exists in legends in various forms. As more masses of this magnetic ore were discovered in various parts of the world, the stories of its attractive power became greatly exaggerated, especially during the Middle Ages. In fact, magnetic mountains which would pull the iron nails out of ships, or, later, move the compass needle far astray, did not lose their place among the terrors of the sea until nearly the eighteenth century.

For many hundreds of years the magnet-stone was of little use to mankind save as a curiosity which possessed the power of attracting small pieces of iron and steel and other magnets like itself. Then some one, no one knows who, discovered that if a magnet-stone were hung by a thread in a suitable manner it would always tend to point North and South; and so the "Magnet-stone" became also called the "lodestone," or "leading-stone."

These simple bits of lodestone suspended by a thread were the forerunners of the modern compass and were of great value to the ancient navigators, for they enabled them to steer ships in cloudy weather when the sun was obscured and on nights when the pole-star could not be seen.

The first real *compasses* were called *gnomons*, and consisted of a steel needle

which had been rubbed upon a lodestone until it acquired its magnetic properties. Then it was thrust through a reed or short piece of wood which supported it on the surface of a vessel of water. If the needle was left in this receptacle, naturally it would move against the side and not point a true position. Therefore it was given a circular movement in the water, and as soon as it came to rest, the point on the horizon which the north end designated was carefully noted and the ship's course laid accordingly.

The modern mariners' compass is quite a different arrangement. It consists of three parts, the *bowl*, the *card*, and the *needle*. The bowl, which contains the card and needle, is usually a hemispherical brass receptacle, suspended in a pair of brass rings, called *gimbals*, in such a manner that the bowl will remain horizontal no matter how violently the ship may pitch and roll. The card, which is circular, is divided into 32 equal parts called the *points of the compass*. The needles, of which there are generally from two to four, are fastened to the bottom of the card.

In the center of the card is a conical socket poised on an upright pin fixed in the bottom of the bowl, so that the card hanging on the pin turns freely around its center. On shipboard, the compass is so placed that a black mark, called the *lubber's line*, is fixed in a position parallel to the keel. The point on the compass-card which is directly against this line indicates the direction of the ship's head.

Experiments with Magnetism

The phenomena of magnetism and its laws form a very important branch of the study of electricity, for they play an important part in the construction of almost all electrical apparatus.

Dynamos, motors, telegraphs, telephones, wireless apparatus, voltmeters, ammeters, and so on through a practically endless list, depend upon magnetism for their operation.

Artificial Magnets are those made from steel by the application of a lodestone or some other magnetizing force.

The principal forms are the Bar and Horseshoe, so called from their shape. The process of making such a magnet is called *Magnetization*.

Small horseshoe and bar magnets can be purchased at toy-stores. They can be used to perform very interesting and instructive experiments.

Stroke a large darning-needle from end to end, always in the same direction, with one end of a bar magnet. Then dip the needle in some iron filings and it will be found that the filings will cling to the needle. The needle has become a magnet.

Dip the bar magnet in some iron filings and it will be noticed that the filings

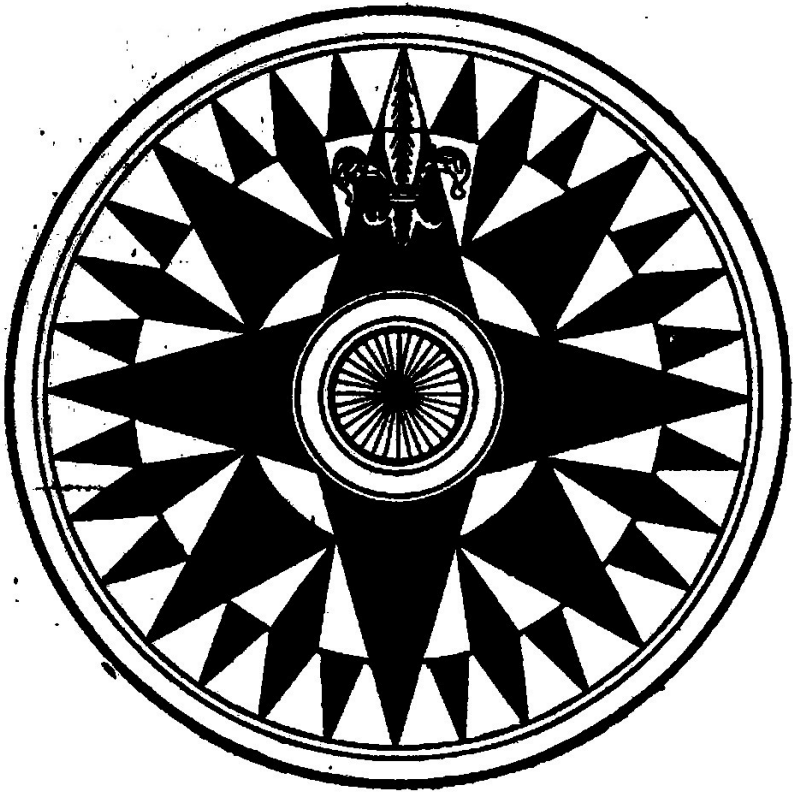

Fig. 1.—The Card of a Mariner's Compass, Showing the "Points."



Fig. 2.—A Bar Magnet

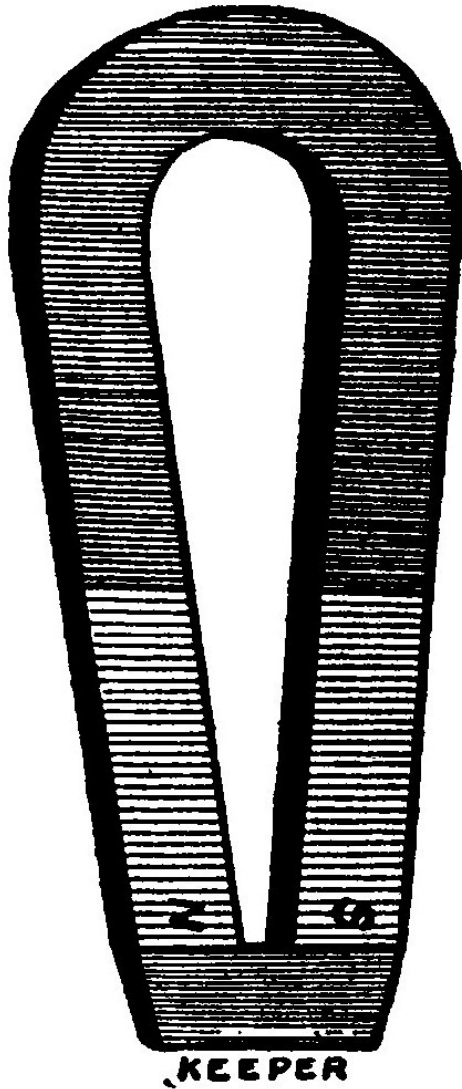

Fig. 3.—A Horseshoe Magnet

cling to the magnet in irregular tufts near the ends, with few if any near the middle.

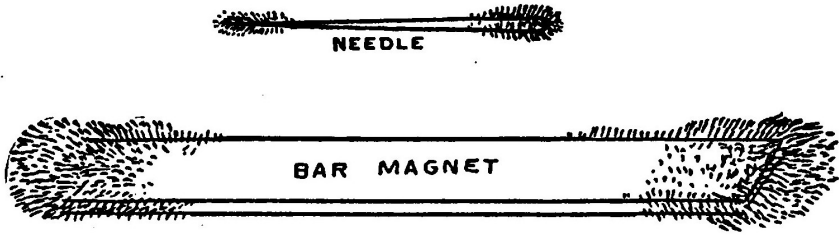

Fig. 4.—A Magnetized Needle and a Bar Magnet which have been dipped in Iron Filings.

This experiment shows that the attractive power of a magnet exists in *two opposite* places. These are called the poles.

There exists between magnets and bits of iron and steel a peculiar unseen force which can exert itself across space.

The power with which a magnet attracts or repels another magnet or attracts bits of iron and steel is called

Magnetic Force. The force exerted by a magnet upon a bit of iron is not the same at all distances. The force is stronger when the magnet is near the iron and weaker when it is farther away.

Place some small carpet-tacks on a piece of paper and hold a magnet above them. Gradually lower the magnet until the tacks jump up to meet it.

Then try some nails in place of the tacks. The nails are heavier than the tacks, and it will require a greater force to lift them. The magnet will have to be brought much closer to the nails than to the tacks before they are lifted, showing that the force exerted by the magnet is strongest nearest to it.

Magnetize a needle and lay it on a piece of cork floating in a glass vessel of water. It will then be seen that the needle always comes to rest lying nearly in a north and south line, with the same end always toward the north.

The pole of the magnet which tends to turn towards the north is called the *north-seeking pole* and the opposite one is called the *south-seeking pole*.

The name is usually abbreviated to simply the north and south poles. The north pole of a magnet is often indicated by a straight line or a letter N stamped into the metal.

A magnetized needle floating on a cork in a basin of water is a simple form of

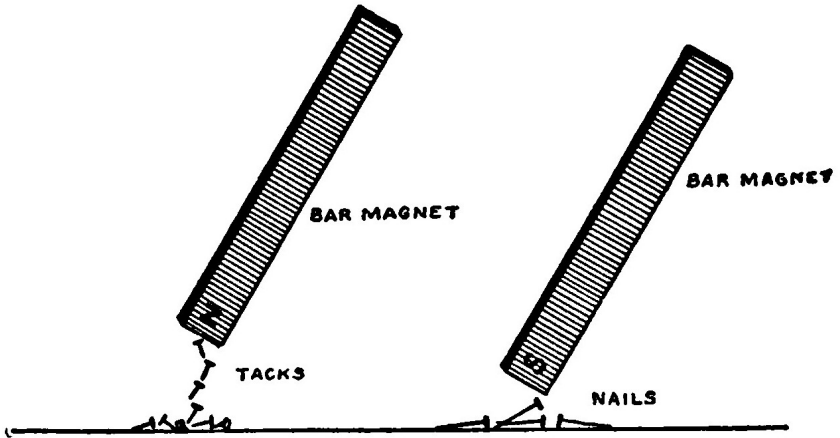

Fig. 5.—The Lifting Power of a Bar Magnet. It must be brought closer to the nails than the tacks because they are heavier.

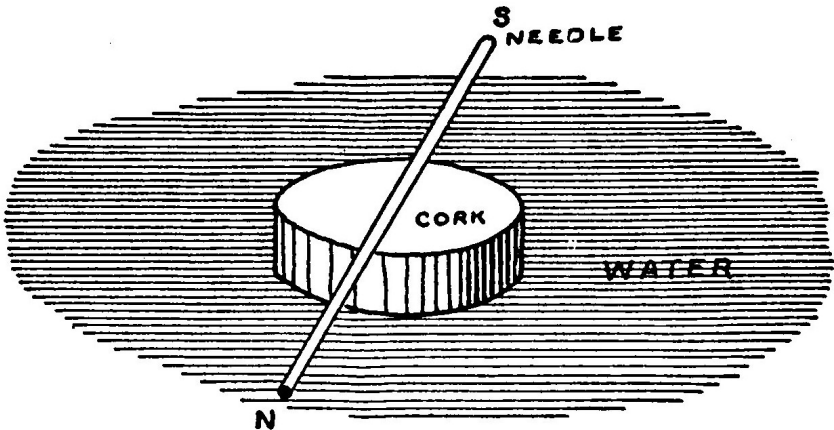

Fig. 6.—A Simple Compass.

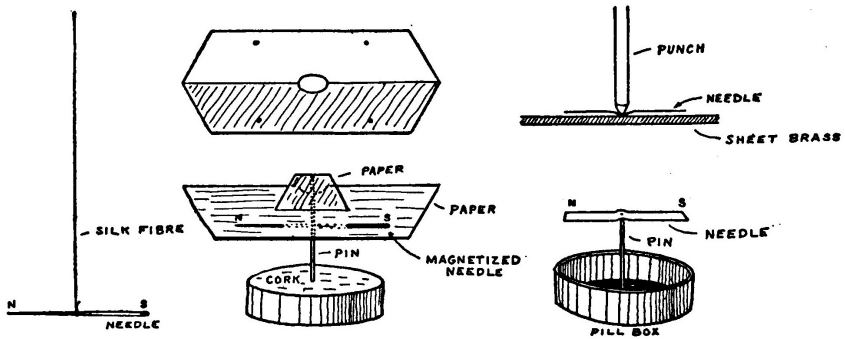

Fig. 7.—Several Different Methods of Making a Simple Compass.

Compass. Figure 7 shows several other different ways of making compasses. The first method is to suspend a magnetized needle from a fine silk fiber or thread.

The second method illustrates a very sensitive compass made from paper. Two magnetized needles are stuck through the sides with their north poles both at the same end. The paper support is mounted upon a third needle stuck through a cork.

A compass which more nearly approaches the familiar type known as a pocket compass may be made from a small piece of watch-spring or clock-spring.

The center of the needle is annealed or softened by holding it in the flame of an alcohol lamp and then allowing it to cool.

Lay the needle on a piece of soft metal such as copper or brass, and dent it in the center with a punch.

Balance the needle on the end of a pin stuck through the bottom of a pill-box.

Magnetic Substances are those which are attracted by a magnet. Experiment with a number of different materials, such as paper, wood, brass, iron, copper, zinc, rubber, steel, chalk, etc. It will be found that only iron and steel are capable of being attracted by your magnet. Ordinary magnets attract but very few substances. Iron, steel, cobalt, and nickel are about the only ones worthy of mention.

Attraction through Bodies. A magnet will attract a nail or a tack through a piece of paper, just as if nothing intervened.

It will also attract through glass, wood, brass, and all other substances. Through an iron plate, however, the attraction is reduced or entirely checked because the iron takes up the magnetic effect itself and prevents the force from

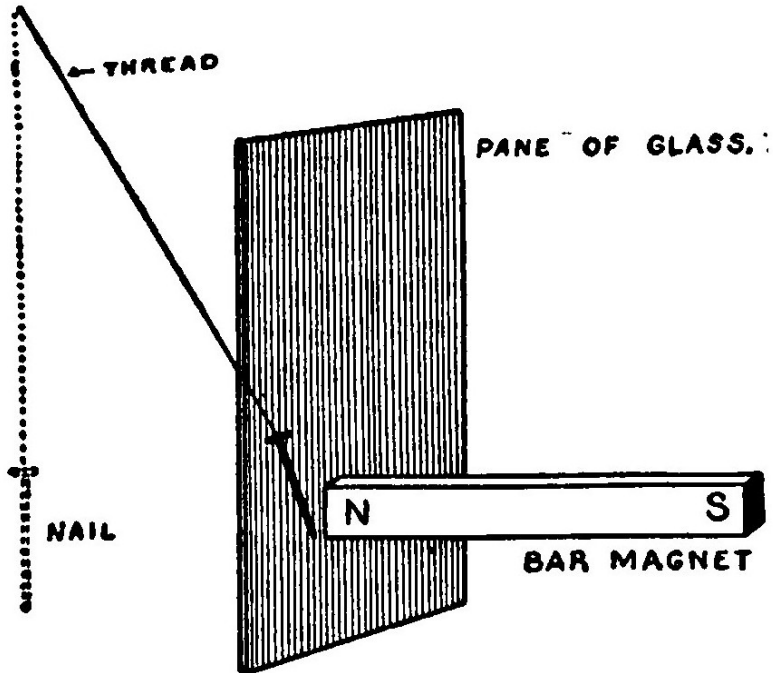

Fig. 8.—The Attraction of an Iron Nail through Glass.

passing through and reaching the nail.

A number of carpet-tacks may be supported from a magnet in the form of a chain. Each individual tack in the series becomes a *temporary* magnet by *induction*.

If the tack in contact with the magnet be taken in the hand and the magnet suddenly withdrawn, the tacks will at once lose their magnetism and fall apart.

It will furthermore be found that a certain magnet will support a certain number of tacks in the form of a chain, but that if a *second* magnet is placed beneath the chain, so that its south pole is under the north pole of the original magnet, the chain may be lengthened by the addition of several other tacks.

The reason for this is that the magnetism in the tacks is increased by induction.

Magnets will Attract or Repel each other, depending upon which poles are

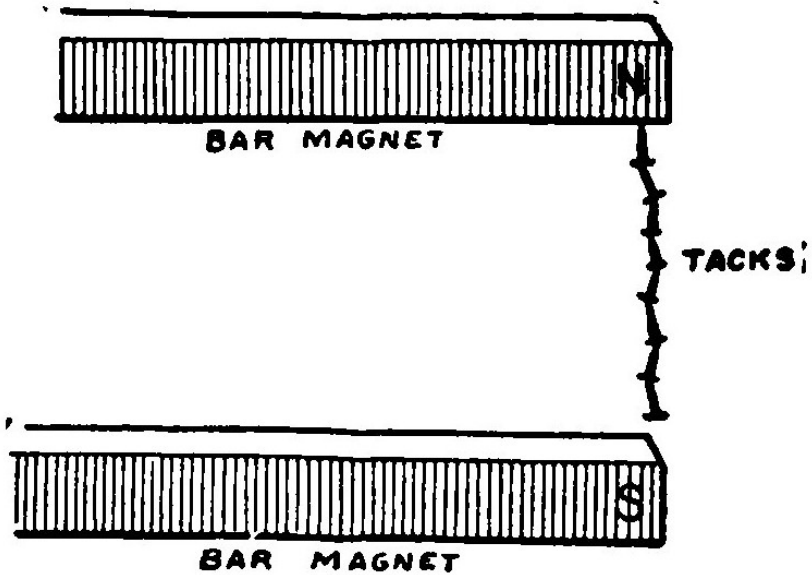

Fig. 9.—A Magnetic Chain.

nearest.

Magnetize a sewing-needle and hang it from a thread. Bring the north pole of a bar magnet near the lower end of the needle. If the lower end of the needle happens to be a south pole it will be attracted by the north pole of the bar magnet. If, on the other hand, it is a north pole, it will be repelled and you cannot touch it with the north pole of the bar magnet unless you catch it and hold it.

This fact gives rise to the general law of magnetism: *Like poles repel each other and unlike poles attract each other.*

Another interesting way of illustrating this same law is by making a small boat from cigar-box wood and laying a bar magnet on it. Place the north pole of the bar magnet in the bow of the boat.

Float the boat in a basin of water. Bring the south pole of a second magnet near the stern of the boat and it will sail away to the opposite side of the basin. Present the north pole of the magnet and it will sail back again.

If the south pole of the magnet is presented to the bow of the boat the little ship will follow the magnet all around the basin.

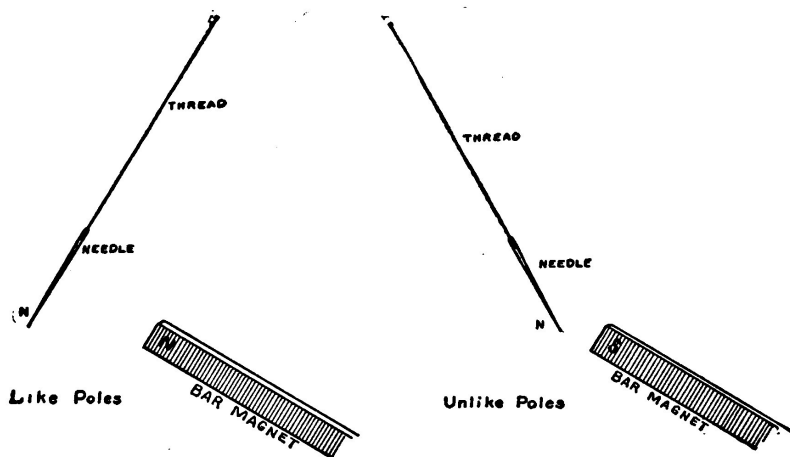

Fig. 10.—An Experiment Illustrating that Like Poles Repel Each Other and Unlike Poles Attract.

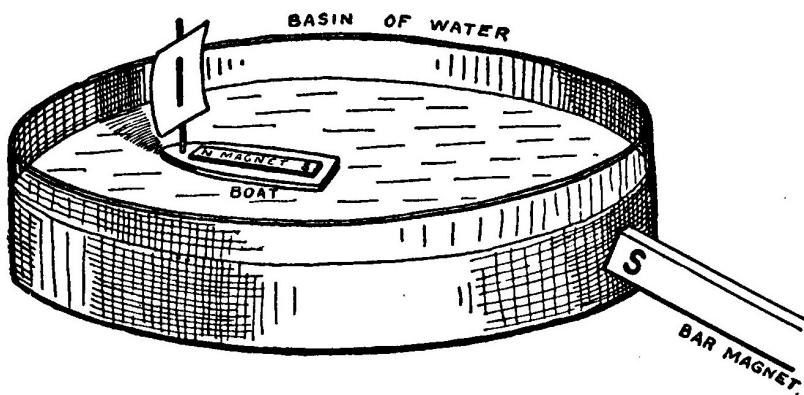

Fig. 11.—A Magnetic Boat.

The repulsion of similar poles may be also illustrated by a number of magnetized sewing-needles fixed in small corks so that they will float in a basin of water with their points down.

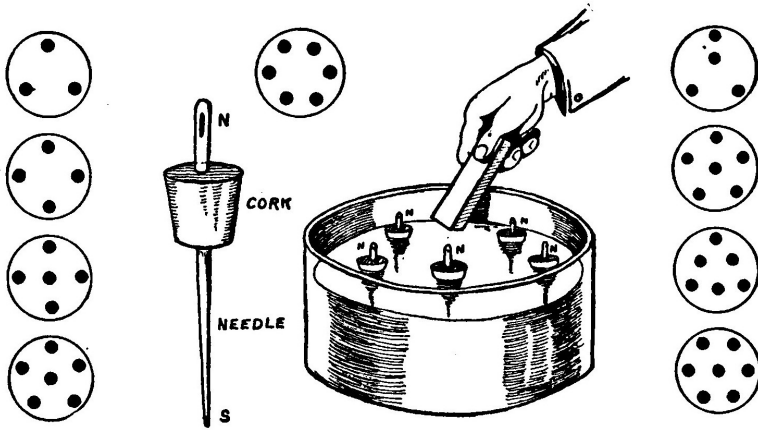

Fig. 12.—Repulsion between Similar Poles, Shown by Floating Needles.

The needles will then arrange themselves in different symmetrical groups, according to their number.

A bar magnet thrust among them will attract or repel them depending upon its polarity.

The upper ends of the needles should all have the same polarity, that is, all be either north or south poles.

Magnetism flows along certain lines called

Lines of Magnetic Force. These lines always form closed paths or circuits. The region in the neighborhood of a magnet through which these lines are passing is called the *field of force*, and the path through which they flow is called the

Magnetic Circuit. The paths of the lines of force can be easily demonstrated by placing a piece of paper over a bar magnet and then sprinkling iron filings over the paper, which should be jarred slightly in order that the filings may be drawn into the magnetic paths.

The filings will arrange themselves in curved lines, diverging from one pole of the magnet and meeting again at the opposite pole. The lines of force are considered as extending outward from the north pole of the magnet, curving

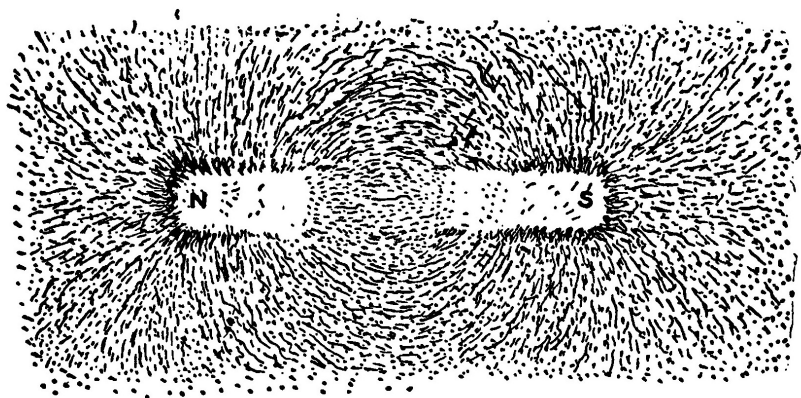

Fig. 13.—A Magnetic "Phantom," Showing the Field of Force about a Magnet.

around through the air to the south pole and completing the circuit back through the magnet.

Figure 14 shows the lines of force about a horseshoe magnet. It will be noticed that the lines cross directly between the north and south poles.

The difference between the magnetic fields produced by like and unlike poles is shown in Figure 15.

A study of this illustration will greatly assist the mind in conceiving how attraction and repulsion of magnetic poles take place.

It will be noticed the lines of force between two north poles resist each other and meet abruptly at the center. The lines between a north and a south pole pass in regular curves.

The Earth is a Great Magnet. The direction assumed by a compass needle is called the *magnetic meridian*.

The action of the earth on a compass needle is exactly the same as that of a permanent magnet. The fact that a magnetized needle places itself in the magnetic meridian is because the earth is a great magnet with lines of force passing in a north and south direction.

The compass needle does not generally point exactly toward the true North. This is because the magnetic pole of the earth toward which the needle points is not situated at the same place as the geographical pole.

Magnetic Dip. If a sewing-needle is balanced so as to be perfectly horizontal when suspended from a silk thread and is then magnetized, it will be found that it has lost its balance and that the *north* end points slightly downward.

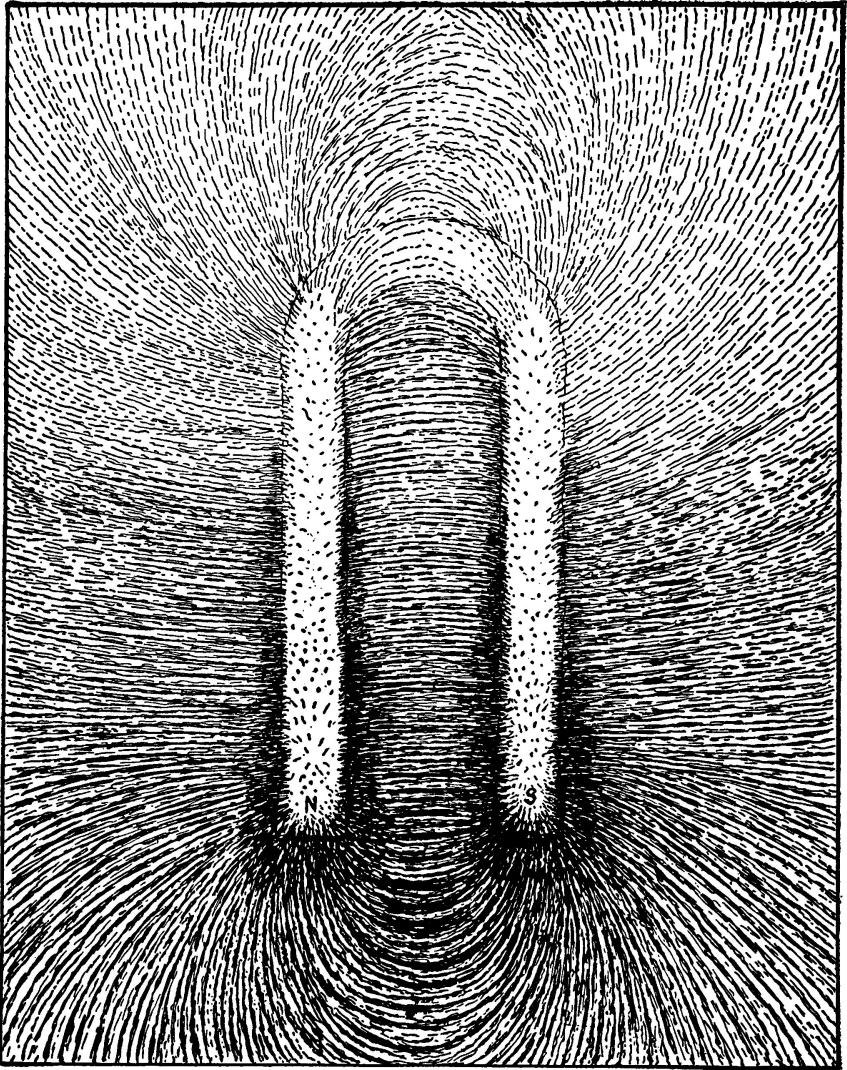

Fig. 14.—Magnetic Phantom showing the Lines of Force about a Horseshoe Magnet.

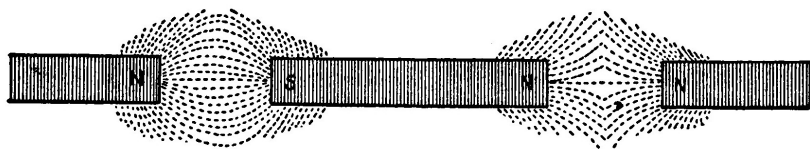

Fig. 15.—Lines of Force between Like and Unlike Poles.

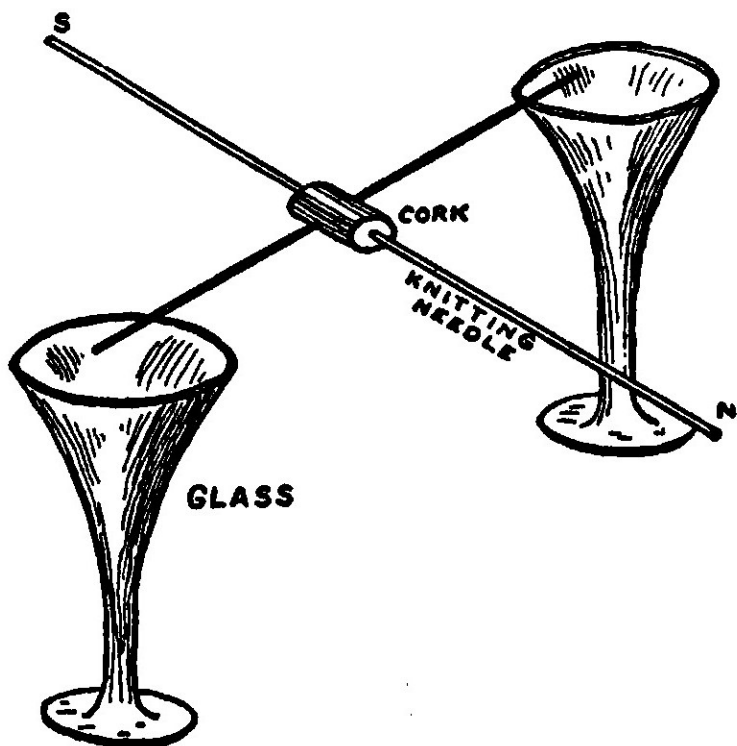

Fig. 16.—A Simple Dipping Needle.

This is due to the fact that the earth is round and that the magnetic pole which is situated in the far North is therefore not on a horizontal line with the compass, but below such a line.

A magnetic needle mounted so as to move freely in a vertical plane, and provided with a scale for measuring the inclination, is called a

Dipping Needle. A dipping needle may be easily made by thrusting a knitting-needle through a cork before it has been magnetized.

A second needle is thrust through at right angles to the first and the arrangement carefully balanced, so that it will remain horizontal when resting on the edge of two glasses.

Then magnetize the first needle by stroking it with a bar magnet. When it is again rested on the glasses it will be found that the needle no longer balances, but dips downward.

Permanent Magnets have a number of useful applications in the construction of scientific instruments, voltmeters, ammeters, telephone receivers, magnetos and a number of other devices.

In order to secure a very powerful magnet for some purposes a number of steel bars are magnetized separately, and then riveted together. A magnet made in this way is called a compound magnet, and may have either a bar or a horse-shoe shape.

Magnets are usually provided with a soft piece of iron called an armature or "keeper." The "keeper" is laid across the poles of the magnet when the latter is not in use and preserves its magnetism.

A blow or a fall will disturb the magnetic arrangement of the molecules of a magnet and greatly weaken it. The most powerful magnet becomes absolutely demagnetized at a red heat, and remains so after cooling.

Therefore if you wish to preserve the strength of a magnetic appliance or the efficiency of any electrical instrument provided with a magnet, do not allow it to receive rough usage.

CHAPTER II STATIC ELECTRICITY

If you take a glass rod and rub it with a piece of flannel or silk, it will be found to have acquired a property which it did not formerly possess: namely, the power of attracting to itself such light bodies as dust or bits of thread and paper.

Hold such a rod over some small bits of paper and watch them jump up to meet it, just as if the glass rod were a magnet attracting small pieces of iron instead of paper.

The agency at work to produce this mysterious power is called *electricity*,

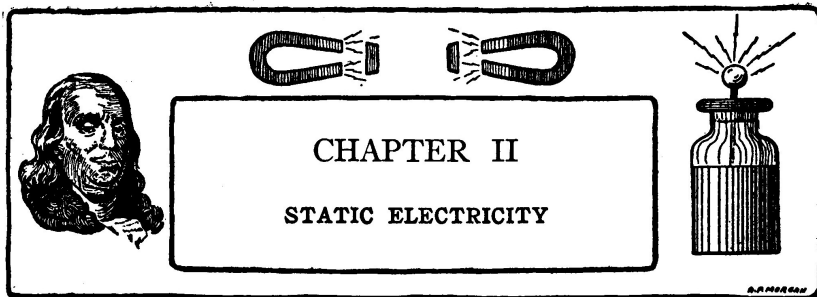

from the Greek word "Elektron," which means *amber*. Amber was the first substance found to possess this property.

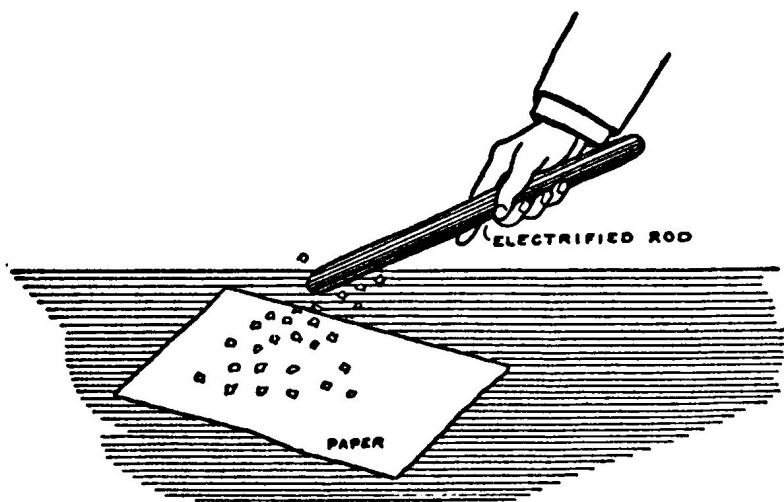

Fig. 17.—An Electrified Glass Rod will Attract Small Bits of Paper.

The use of amber begins with the dawn of civilization. Amber beads have been found in the royal tombs at Mycenae and at various places throughout Sardinia, dating from at least two thousand years before our era.

Amber was used by the ancient world as a jewel and for decoration.

The ancient Syrian woman used distaffs made of amber for spinning. As the

spindle whirled around it often rubbed against the spinner's garments and thus became *electrified*, as amber always does when it is rubbed. Then on nearing the ground it drew to itself the dust or bits of chaff or leaves lying there, or sometimes perhaps attracted the fringe of the clothing.

The spinner easily saw this, because the bits of chaff which were thus attracted would become entangled in her thread unless she were careful. The amber spindle was, therefore, called the "harpaga" or "clutcher," for it seemed to seize such light bodies as if it had invisible talons, which not only grasped but held on.

This was probably the first intelligent observation of an electrical effect.

In the eighteenth century, when Benjamin Franklin performed his famous kite experiment, electricity was believed to be a sort of fiery atmospheric discharge which could be captured in small quantities and stored in receptacles such as Leyden jars.

Franklin was the first to prove that the lightning discharges taking place in the heavens are electrical.

The story of his experiment is very interesting.

He secured two light strips of cedar wood, placed cross-wise and covered with a silk handkerchief for a kite. To the top of the upright stick of the kite was fastened a sharp wire about a foot long. The twine was of the usual kind, but was provided with a short piece of silk ribbon and a key. The purpose of the ribbon was possible protection against the lightning running through his body, silk being a "non-conductor," as will be explained a little farther on. The key was secured to the junction of the silk ribbon and the twine, to serve as a convenient conductor from which to draw the sparks—if they came. He did not have to wait long for a thunderstorm, and as he saw it gathering he went out with his son, then a young man twenty-two years of age. The great clouds rolled up from the horizon, and the gusts of wind grew fitful and strong. The kite felt a swishing blast and began to rise steadily, swooping this way and that as the breeze caught it. The thunder muttered nearer and nearer and the rain began to patter on the grass as the kite flew higher.

The rain soon began to fall heavily, compelling Franklin and his son to take refuge under a near-by shed. The heavy kite, wet with water, was sailing sluggishly when suddenly a huge low-lying black cloud traveling overhead shot forth a forked flame and the flash of thunder shook the very earth. The kite moved upward, soaring straight into the black mass, from which the flashes began to come rapidly.

Franklin watched the silk ribbon and the key. There was not a sign. Had he failed? Suddenly the loose fibers of the twine erected themselves. The moment had come. Without a tremor he advanced his knuckle to the key. And between his knuckle and the key passed a spark! then another and another. They were

the same kind of little sparks that he had made hundreds of times with a *glass tube*.

And then as the storm abated and the clouds swept off towards the mountains and the kite flew lazily in the blue, the face of Franklin gleamed in the glad sunshine. The great discovery was complete, his name immortal.

The cause of lightning is the accumulation of the electric charges in the clouds, the electricity residing on the surface of the particles of water in the cloud. These charges grow stronger as the particles of water join together and become larger. As the countless multitude of drops grows larger and larger the "potential" is increased, and the cloud soon becomes heavily charged.

Through the effects of a phenomenon called *induction*, and which we have already stumbled against in the experiment with the tacks and the magnetic chain, the force exerted by the charge grows stronger because of a charge of the opposite kind on a neighboring cloud or some object on the earth beneath. These charges continually strive to burst across the intervening air.

As soon as the charge grows strong enough a vivid flash of lightning, which may be from one to ten miles long, takes place. The heated air in the path of the lightning expands with great force; but immediately other air rushes in to fill the partial vacuum, thus producing the terrifying sounds called *thunder*.

In the eighteenth century, electricity was believed to be a sort of fiery atmospheric discharge, as has been said. Later it was discovered that it seemed to flow like water through certain mediums, and so was thought to be a fluid. Modern scientists believe it to be simply a vibratory motion, either between adjacent particles or in the ether surrounding those particles.

It was early discovered that electricity would travel through some mediums but not through others. These were termed respectively "conductors" and "non-conductors" or insulators. Metals such as silver, copper, gold, and other substances like charcoal, water, etc., are good conductors. Glass, silk, wool, oils, wax, etc., are non-conductors or insulators, while many other substances, like wood, marble, paper, cotton, etc., are partial conductors.

There seems to be two kinds of electricity, one called "static" and the other "current" electricity. The former is usually produced by friction while the latter is generated by batteries or dynamos.

A very simple and well-known method of generating static electricity is by shuffling or sliding the feet over the carpet. The body will then become *charged*, and if the knuckles are presented to some metallic object, such as a gas-jet or radiator, a stinging little spark will jump out to meet it.

The electricity is produced by the friction of the feet sliding over the carpet and causes the body to become electrified.

Warm a piece of writing-paper, then lay it on a wooden table and rub it



From the author's "Wireless Telegraphy and Telephony" by permission. A Double Lightning Discharge from a Cloud to the Earth.

briskly with the hand. It soon will become stuck to the table and will not slide along as it did at first. If one corner is raised slightly it will tend to jump right back. If the paper is lifted off the table it will tend to cling to the hands and the clothing. If held near the face it will produce a tickling sensation. All these things happen because the paper is electrified. It is drawn to the other objects because they are *neutral*, that is, do not possess an electrical charge.

All experiments with static electricity perform better in the winter time, when it is cool and clear, than in the summer. The reason is that the air in winter is drier than in summer. Summer air contains considerable moisture and water vapor. Water vapor is a *partial* conductor of electricity, and the surrounding air will therefore conduct the static electricity away from your apparatus almost as fast as it can be produced in the summer time.

Some day during the winter time, when it is cool and clear, and the cat is near a fire or a stove, stroke the cat rapidly with the hand. The fur will stand up towards the hand and a faint crackling noise will be heard. The crackling is

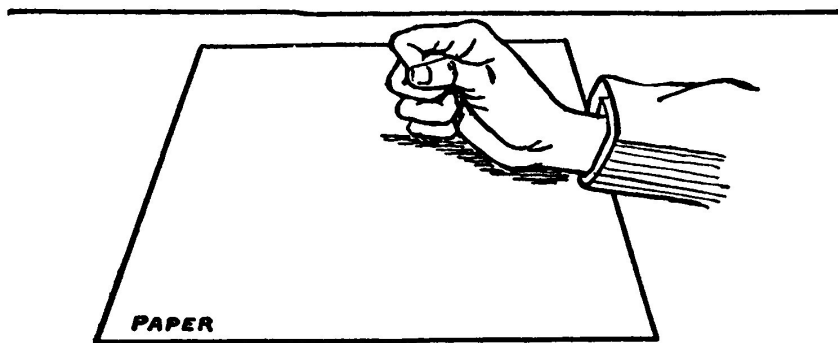

Fig. 19.—A Piece of Dry Writing-Paper may be Electrified by Rubbing.



Fig. 20.—A Surprise for the Cat.

caused by small sparks passing between the cat and the hand. If the experiment is performed in a dark room, the sparks may be plainly seen. If you present your knuckle to the cat's nose a spark will jump to your knuckle and somewhat surprise the cat.

If the day is brisk and cool, so that everything outside is frozen and dry, try combing the hair with a rubber comb. Your hair will stand up all over your head instead of lying down flat, and the faint crackling noise, showing that sparking is taking place as the comb passes through the hair, will be plainly heard. The electricity is produced by the friction between the hair and the comb.

Electricity may be produced by friction between a number of substances. A hard rubber rod, a glass rod, a rubber comb or a stick of sealing-wax may be very easily electrified by rubbing them briskly with a piece of dry, warm flannel.

Electroscopes are devices for detecting the presence of static electricity.

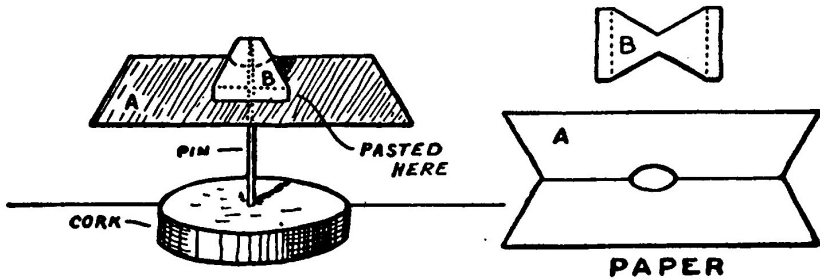

Fig. 21.—A Paper Electroscope.

A very simple form of electroscope may be made in much the same manner as the paper compass described in the last chapter. It may be cut out of writing-paper and mounted on a pin stuck through a cork. If an electrified rod is held near the electroscope it may be made to whirl around in the same manner as a compass needle when a bar magnet is brought to it.

The **Pith-Ball Electroscope** is a very simple device, in which a ball of cork or elder pith is hung by a fine silk thread from an insulated support. A suitable electroscope may be made from a glass bottle having a piece of wire thrust into the cork to support the pith ball. When the electrified rod is presented to the pith ball, it will fly out towards the rod.

If the pith ball is permitted to touch the glass rod, the latter will transfer some of its electricity and charge the ball. Almost immediately the pith ball will fly away from the glass rod, and no matter how near the rod is brought, it will

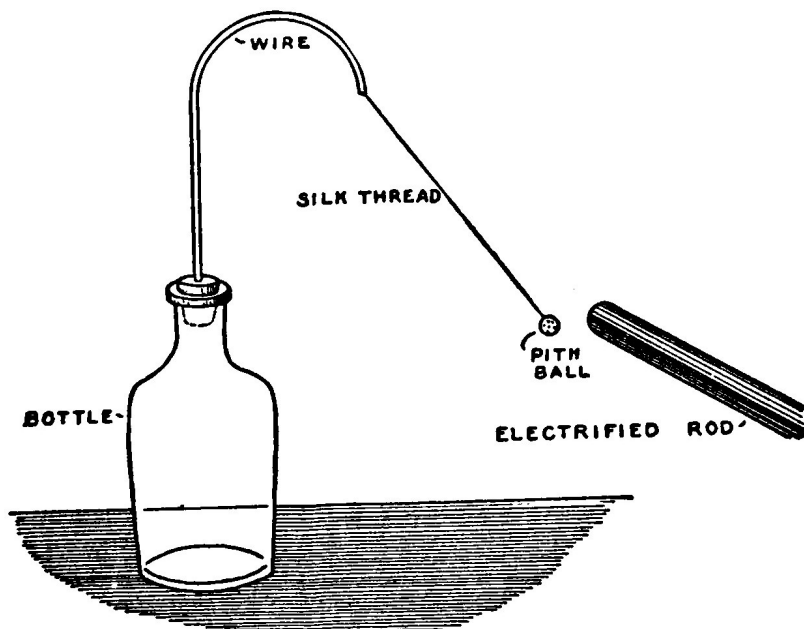

Fig. 22.—A Pith-Ball Electroscope.

refuse to be touched again.

This action is much the same as that of the magnetized needle suspended from a thread when the similar pole of the magnet is presented to it.

When the rod is first presented to the pith ball, the latter is neutral and does not possess an electrical charge. When the rod has touched the ball, however, some of the electricity from the rod passes to the ball, and after this they will repel each other.

The reason is that the rod and the ball are *similarly* charged and *similarly charged bodies will repel each other*.

If you are a good observer you might have noticed when experimenting with an electrified rod and the small bits of paper, that some of the little papers were first attracted and flew upwards to the rod, but having once touched it, were quickly repelled.

The repulsion between two similarly electrified bodies may be shown by a

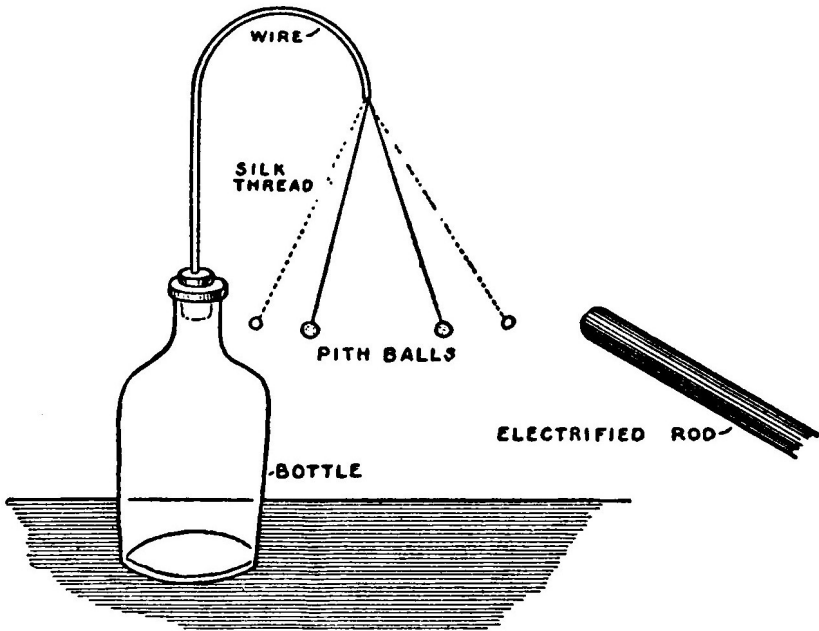

Fig. 23.—A Double Pith-Ball Electroscope.

double electroscope.

A double electroscope is made by hanging two pith balls on two silk threads from the same support.

Electrify a glass rod and touch it to the pith balls. They will immediately fly apart because they are electrified with the same kind of electricity.

The **Gold-leaf Electroscope** is one of the most sensitive means which can be employed to detect small amounts of static electricity.

It is a very simple instrument and is easily made in a short time. A couple of narrow strips of the thinnest tissue paper, or, better still, two strips of gold leaf, are hung from a support in a wide-mouthed glass bottle which serves at once to insulate and protect the strips from draughts of air.

The mouth of the jar is closed by a plug of paraffin wax, through the center of which passes a small glass tube. A stiff copper wire passes through the tube. The lower end of the wire is bent at right angles to furnish support for the strips of gold leaf. A round sheet metal disk about the size of a quarter is soldered to

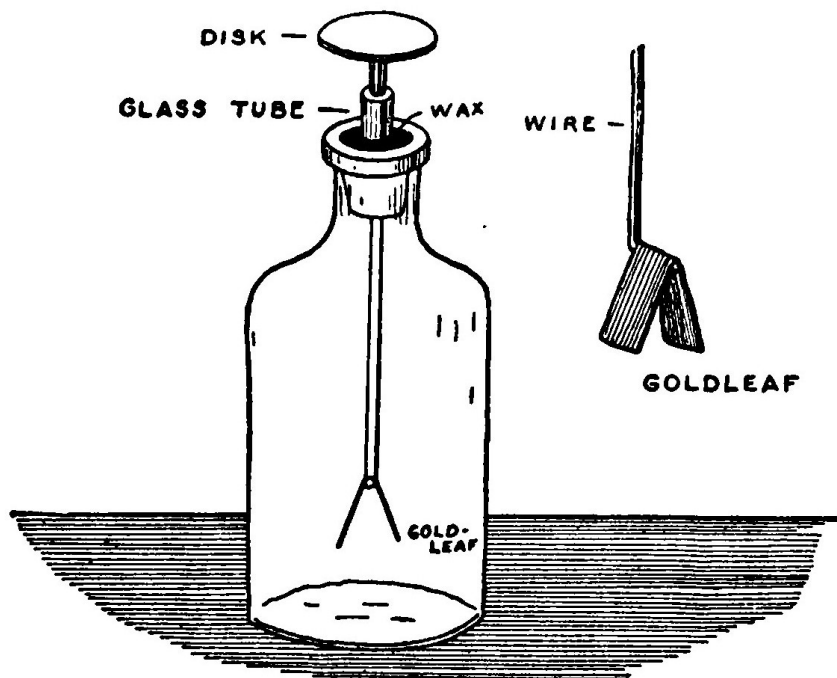

Fig. 24.—A Gold-Leaf Electroscope.

the upper end of the rod.

If an electrified stick of sealing-wax or a glass rod is presented to the disk of the electroscope, the strips will repel each other very strongly. If the instrument is sensitive, the strips should begin to diverge some time before the rod reaches the disk. It is possible to make an electroscope so sensitive that chips formed by sharpening a pencil will cause the strips to diverge.

There are two kinds of static electricity. Rub a glass rod with a piece of silk and then suspend it in a wire stirrup as shown in Figure 25. Excite a second rod also with a piece of silk and bring it near one end of the suspended one. The suspended rod is *repelled* and will swing away from the one held in the hand.

Now rub a stick of *sealing-wax* with a piece of *flannel* until the sealing-wax is electrified. Then bring the stick of sealing-wax near the end of the suspended rod. The rod will be *attracted* to the sealing-wax.

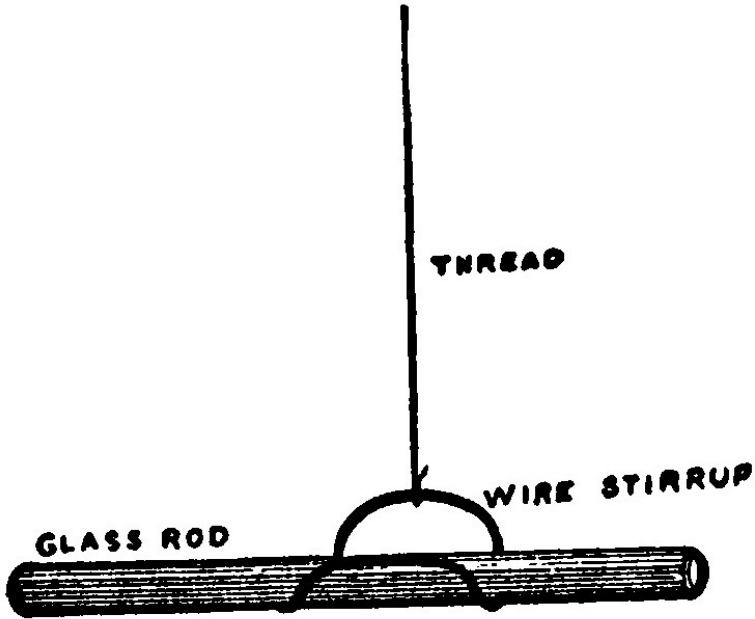

Fig. 25.—Method of Suspending an Electrified Rod in a Wire Stirrup.

If you experiment further you will find that two sticks of sealing-wax will repel each other.

This experiment indicates that there are two kinds of electrification: one developed by rubbing glass with silk and the other developed by rubbing sealing-wax with flannel.

In the first instance, the glass rod is said to be *positively* electrified, and in the latter case the sealing-wax is *negatively* electrified.

The same law that applies to magnetism also holds true in the case of static electricity, and similarly electrified bodies will repel each other and dissimilar ones attract.

The **Electrophorus** is an instrument devised by Volta in 1775 for the purpose of obtaining static electricity.

It is easily constructed and will furnish a source of electricity for quite a number of interesting experiments. An electrophorus consists of two parts, a round cake of resinous material cast in a metal dish or pan, and a round metal

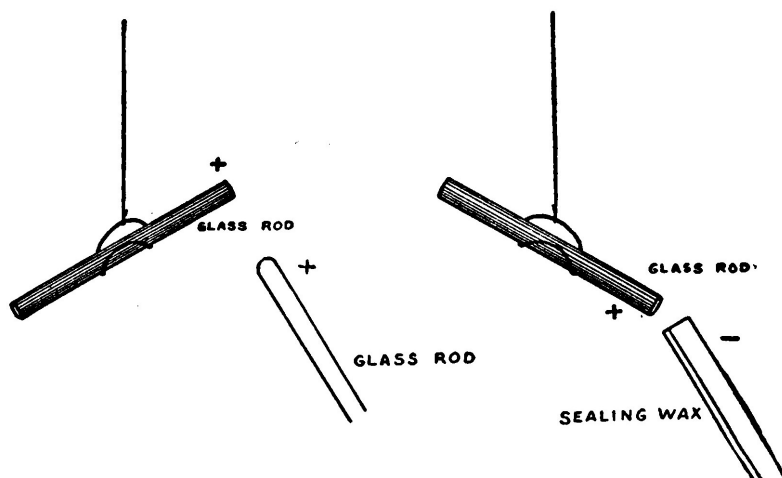

Fig. 26.—Similarly Electrified Bodies Repel Each Other. Dissimilarly Electrified Ones Attract Each Other.

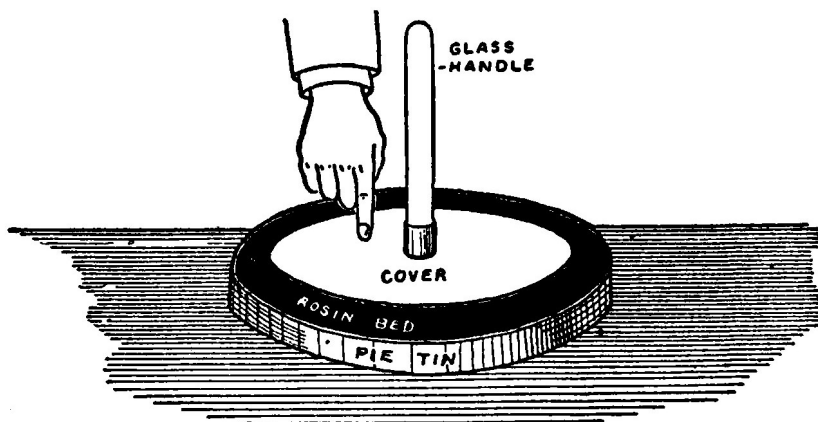

Fig. 27.—The Electrophorus

disk which is provided with an insulating handle.

To make an electrophorus, first procure an old cake or pie tin, and fill it with bits of resin or sealing-wax. Place the pan in a warm spot upon the stove where the resin will melt, taking care not to overheat or it will spatter and possibly take fire. As the resin melts, add more until the pan is nearly full. When all is melted, remove from the fire and set it away where it may cool and harden in the pan without being disturbed.

Cut a circular disk out of sheet tin, zinc, or copper, making the diameter about two inches less than that of the pie pan. Solder a small cylinder of tin or sheet brass to the center of the disk to aid in supporting the handle. The latter is a piece of glass tubing about three-quarters of an inch in diameter and four or five inches long, placed in the center of the cylinder and secured with molten sealing-wax.

In order to use the electrophorus the resinous cake must first be beaten or briskly rubbed with a piece of warm woolen cloth or flannel. Then place the disk on the cake holding the insulating handle with the right hand. Touch the cover or the disk momentarily with the forefinger of the left hand. After the finger is removed, raise the disk from the cake by picking it up with the glass insulating handle. The disk will now be found heavily charged with positive electricity, and if the knuckles are presented to the edge, a spark will jump out to meet them.

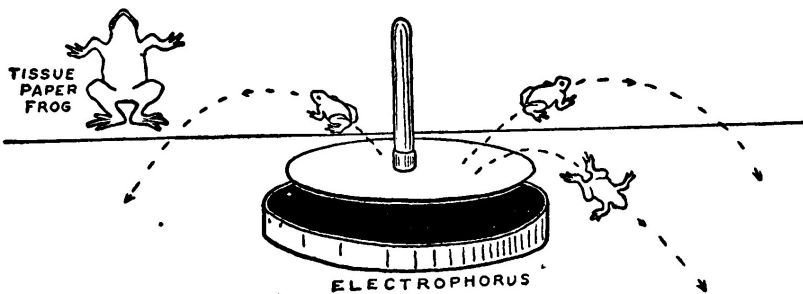
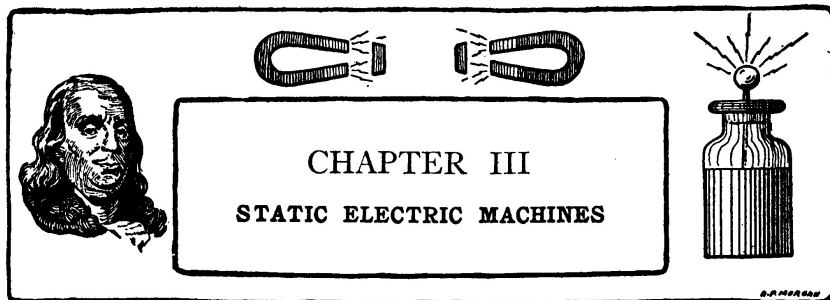

Fig. 28.—An Electric Frog-Pond.

The cover may then be replaced, touched, and once more removed. It will yield any number of sparks, the resinous cake only needing to be recharged by rubbing once in a long while.

An Electric Frog-Pond may be experimented with by cutting out some small tissue-paper frogs. Moisten them a little and lay them on the cover of the elec-

trophorus. Touch the electrophorus with the finger and then raise it with the insulating handle. If the "frogs" are not too wet they will jump from the cover upon the table as soon as the cover is raised.



CHAPTER III STATIC ELECTRIC MACHINES

A Cylinder Electric Machine

The electrophorus described in the last chapter is capable of furnishing sufficient electricity for many interesting experiments, but for the purpose of procuring larger supplies of electricity, a static electric machine is necessary.

An electric machine is composed of two parts, one for producing the electricity by the friction of two surfaces rubbing against each other, and the other an arrangement for collecting the electricity thus formed.

The earliest form of electric machine consisted of a ball of sulphur fixed upon a spindle which could be rotated by means of a crank. When the dry hands were pressed against the sulphur by a person standing on a cake of resin, which insulated him, sparks could be drawn from his body.

Later a leather cushion was substituted for the hands, and a glass cylinder for the ball of sulphur, so that the frictional electric machine now consists of a cylinder or a disk of glass mounted upon a horizontal axis capable of being turned by a handle. A leather cushion, stuffed with horsehair and covered with a powdered amalgam of zinc or tin, presses against one side of the cylinder. A "prime" conductor in the shape of an elongated cylinder presents a row of fine metal spikes, like the teeth of a rake, to the opposite side. A flap of silk attached to the leather cushion passes over the cylinder and covers the upper half.

When the handle of the machine is turned, the friction produced between

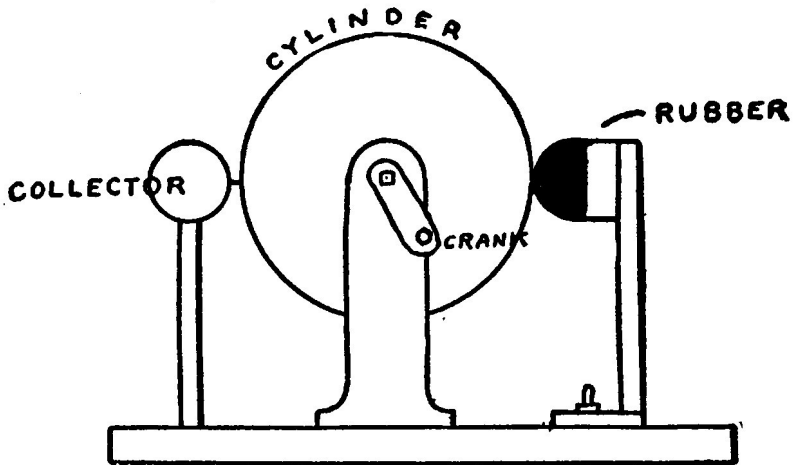

Fig. 29.—Front View of a Cylinder Electric Machine.

the leather cushion and the glass generates a supply of positive electricity on the glass, which is collected, as the cylinder revolves, by the row of sharp points, and transferred to the prime conductor.

The first thing required in the construction of an electric machine is a large glass bottle having a capacity of from two to four quarts.

The insulating power of glass varies considerably. Common green glass (not white glass colored green by copper, but glass such as the telegraph insulators are made from) generally insulates the best. Some sorts of white glass, the Bohemian especially, are good insulators, but this quality will not usually be found in ordinary bottles.

Select a smooth bottle which has no lettering embossed upon it, and stand it upon a piece of white paper. Trace on the paper a line around the circumference of the bottle so that the circle thus formed is of the same size as the bottom of the bottle. Lay a carpenter's square on the circle so that the point *C* just touches the circumference. Draw a line from *A* to *B* where the sides of the square cut the circumference. The point in the middle of this line is the center of the circle.

Place the paper on the bottom of the bottle so that the circle coincides with the circumference, and mark the center of the bottle.

The bottle must now be drilled. This is accomplished with a small three-

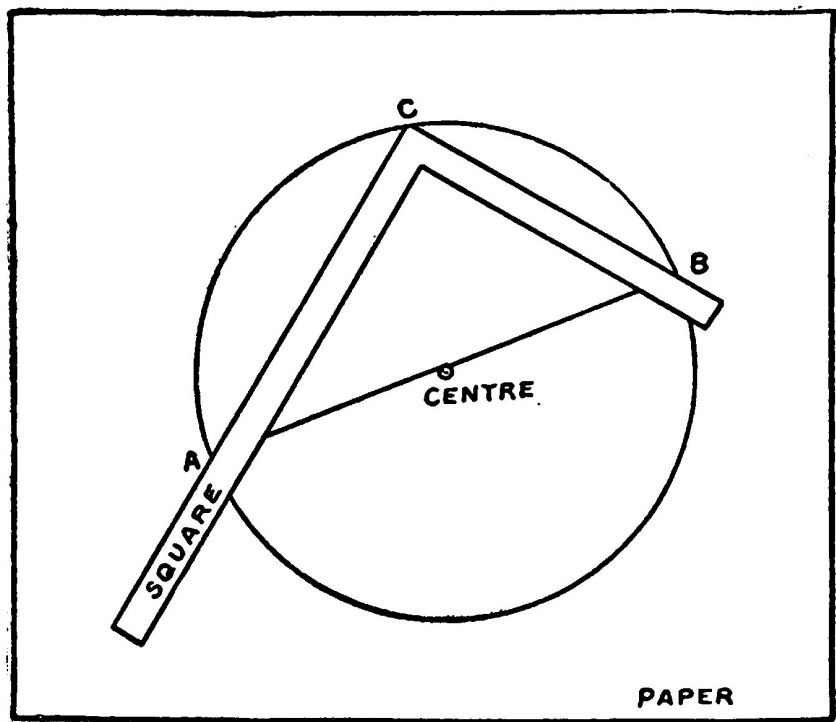

Fig. 30.—Method of Finding the Center of a Circle.

cornered file, the end of which has been broken off so as to form a ragged cutting edge. The file is set in a brace and used like an ordinary drill. During the boring process the drill must be frequently lubricated with a mixture of gum camphor and turpentine. The drilling, which will require almost an hour before the glass is pierced, if the bottle is a thick one, should be performed slowly and carefully, so as to avoid all danger of cracking the glass. The hole, when finished, should be from one-quarter to three-eighths of an inch in diameter.

After the hole has been bored, fit a wooden plug into the neck of the bottle and cement it there with a mixture composed of one-half a pound of resin, five ounces of beeswax, one-quarter of an ounce of plaster of Paris, and three-quarters of an ounce of red ocher, melted together over a moderately warm stove. Dip the plug in the molten cement and force it into the neck of the bottle. When the

cement dries it will be impossible to remove it.

The sizes of bottles vary, so that it is quite impossible to give dimensions which must be closely followed in constructing the machine. Those in the text are approximate. The drawings have been made to scale so as to show the proportions the parts bear to each other.

A heavy wooden base will be required to mount the machine on. Two uprights are mounted on the base to support the axis of the bottle. Through one of these bore a hole of the same diameter as the wooden plug fitted in the neck of the bottle. The end of the wooden plug projecting through the upright is notched and fitted with a crank so that the bottle may be revolved. The handle of the crank is an ordinary spool having one flange cut off and mounted with a screw and a washer.

The machine is now ready for the "rubber" and "prime conductor." The rubber is a piece of wood one inch square and from six to eight inches long. A piece of undressed leather is tacked on as shown in the illustration and stuffed with horsehair. The wood is shellacked and covered with tin-foil previous to tacking on the leather. A strip of wood, two inches wide and one-half an inch thick, is fastened to the back of the rubber. The strip should be just long enough so that when the lower end rests on the base the rubber is level with the axis of the bottle. The lower end may be fastened to the base by means of a small brass hinge. Two rubber bands stretch from hooks between the rubber and the base so as to pull the former tightly against the bottle. The illustration shows a method of mounting the rubber on a foot-piece held to the base with a thumb-nut so that it may be slid back and forth and the pressure varied at will.

The prime conductor is formed from a piece of curtain-pole two inches in diameter and eight inches long. The ends are rounded with a rasp and then smoothed with sandpaper. The whole surface is then shellacked and covered with a layer of tinfoil. The heads of a number of dressmaker's pins are cut off, and the pins forced into the side of the prime conductor with a pair of pincers. They should form a row like the teeth of a rake about three-eighths of an inch apart. A hole is bored in the center of the under side of the prime conductor to receive a glass rod one-half inch in diameter. A second hole of the same size is bored in the base in such a position that when the glass rod is in place, the teeth on the prime conductor are on a level with the axis of the bottle, and their points about $\frac{3}{32}$ of an inch away from the glass. The glass rod must be used in order to insulate the prime conductor and prevent the escape of the electricity. It is secured with some of the cement described on page 33. A piece of water-gauge glass may be used in place of a glass rod.

A strip of oiled silk, or in its place a strip of silk which has been shellacked, eight or nine inches wide, and long enough to reach half-way around the bottle,

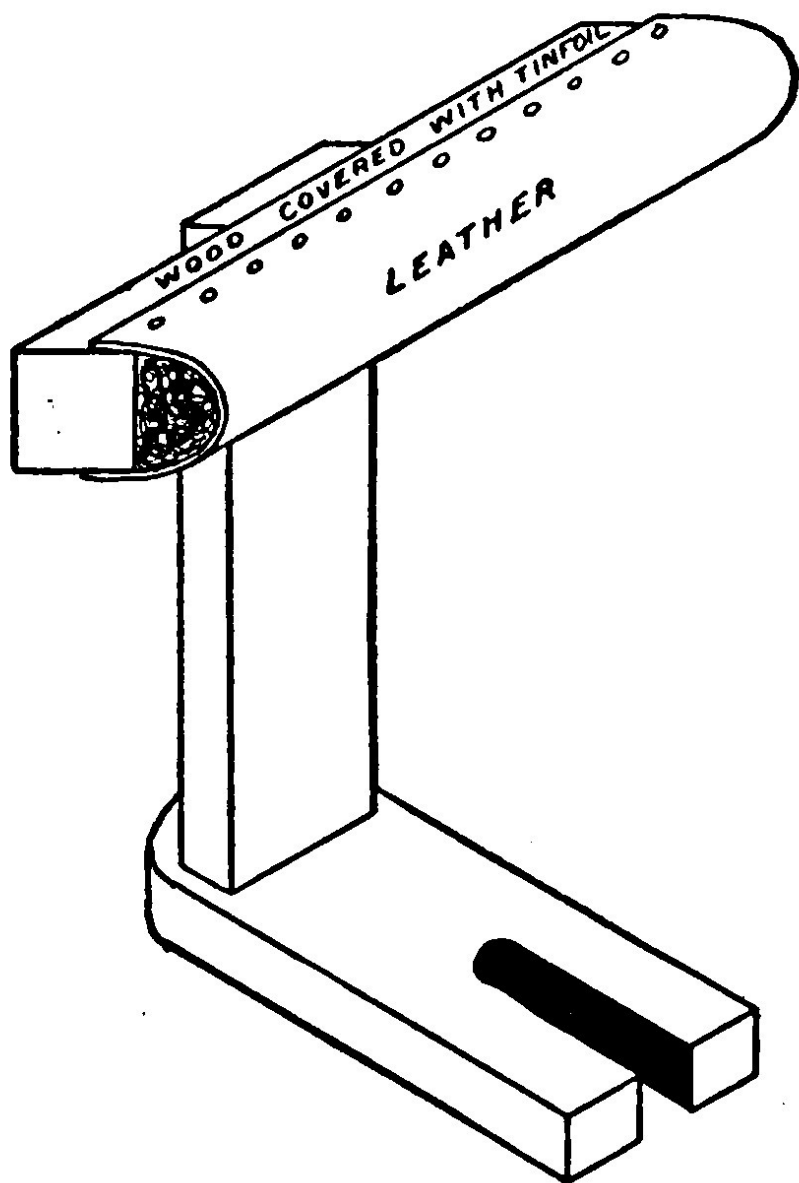

Fig. 31.—The "Rubber."

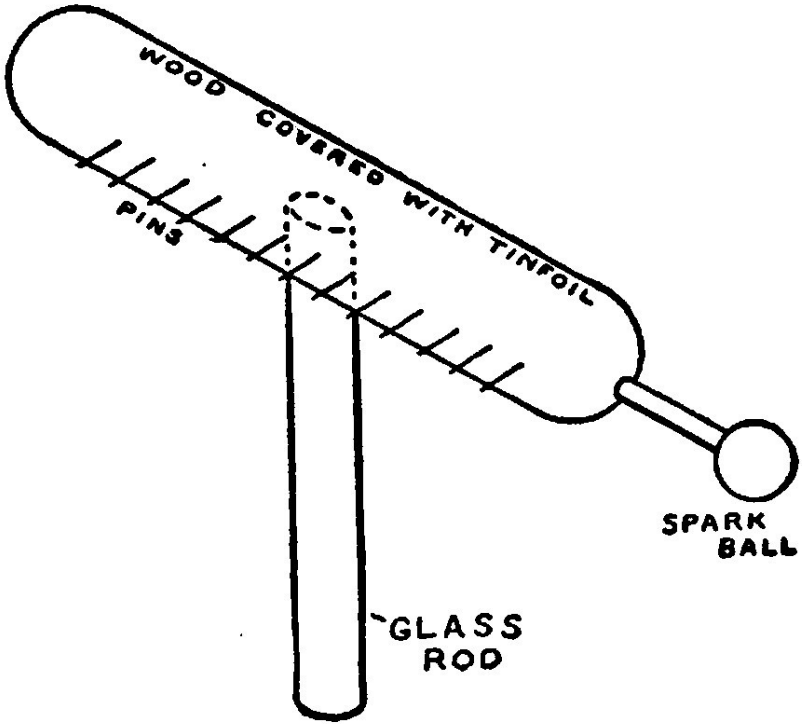

Fig. 32.—The Prime Conductor or Collector.

is tacked to the rubber so that the silk covers the upper half of the cylinder and comes over to within one-quarter of an inch of the steel points.

The machine is now complete, and when the handle is turned rapidly, you will be able to draw sparks from the prime conductor. The sparks will probably be very short, about one-half of an inch long. These can be increased, however, to three inches, if the glass is of the right quality, by treating the rubber with amalgam.

The amalgam is formed by melting one ounce of tin and adding to it one ounce of zinc in small bits. As soon as the zinc has also melted add to the mixture two ounces of mercury which has been previously warmed. Be careful not to inhale any of the vapor during this operation. Pour the mixture into a vessel of cold water, which will reduce the metal to small grains. Pour off the water and grind the amalgam to a powder by pounding the grains with a hammer.

The leather rubber should be *thinly* smeared with lard and the powdered amalgam rubbed on it.

In order to obtain the greatest effect from an electric machine, it must be carefully freed from dust and particles of amalgam adhering to the glass, and the insulating column rubbed with a warm woolen cloth. The best results are obtained by placing the machine near a stove or radiator where it is warm.

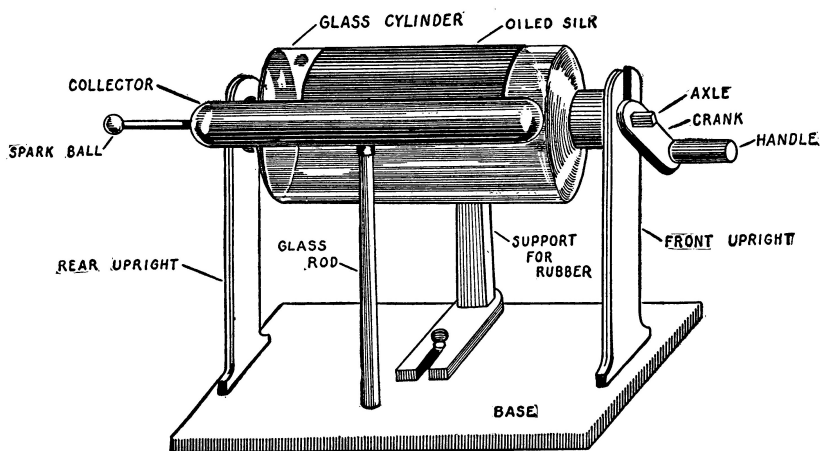

Fig. 33.—The Complete Cylinder Electric Machine.

A Wimshurst Machine

The Wimshurst Machine consists of two varnished glass plates revolving in opposite directions. On the outside of each of these plates are cemented a number of tinfoil "sectors," arranged radially. Two conductors at right angles to each other extend obliquely across the plates, one at the back and the other at the front. These conductors each terminate in brushes of tinsel which electrically excite the "sectors" as the plates revolve. The electricity is collected by a set of "collectors" arranged in a somewhat similar manner to the collector on the cylinder electric machine.

The Glass Plates are each eighteen inches in diameter. Purchase two panes of clear glass twenty inches square from a glass dealer. The white glass is far preferable to the green glass and will make the best electric machine. The plates should be of the thickness known as "single light" and should be perfectly free from wavy places, bubbles, or other imperfections.

The work is first laid out on a piece of stiff paper twenty inches square as a pattern. Describe a circle four inches in diameter. Using the same center, draw other circles, making them respectively eight, sixteen, and eighteen inches in diameter. Then mark sixteen radial lines, from the center, making them equal distances apart, as shown in Figure 34.

Lay one of the glass panes over the pattern and cut out a glass circle eighteen inches in diameter, or perhaps you may be able to have a glazier do the cutting for you and so save considerable trouble and possible breakage. Two such plates should be made.

The Sectors are cut from heavy flat tinfoil according to the pattern shown in Figure 35. They should be made one inch and one-half wide at the wide end and three-quarters of an inch at the other end. They are each four inches long. Thirty-two such sectors are required. The easiest way to make them is to cut out a pattern from heavy cardboard to serve as a guide.

Clean and dry both of the glass plates very carefully and then give them each two thin coats of white shellac. After they have been dried, lay one of the plates on the paper pattern so that the outside of the plate will coincide with the largest circle on the paper.

Then place a weight in the center of the plate so that it will not move, and stick sixteen of the tinfoil sectors on the plate with thick shellac. The sectors are arranged symmetrically on the plate, using the eight-inch and sixteen-inch circles and the radial lines as guides. Both plates should be treated in this manner. Each sector should be carefully pressed down on the glass, so that it will stick smoothly without air-bubbles or creases. When all the sectors are in place the plates will appear like that shown in Figure 35.

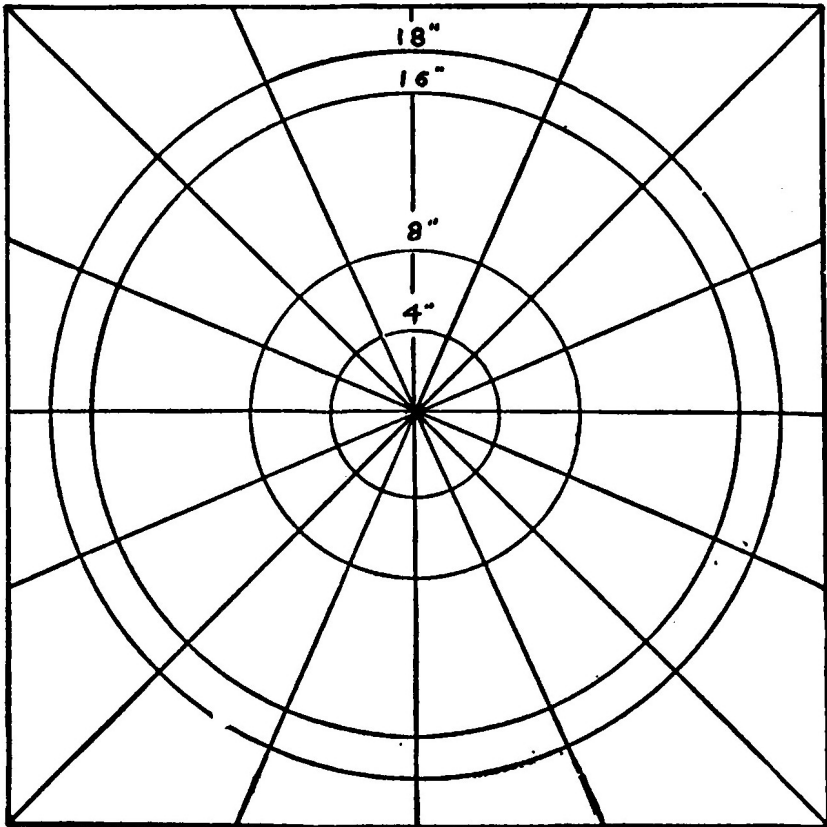

Fig. 34.—Paper Pattern for laying out the Plates.

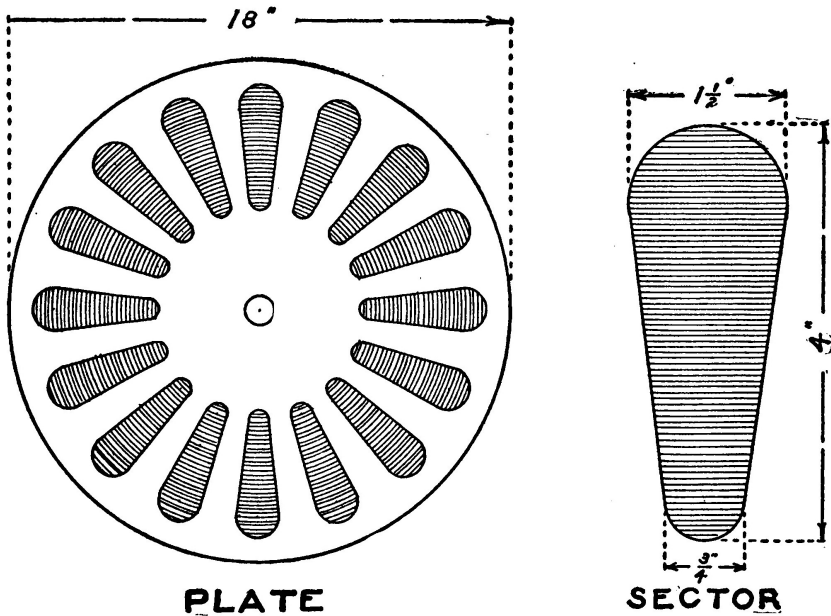

Fig. 35.—Plate with Sectors in Position, and a Pattern for the Sectors.

The Bosses will have to be turned out at a wood-working mill or at some place where they have a turning-lathe. The bosses are four inches in diameter at the large end and one inch and one-half at the other. A groove is turned near the small end of each to accommodate a round leather belt.

A hole should be made in each boss about half-way through from the small end. These holes should be bushed with a piece of brass tubing having an inside diameter of one-half inch. The tubing should go into the hole very snugly and be a "driven fit."

The bosses should both be given a coat of shellac, and after this is dry, fastened to the glass plates on the same side to which the tinfoil sectors are attached. The best plan is to lay the disks on the paper pattern and adjust them until the outer edge coincides with the largest circle.

Then apply some *bichromate glue* to the flat surface of one of the bosses and place the latter in the center of the plate in line with the smallest circle.

Place a weight on the boss to hold it down firmly against the plate and leave

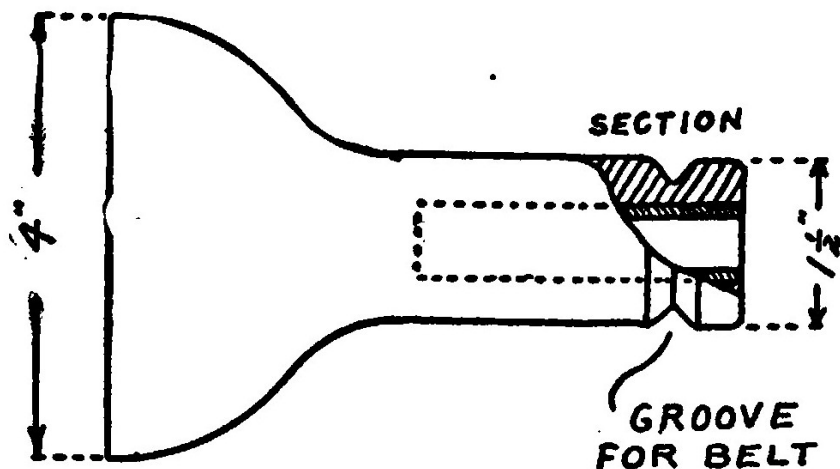

Fig. 36.—A Side View of one of the Bosses, showing the Brass Bushing used.

it over night, or for ten or twelve hours, until thoroughly dry.

The glue is prepared by placing some high-grade glue in a tin cup and covering it with cold water. Allow it to stand until the glue absorbs all the water it will and becomes soft. Then pour the water off and add enough *glacial acetic acid* to cover the glue.

Heat the mixture until it is reduced to a liquid, stirring it until it is perfectly smooth. Add a teaspoonful of powdered bichromate of potash to the glue.

The glue must now be kept in the dark, for sunlight will "set" the glue so that it becomes insoluble.

The Frame of the machine is composed of two strips twenty-five inches long, three inches wide, and an inch and one-half in thickness, and two cross-pieces of the same thickness and width fifteen inches long.

Notches are cut at both sides of the base to admit the feet of the uprights.

The Uprights are seventeen inches long, three inches wide, and one and one-half inches thick.

The notch at the foot is cut the same width as the thickness of the long members of the frame and is arranged so that when fitted in place, the foot of the upright will rest on the table in line with the bottom of the cross-pieces.

The Driving-Wheels are turned out of wood on a lathe. They are seven

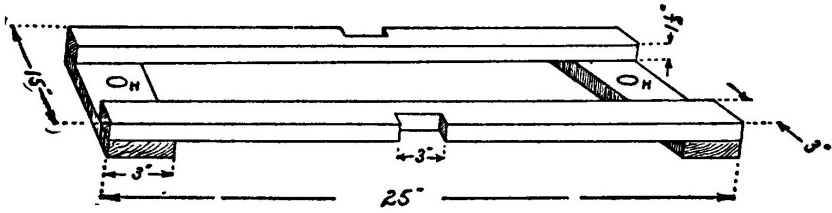

Fig. 37.—The Frame.

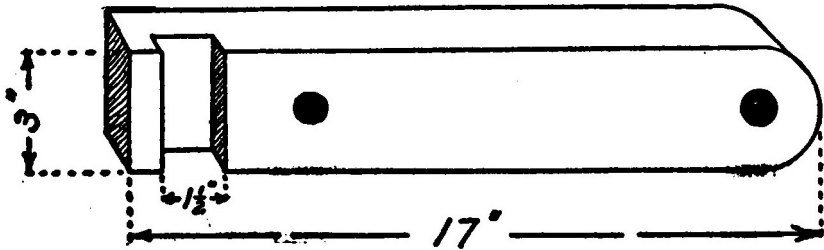

Fig. 38.—The Upright.

inches in diameter and seven-eighths of an inch thick. A groove should be turned in the edge to carry a small round leather belt. The wheels are mounted on a wooden axle made from a round curtain-pole. They are glued to the axle and arranged so that the grooves will fall directly underneath the pulleys turned in the bosses.

The ends of the axle pass through the uprights, five inches above the bottom.

The front end of the axle is fitted with a crank and a handle.

The plates are mounted on short iron axles passing through the top of the upright into the brass bushings. One end of each of the axles is filed flat where it passes through the wood upright so that it may be firmly held by a set-screw and prevented from revolving.

Fasten a small fiber washer to the center of one glass disk so that it will separate the plates and prevent them from touching when revolving.

The collectors, quadrant rods, etc., are mounted on glass rods one inch in diameter. The bottoms of the rods fit in holes (*HH*) bored in the cross-pieces of

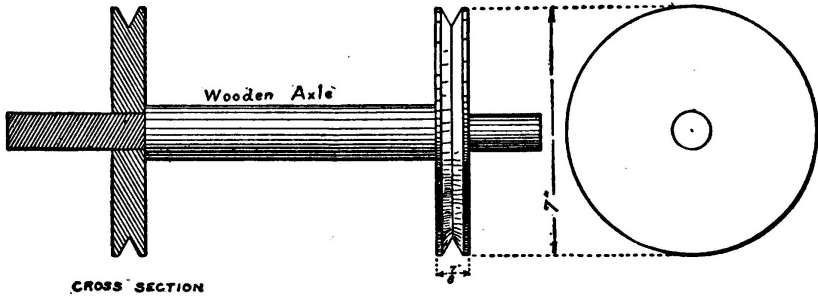

Fig. 39.—The Driving-Wheels and Axle.

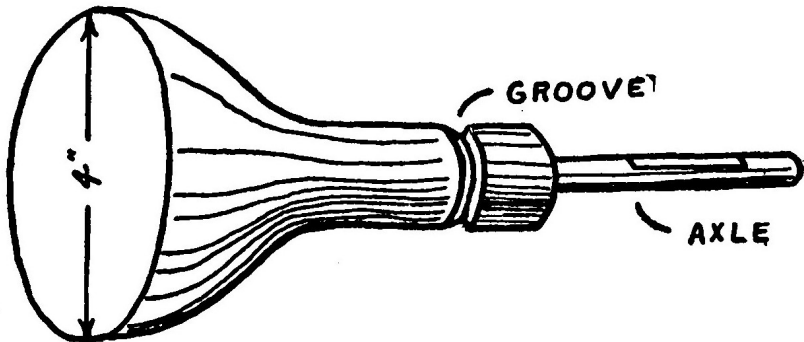

Fig. 40—The Boss and Axle. For sake of clearness, the Plate is not shown.

the base, Figure 37. The upper ends are each fitted with a brass ball two inches in diameter. The balls are mounted on the rods by soldering a piece of brass tubing to the ball and slipping it over the rod. The rods should be of the proper length to bring the center of the balls on a line with the center of the plates.

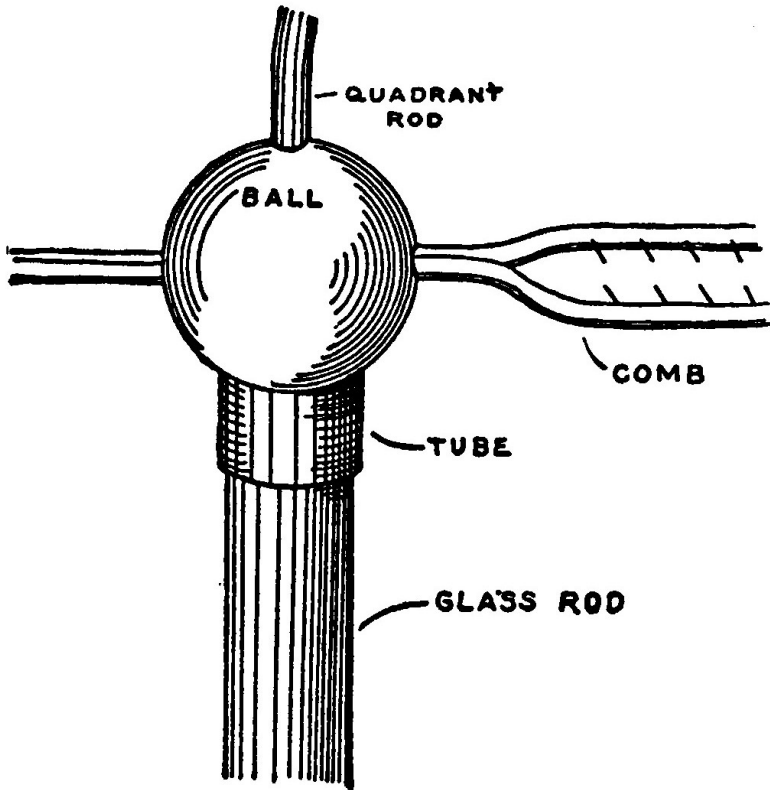

Fig. 41—Showing how the Ball, Comb, etc., are mounted on the Glass Rod.

Make two forks as shown in Figure 42 out of brass rod, three-sixteenths of an inch in diameter and solder brass balls at the ends. The forks are eleven inches long.

A number of small holes must be bored in the "prongs" and pins made by cutting ordinary dressmakers' pins in half and soldering them in place. These

pins, mounted on the forks, form the combs or collectors.

Bore a horizontal hole through each of the brass rods on the top of the glass rods and pass the shanks of the forks through and solder them in place.

One of the shanks may be provided with a discharge ball at the end as shown by *D B* in Figure 44. The other is provided with a hard rubber handle made from a piece of rod. Bore a three-eighths hole directly in the top of each brass ball to receive the quadrant rods forming the spark-gap.

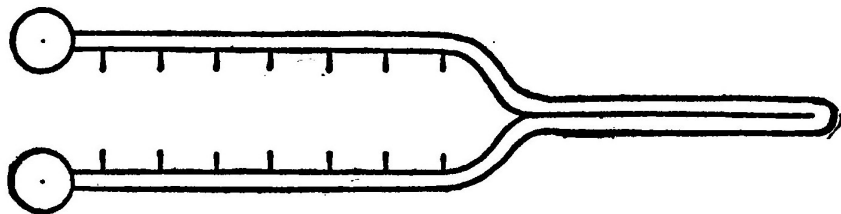

Fig. 42.—A Comb or Collector.

The quadrant rods extend over the top of the plates and are three-eighths of an inch in diameter. They are loose in the tops of the balls so that they may be moved about or removed entirely.

A small brass ball three-quarters of an inch in diameter should be soldered to the top of one of the quadrant rods and a similar ball two inches in diameter to the other.

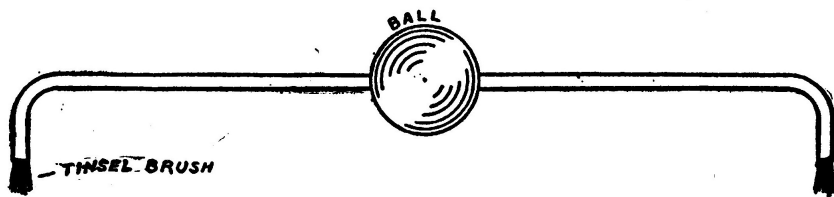

Fig. 43.—Showing how the Tinsel Brushes are arranged on the "Neutralizer" Rods.

Two large brass balls, two inches in diameter, are fitted over the ends of the axles, which project through the uprights. Bore a one-quarter-inch hole through each ball at right angles to the axle and slip a one-quarter-inch brass rod through and solder it fast.

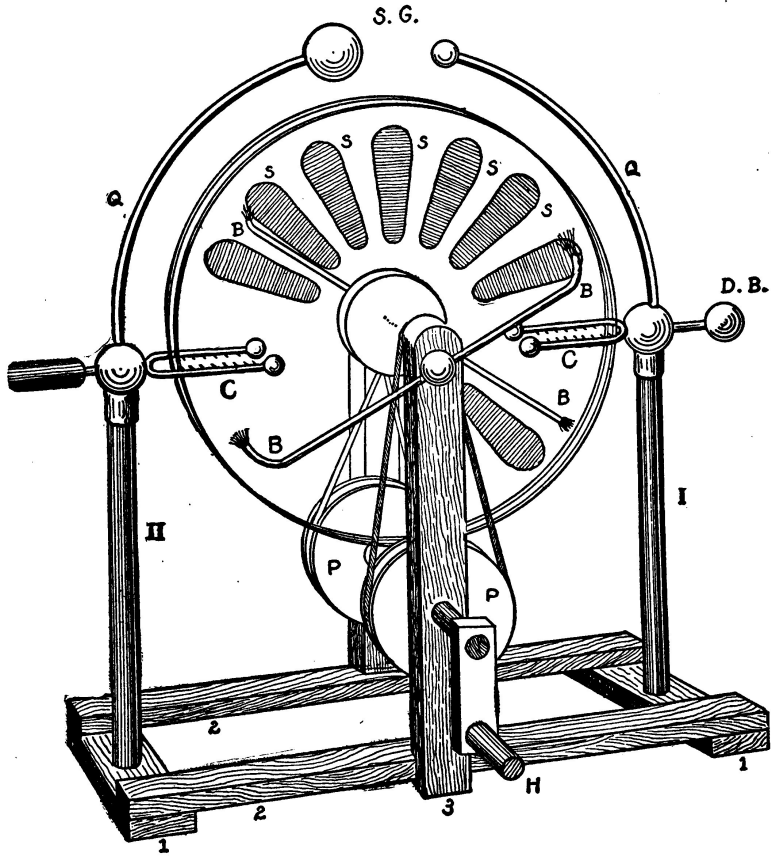

Fig. 44.—The Complete Wimshurst Electric Machine. B B B B, Brushes. C C, Combs. D B, Discharge Ball. I I, Glass Rods. H, Handle. Q Q, Quadrant Rods. S S S S S, Sectors. S G, Spark-Gap. P P, Driving-Wheels. For the sake of clearness, several of the sectors are not shown.

The ends of the rods should be tipped with a bunch of tinsel or fine copper wires and be curved so that the brushes so formed will just touch the sectors on the disks when the latter are revolved.

These are the neutralizers and are arranged in the approximate positions shown in Figure 44.

The driving-wheels are connected to the bosses by means of small round leather belts. The belt at the rear of the machine is crossed in order to make the plates revolve in opposite directions.

If the machine has been properly built it is now ready for operation. It may be necessary to charge the machine the first time that it is used by touching several of the sectors with the charged cover of an electrophorus. Then if the handle is turned the accumulated electricity should discharge across the spark-gap at the top of the machine in the form of bright blue sparks.

Experiments with an Electric Machine

Many interesting experiments can be performed with an electric machine. The number is almost unlimited. A few of the most instructive ones are described below. Others can be found in almost any text book on physics.

The **Leyden jar** consists of a glass jar coated with tinfoil part way up on both the outside and inside. Through the wooden stopper passes a brass rod or a heavy copper wire which connects with the inner coating of tinfoil by means of a small brass chain. The upper and outside end of the rod usually terminates in a brass ball or knob.

It is a very simple matter to make a good Leyden jar.

The jar must be thoroughly cleaned and dried before coating. The inside is then given a thorough brushing over with shellac or varnish. Before it is dry, carefully insert the tin-foil and press it smoothly against the glass. The outside of the jar is treated and coated in the same manner. The inside and outside of the bottom are also coated by cutting the tinfoil in circular pieces and shellacking them on.

In order to charge the Leyden jar, grasp it in the hand near the bottom and hold the knob against the prime conductor while turning the handle of the machine.

Igniting gunpowder. Bore a hole one-half inch in diameter and one inch deep in a block of hardwood. Pass two small brass wires through holes in the sides, letting the ends of the wires be about one-eighth of an inch apart. Pour a little gunpowder in loosely over the wires. Tie a piece of thoroughly moistened cotton twine, three inches long, to one of the wires and attach it to the outside coating of a charged Leyden jar.

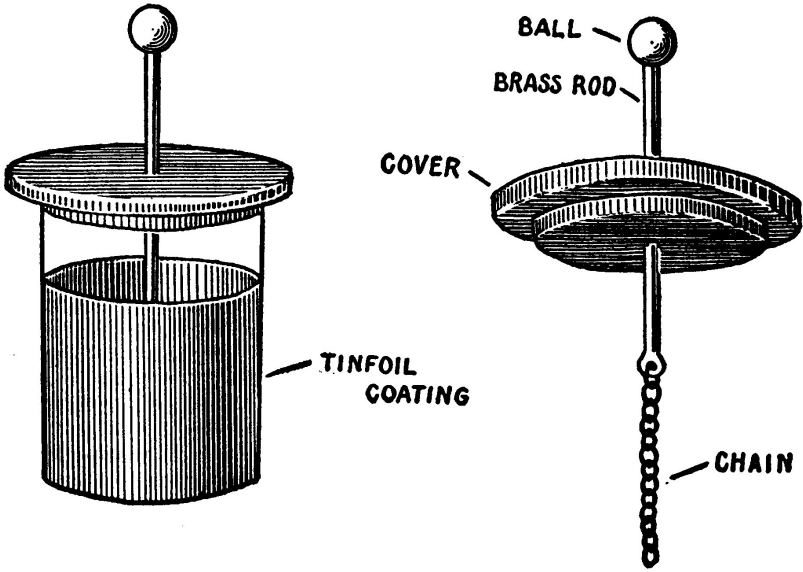

Fig. 45.—The Leyden Jar.

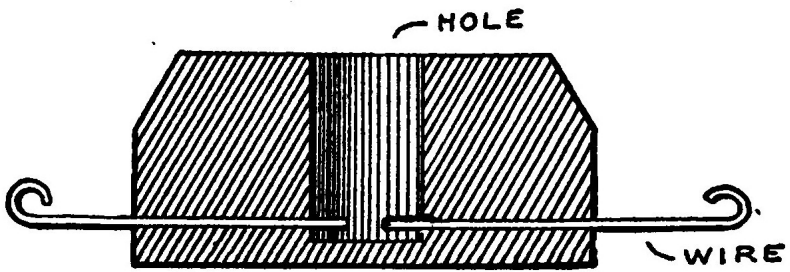

Fig. 46.—A Wooden Mortar for Igniting Gunpowder.

Connect the knob of the jar to the other wire. The gunpowder will immediately explode. Keep the face and hands away from the gunpowder when performing this experiment.

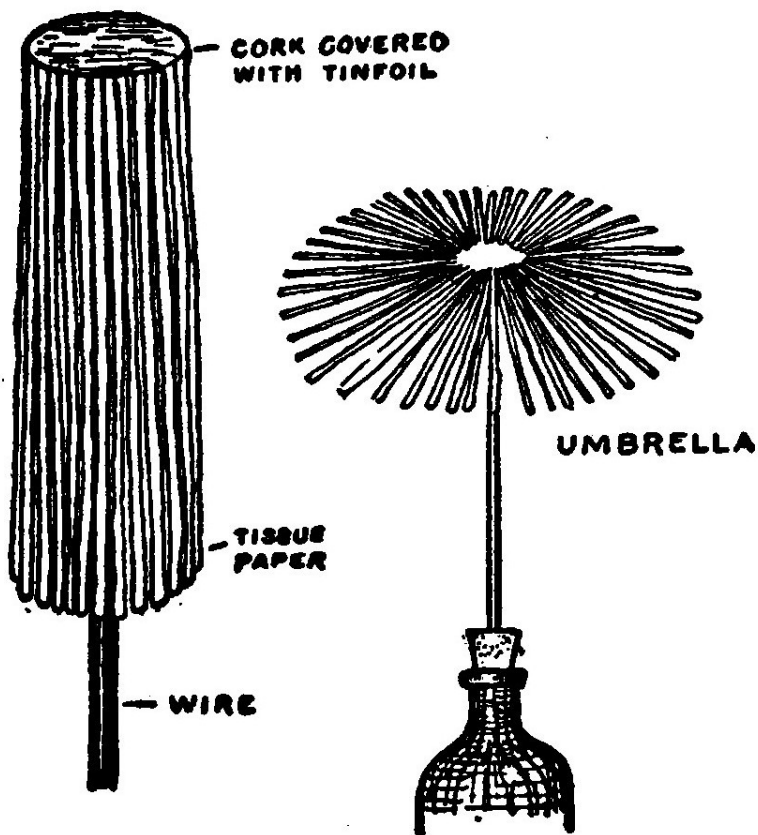

Fig. 47.—An Electric Umbrella.

Electric Umbrella. The repulsion of similarly electrified bodies which was illustrated by the action of the pith ball electroscope may be better illustrated by pasting some narrow streamers of tissue paper about one-eighth of an inch wide and four inches long to a small cork covered with tinfoil. The cork is mounted

on the upper end of a stiff copper wire supported in a bottle. When the wire is connected to the prime conductor and the machine set in motion, the strips will spread out like an umbrella.

Lightning Board. A pane of glass is thoroughly cleaned and then given a coat of shellac or varnish. Before the varnish is dry, press on a piece of tinfoil large enough to cover one side of the glass and rub it down smoothly.

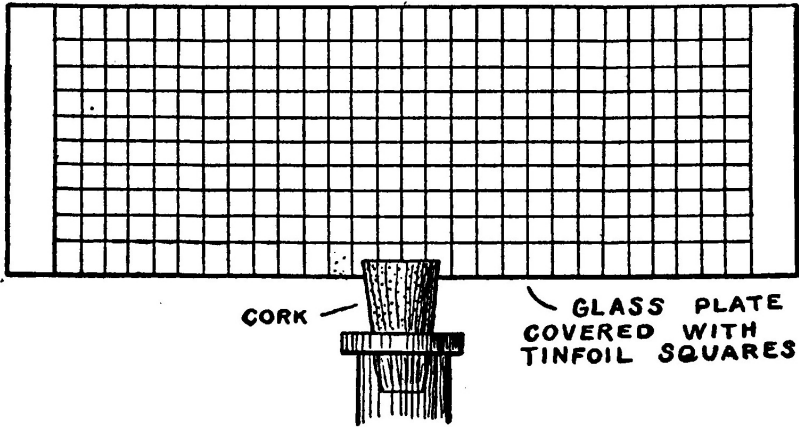

Fig. 48.—A Lightning Board.

After the shellac or varnish is dry, cut the tinfoil up into innumerable little squares with a sharp knife and ruler, leaving two solid strips of tinfoil at the ends of the glass pane.

The pane is mounted by cementing it in a slot in the cork of a bottle. Connect one of the tinfoil strips to the prime conductor and the other to the earth or the body. When the machine is turned, innumerable little sparks will pass between the tinfoil squares and give an appearance very similar to that of lightning.

The Electrical Dance. A number of little balls of cork or pith are enclosed in a cylinder of glass about two and one-half or three inches high formed by cutting off the top of a lamp chimney. The top and bottom of the cylinder are closed by two circular pieces of sheet brass or copper. The top disk is connected to the prime conductor while the bottom one is connected to the rubber. When the machine is set in motion, the little balls will dance up and down. Bits of feather or paper cut to represent figures of men and women may be used as well as pith or cork balls.

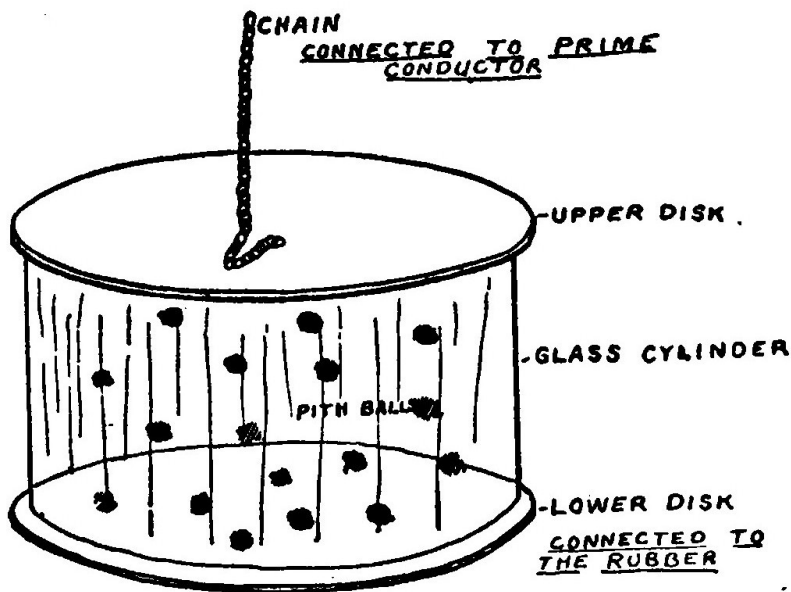

Fig. 49.—An Electric Dance.

The Electric Whirl. The whirl consists of an S shaped piece of brass wire, pointed at both ends and supported on a needle by a little conical depression made in the center with a punch.

The needle is stuck in a cork in the top of a bottle and connected with the prime conductor of the electric machine. When the latter is set in motion, the whirl will commence to revolve at a high rate of speed.

Lichtenberg's Figures can be produced by charging a Leyden jar by connecting the knob or inside coating with the prime conductor and holding the outside coating in the hand.

Then trace a small circle on the electrophorus bed with the knob.

Charge a second Leyden jar by connecting the outside coating with the prime conductor.

The inside coating should be connected to the rubber by means of a wire fastened to the knob. The same result may be obtained by connecting the outside

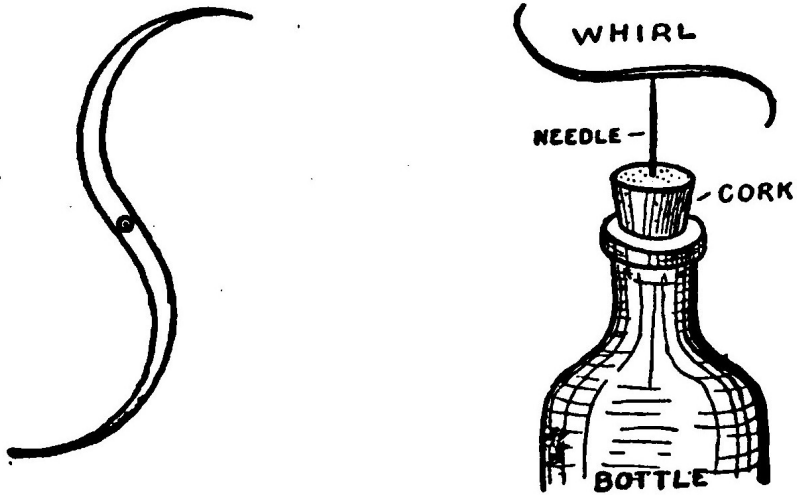

Fig. 50.—An Electric Whirl.

coating with the prime conductor and touching the knob with the hand.

Then trace a cross on the electrophorus bed with the knob, making the cross inside of the circle.

Shake a mixture of red lead and sulphur through a muslin bag from a height of several inches over the electrophorus.

The red lead will accumulate around the cross and the sulphur around the circle.

CHAPTER IV CELLS AND BATTERIES

In order that the young experimenter may obtain electricity for driving his various electrical devices it is necessary to resort to batteries, a small dynamo, or the house-lighting current.

All houses are not supplied with electric current. Furthermore, many boys have no source of power from which to drive a small dynamo. Batteries must therefore be resorted to in the majority of cases.

A number of different cells and batteries are described in this chapter. All of them are practical, but after buying zinc, chemicals, etc., for any length of time,

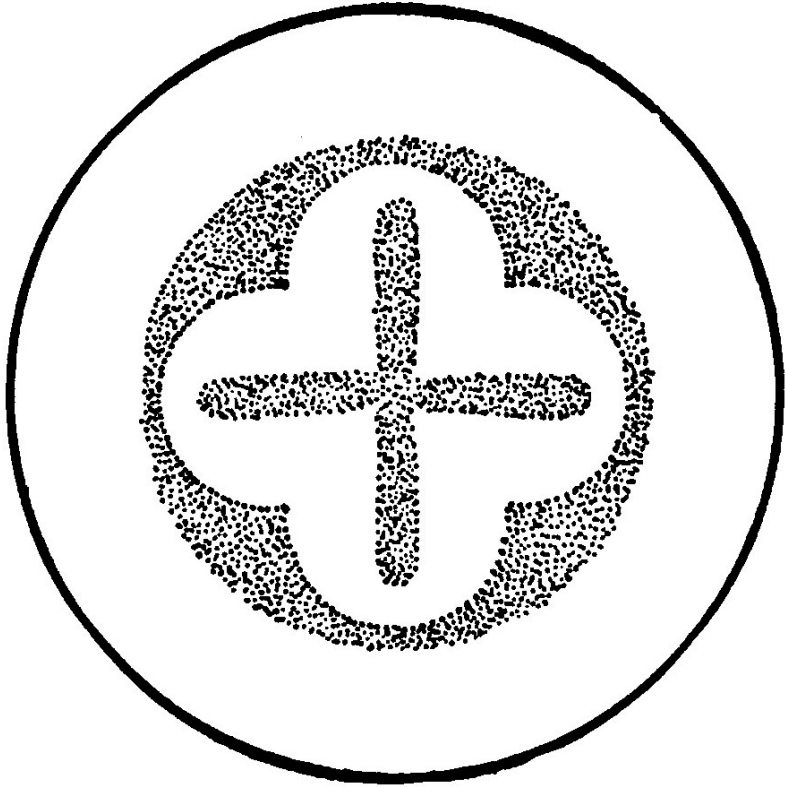

Fig. 51.—Lichtenberg's Figures.

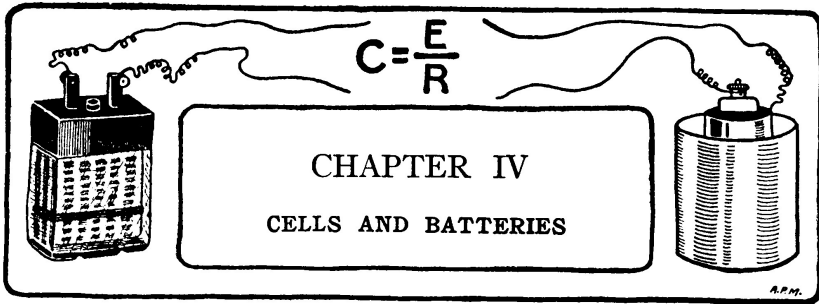

figure out what your batteries *cost* you to make. The real value is not their cost in dollars and cents but in what you have *learned* in making them. If you have a continuous use for electrical current for running *small* electrical devices it is cheaper to buy dry cells, or what is better, a *storage battery*, and have it *recharged* when necessary.

Build your own batteries first. Then after you have learned how they are made and something about their proper care buy them from some reliable electrical house.

Batteries are always interesting to the average experimenter, and when properly made are one of the most useful pieces of apparatus around the home, laboratory, or shop that it is possible to construct. Many hundreds of thousands of experiments have been carried out by capable men in an effort to discover or devise a perfect battery, and the list of such cells is very great.

Only the most common forms, which are simple and inexpensive to construct but will at the same time render fair service, have been chosen for description.

Cells are usually considered *one* element or jar of a battery. A *cell* means only one, while a *battery* is a *group* of cells. It is not a proper use of the word to say "battery" when only *one* cell is implied. This is a very common error.

The **Voltaic cell** is called after its inventor, Volta, a professor in the University of Pavia, and dates back to about the year 1786.

A simple voltaic cell is easily made by placing some water mixed with a little sulphuric acid in a glass tumbler and immersing therein two clean strips, one of zinc and the other of copper. The strips must be kept separate from each other. The sulphuric acid must be diluted by mixing it with about ten times its volume of water. In mixing acid with water always remember never to pour water into acid but to perform the operation the other way and pour the acid

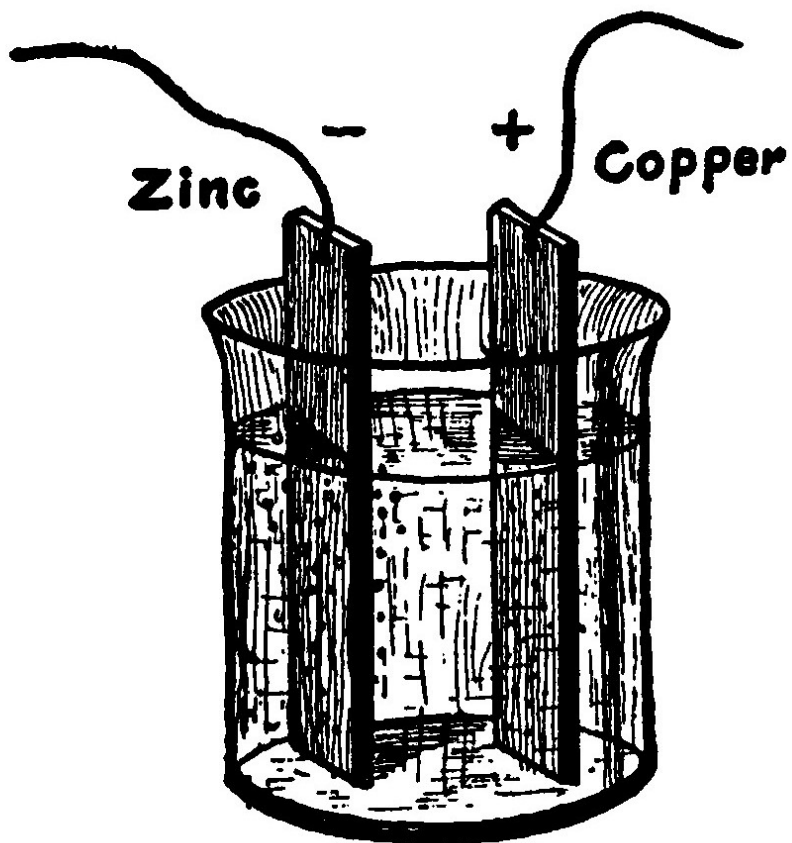

Fig. 52.—The Voltaic Cell.

into the water. A copper wire is fastened with a screw or by soldering to the top of each of the strips, and care must be exercised to keep the wires apart.

As has been said, the zinc and copper must never be allowed to touch each other in the solution, but must be kept at opposite sides of the jar.

The sulphuric acid solution attacks the zinc, causing it slowly to waste away and disappear. This action is called *oxidation*, and in reality is a very slow process of burning. The consumption of the zinc furnishes the electric energy, which in the case of this cell will be found to be sufficient to ring a bell or buzzer, or run a very small toy motor.

As soon as the plates are immersed in the acid solution, bubbles will begin to rise from the zinc. These bubbles contain a gas called hydrogen and they indicate that a chemical action is taking place. The zinc is being dissolved and the *hydrogen* gas is being set free from the acid. It will be noticed that no bubbles arise from the copper plate and that there is little if any chemical action there. In other words, it seems that the chemical action at one plate is stronger than that at the other.

A cell might be likened to a furnace in which the zinc is the fuel which is burned to furnish the energy. We know that if the zinc is burned or oxidized in the open air it will give out energy in the form of *heat*. When it is burned or oxidized slowly in acid in the presence of another metal it gives out its energy in the form of *electricity*. The acid might be likened to the fire, and the copper to a hand which dips into the cell to pick up the current and takes no part chemically.

If a wire is connected to each of the plates and the free ends of the wires touched to the tip of the tongue it will produce a peculiar salty taste in the mouth indicating the presence of a current of electricity.

If the wires are connected to an electric bell, the bell will ring, or, instead, the current may be used to run a small motor. If the cell is made of two zinc plates or two copper plates, the bell will not ring, because no electricity will be produced. In order to produce a current, the electrodes must be made of two different materials upon which the acid acts differently. Current may be obtained from a cell made with a zinc and carbon plate or from one with zinc and iron.

Therefore, in order to make a battery it is necessary to have a metal which may be consumed, a chemical to consume or oxidize it, and an inactive element which is merely present to collect the electricity.

When the wires connected to the two plates are joined together, a current of electricity will flow from the copper plate through the wire to the zinc. The copper is known as the *positive* pole and the zinc as the *negative*.

A simple voltaic cell may be easily made by cutting out a strip of zinc and a strip of copper, each 3 1/2 inches long, and one inch wide. A small hole bored through the upper end of the strips will permit them to be mounted on a wooden

strip with a screw as shown in Figure 53. The connecting wires are placed under the heads of the screws. Care should be exercised to arrange the screws used for mounting the electrodes to the wooden strip so that they do not come exactly opposite, and there is no danger of the points touching and forming a short circuit.

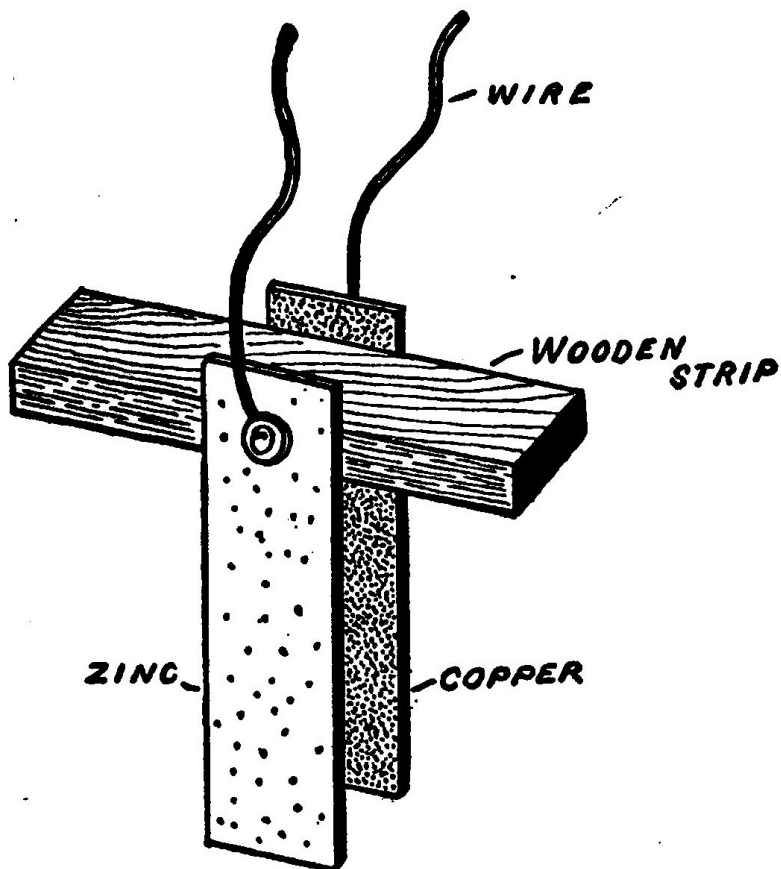

Fig. 53.—The Elements of Simple Voltaic Cell.

An ordinary tumbler or jelly glass will make a good battery jar. The exciting liquid should be composed of

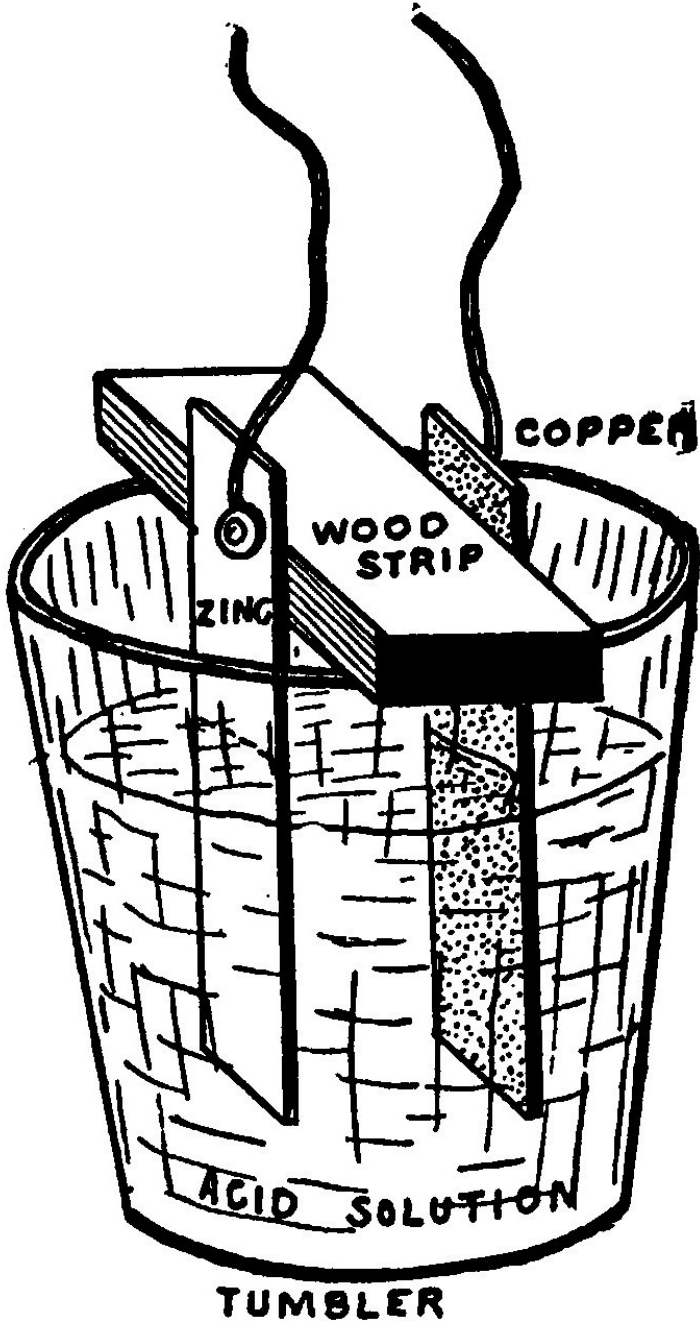

Fig. 54. A Home Made Voltaic Cell

One part of sulphuric acid
Ten parts of water

One of the disadvantages of the voltaic cell is that it becomes *polarized*, that is, small bubbles of hydrogen which are liberated by the chemical action collect on the copper plate and cause the strength of the battery to fall off rapidly.

There are a great number of *elements*, as the zinc and copper are called, and an even greater number of different solutions or *excitants* which can be employed in place of sulphuric acid to make a cell, forming an almost endless number of possible combinations.

Leclanche Cell. One of the most common forms of cell employed for bell-ringing, telephones, etc., is called the Leclanche cell, after its inventor, and consists of two elements, one of zinc and the other of carbon, immersed in a solution of *sal ammoniac* or *ammonium chloride*. This cell has an E. M. F. of 1.4 volts, which is about half as much again as the voltaic cell.

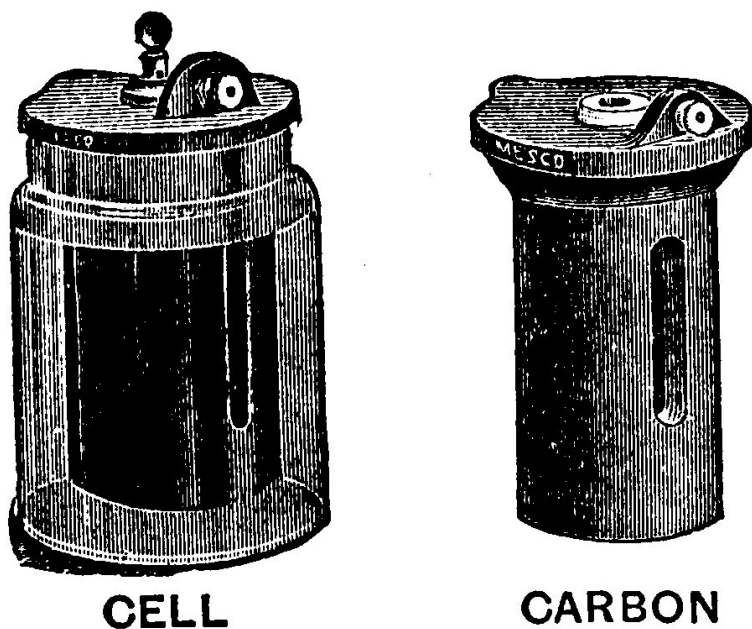

Fig. 55.—Carbon-Cylinder Cell, and Cylinder.

The most common form of Leclanche cell is illustrated in Figure 55. This type is usually known as a "carbon cylinder" cell because the positive element is a hollow carbon cylinder. The zinc is in the form of a rod passing through a porcelain bushing set in the center of the carbon cylinder. A battery of such cells can only be used successfully for open circuit work. The "open circuit" is used for bells, burglar alarms, telephone circuits, etc., or wherever the circuit is such that it is "open" most of the time and current is only drawn occasionally and then only for short periods.

If the current is drawn for any appreciable length of time hydrogen gas will collect on the carbon cylinder and the cell will become *polarized*. When polarized it will not deliver much current.

Many methods have been devised for overcoming this difficulty, but even the best of them are only partially successful.

The usual method is to employ a chemical *depolarizing* agent. Figure 56 shows a Leclanche cell provided with a *depolarizer*.

The carbon is in the form of a plate placed in a *porous cup* made of earthenware and filled with *manganese dioxide*.

Chemists class *manganese dioxide* as an *oxidizing* agent, which means that it will furnish oxygen with comparative ease. Oxygen and hydrogen have a strong *chemical affinity* or attraction for each other.

If the carbon plate is packed in manganese dioxide any hydrogen which tends to collect on the carbon and polarize the cell is immediately *seized* by the oxygen of the manganese dioxide and united with it to form water.

This form of Leclanche cell is called the disk type. It is capable of delivering a stronger current for a longer period of time than the carbon cylinder battery. The zinc is usually made in the form of a cylinder, and fits around the outside of the porous cup.

Dry Cells are used extensively nowadays for all open circuit work on account of their convenience and high efficiency.

The dry cell is not, as its name implies, "dry," but the exciting agent or electrolyte, instead of being a liquid, is a wet paste which cannot spill or run over. The top of the cell is poured full of molten pitch, thus effectively sealing it and making it possible to place the cell in any position.

Dry cells can be purchased from almost any electrical house or garage for twenty-five cents each. It will therefore hardly pay the young experimenter to make his own *dry cells*. For the sake of those who may care to do so, however, directions for building a simple but efficient dry cell of the type used for doorbells and ignition work, will be found below.

The principle of a dry cell is the same as that of a Leclanche cell of the disk type. The exciting solution is *ammonium chloride*, the electrodes or elements

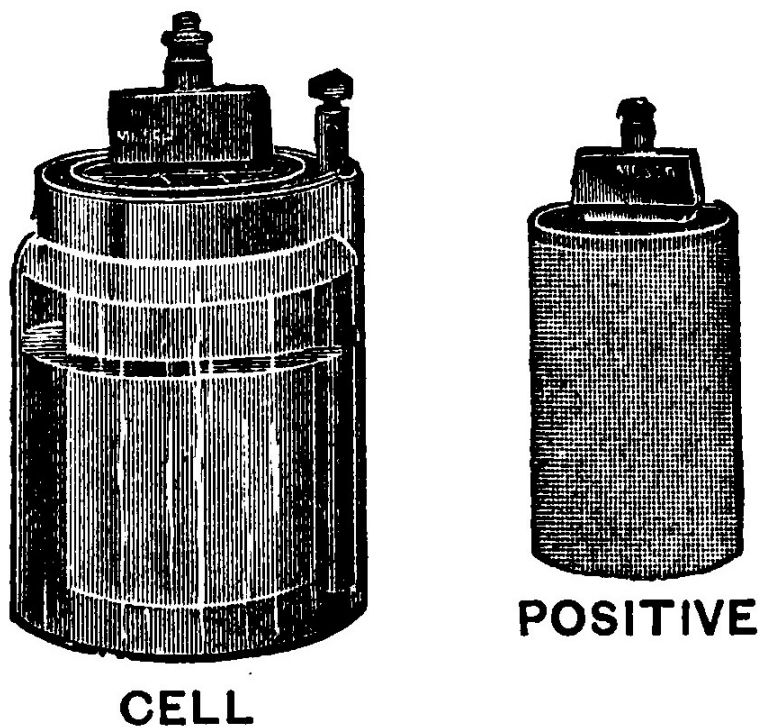

Fig. 56.—A Leclanche Cell, showing the Porous Cup.

are zinc and carbon, and the carbon is surrounded by manganese dioxide as a depolarizing agent.

Obtain some sheet zinc from a plumbing shop or a hardware store and cut out as many rectangles, 8 x 6 inches, as it is desired to make cells. Also cut out an equal number of circles 2 3/8 inches in diameter.

Roll the sheets up into cylinders 2 3/8 inches in diameter inside and 6 inches long. The edges are lapped and soldered. Fit one of the round circles in one end of each of the cylinders and solder them securely into place, taking care to close up all seams or joints which might permit the electrolyte to escape or evaporate.

Secure some old carbon rods or plates by breaking open some old dry cells. The carbons will be in the form of a flat plate, a round rod, or a star-shaped corrugated rod, depending upon the manufacture of the cell. Any of these types



Guaranteed for all
Opencircuit work

RED
DRY BATTERY
SEAY

TRADE MARK

For Ignition.
AND ALL OTHER WORK REQUIRING
High Amperage

of carbons will serve the purpose well, provided that they are fitted with a thumb-screw or a small bolt and nut at the top so as to make wire connections with the carbon.

Make a wooden plunger of the same shape as the carbon which you may select, but make it slightly larger. Smooth it with sandpaper and give it a coat of shellac to prevent it from absorbing moisture.

This wooden plunger is temporarily inserted in the center of one of the zinc cups and supported so that it will be about one-half inch above the bottom.

The electrolyte is prepared by mixing together the following ingredients in the proportions shown:

Sal Ammoniac. 1 part
Zinc Chloride. 1 part
Plaster of Paris. 3 parts
Flour. 3/4 part
Water. 2 parts

The above paste is then firmly packed into the zinc shell around the wooden plunger, leaving a space of about 3/4 of an inch at the top. The paste can be poured in very readily when first mixed but sets and hardens after standing a short while.

After it has set, withdraw the wooden plunger, thus leaving a space inside of the dry cell a little larger than the carbon. The carbon is now inserted in this hole and the surrounding space is filled with a mixture composed of:

Sal Ammoniac. 1 part
Zinc Chloride. 1 part
Manganese Dioxide. 1 part
Granulated Carbon. 1 part
Flour. 1 part
Plaster of Paris. 3 parts
Water. 2 parts

The granular carbon may be had by crushing up some old battery carbons. The parts given in both of the above formulas are proportioned so that they may be measured by bulk and not by weight. An old teaspoon or a small cup will make a good measure.

Each one of the zinc shells should be filled in this manner. After they have all been filled, clean off the top edge of the zinc and pour the remaining space in the cell full of molten tar or pitch so as to seal it over.

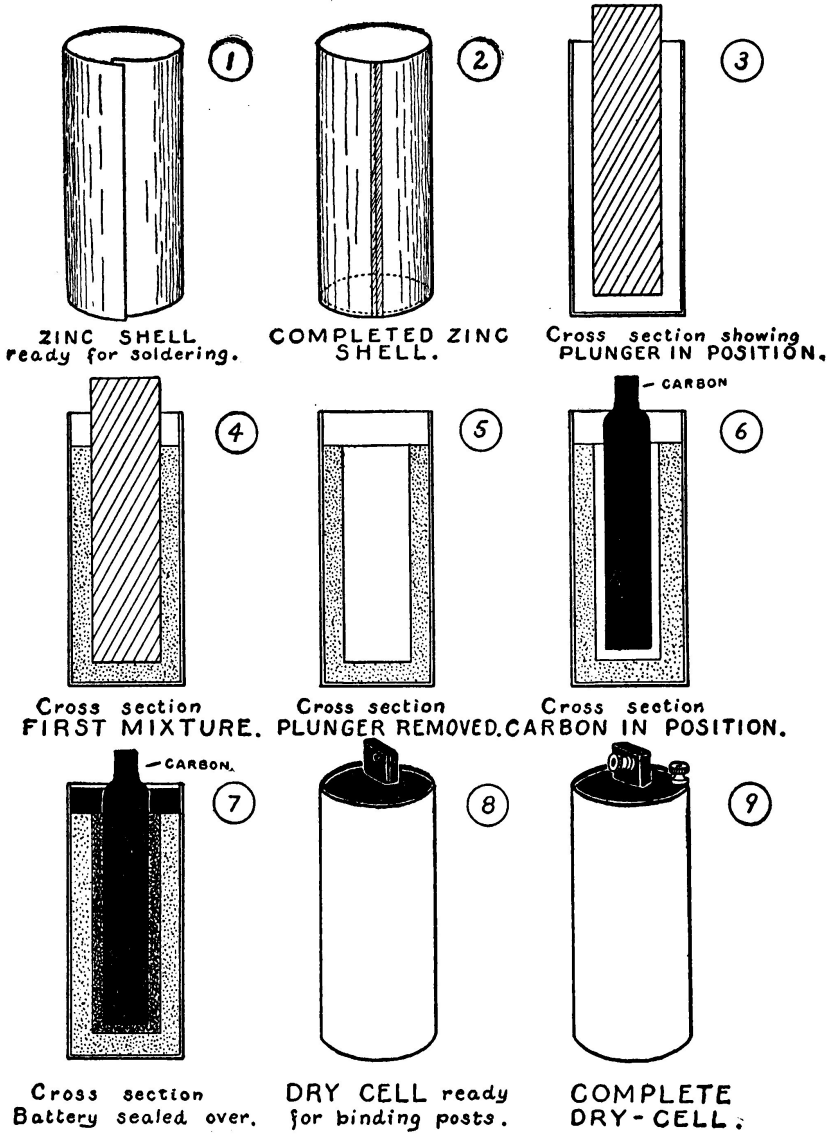

Fig. 58.—The Different Operations involved in Making a Dry Cell.

Solder a small binding-post to the top edge of the zinc to facilitate connection. Then wrap the cells in several thicknesses of heavy paper to prevent them from short circuiting, and they are ready for use.

A small hole bored through the sealing material after it is dry will provide a vent for the escape of gases.

Recharging dry cells is a subject that interests most experimenters.

Dry cells very often become useless before the zinc shell is used up or the chemicals are exhausted, due to the fact that the water inside of the cell dries up and the resistance therefore becomes so great that it is practically impossible for the current to pass.

The life of such cells may be partially renewed by drilling several holes in the cell and permitting it to soak in a strong solution of sal ammoniac until some of the liquid is absorbed. The holes should then be plugged up with some sealing wax in order to prevent evaporation.

An old dry cell may be easily turned into a "wet" cell by drilling the zinc full of holes and then setting it in a jar containing a sal ammoniac solution. The battery should be allowed to remain in the solution.

Wet batteries are very much easier to make than dry batteries and are capable of delivering more current.

They have the disadvantage, however, of wasting away more rapidly, when not in service, than dry cells.

The Leclanche cell is the type generally first attempted by most experimenters.

Carbon plates for making such a battery are most easily and cheaply obtained from old dry cells. About the only way that a dry cell can be broken open is with a cold-chisel and a hammer. Care must be taken, however, in order not to break the carbon.

Ordinary jelly-glasses make good jars for small cells. Fruit-jars may be used for larger batteries by cutting the tops off so that the opening is larger. The carbon plate contained in a dry cell is usually too long for a jar of this sort and must be broken off before it can be used. The lower end is the one which should be broken because the top carries a binding-post, with which connections can be made. A small hole is bored in the carbon rod at a distance from the bottom equal to the height of the jar which is to be used.

Considerable care must be used in boring carbon because it is very brittle and easily cracks. Only very light pressure should be used on the drill. The carbon is fastened to a strip of wood, about an inch and one-quarter wide, one-half an inch thick, and a little longer than the top of the glass jar is wide.

A piece of heavy sheet zinc is fastened on the other side opposite the carbon, with a screw. It is a good idea to paint the screws and the surrounding

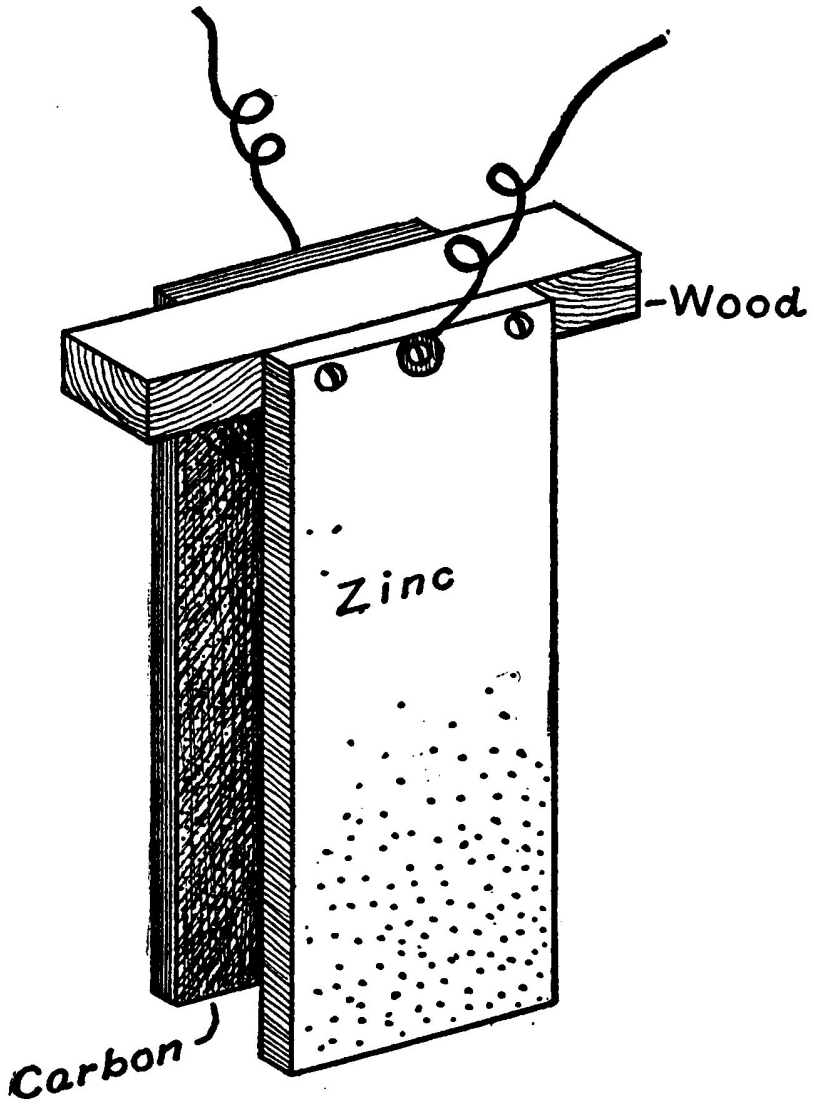

Fig. 59.—A Zinc-Carbon Element, made from Heavy plates.

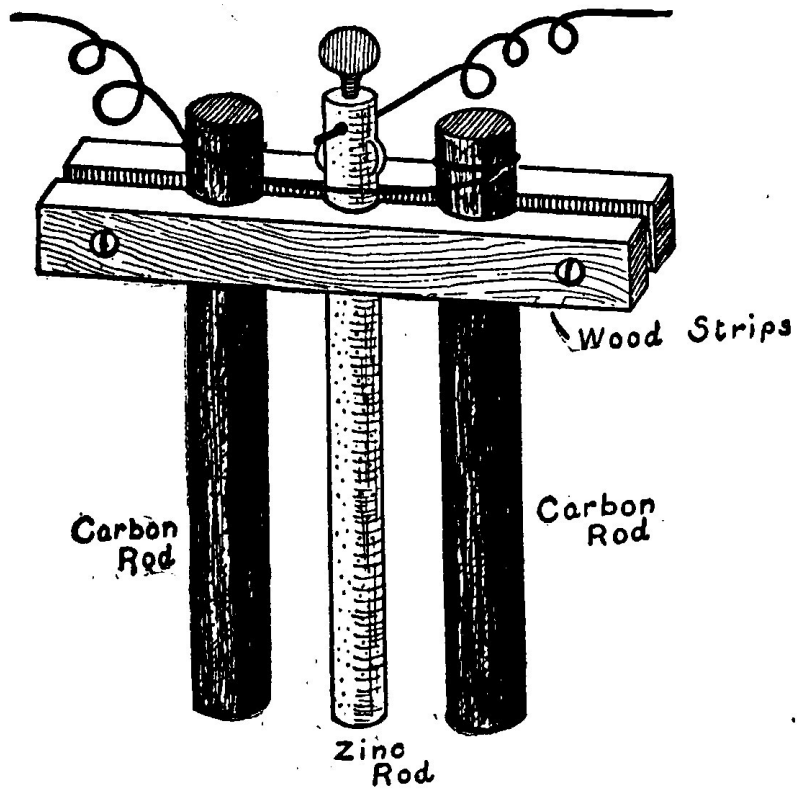

Fig. 60.—A Method of making a Cell Element from Carbon Rods.

portions of both the zinc and the carbon with hot paraffin wax so that the solution will not "creep" and attack the screws. It is also a good plan first to soak the wooden strip in some hot paraffin until it is thoroughly impregnated.

Ammonium chloride, or, as it is more commonly called, sal ammoniac, should be added to a jar of water until it will dissolve no more. The zinc and carbon elements may then be placed in the solution.

One of the great disadvantages of the voltaic cell is that the zinc is attacked by the acid when the battery is not in use and cannot be allowed to remain in the solution without quickly wasting away. This is true in the case of the Leclanche cell only to a very small extent. The voltaic cell is more powerful than the Leclanche cell, but the elements must be carefully lifted out and rinsed with water every time that you are through using the cell. By using several carbon plates instead of one, the cell may be made more powerful. The illustrations show several ways of accomplishing this. The simplest method is to place a carbon plate on each side of the wooden strip and use a zinc in the form of a rod which passes through a hole between the two. Care must always be used to keep any screws which are used to hold the carbons or zincs in position in the cells from touching each other.

In Figure 62 an arrangement of using four carbons is shown. The drawing is self-explanatory. In any of the cells using more than one carbon element, the carbons should all be connected.

In discussing the voltaic cell we mentioned the fact that it becomes polarized, and explained this phenomenon as being caused by hydrogen bubbles collecting on the copper or positive pole. The same thing happens in the case of carbon or any other material which is used as a positive.

Polarization is the "bugbear" of batteries. It can be eliminated to a certain extent, however, by the use of a "depolarizer" *placed in the solution*. There are several such substances, the most common being *sodium bichromate* and *potassium bichromate*. These are used in battery preparations on the market called "Electric Sand," "Electropeian Fluid," etc.

When one of these is added to a sulphuric acid solution, using zinc and carbon as the battery elements, it forms a very powerful cell, having E. M. F. of two volts.

A battery solution of this kind may be prepared by adding four ounces of bichromate of potash to a solution composed of four ounces of sulphuric acid mixed with sixteen ounces of water. The battery will give a more powerful current for a longer time when this solution is used instead of the plain sulphuric acid and water or sal ammoniac.

It might be well at this time to caution the experimenter against the careless handling of sulphuric acid. It is not dangerous if handled properly, but if spilled

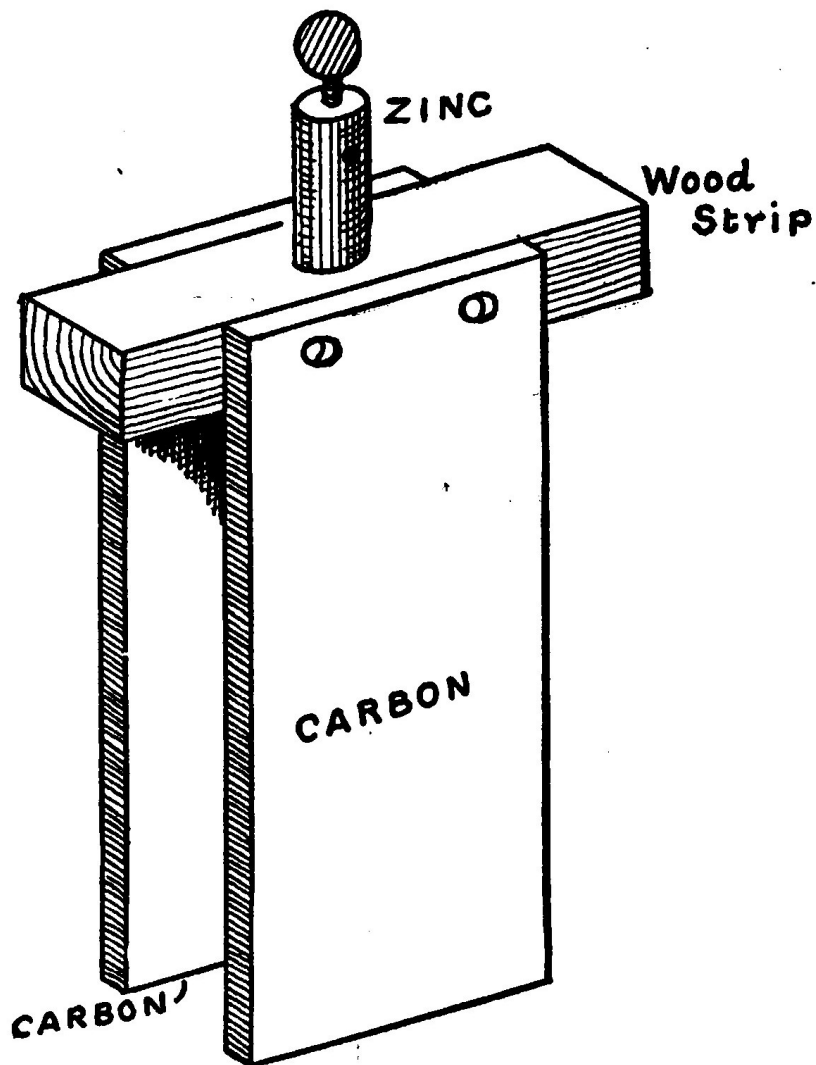

Fig. 61. An Element made from two Carbon Plates and a Zinc Rod.

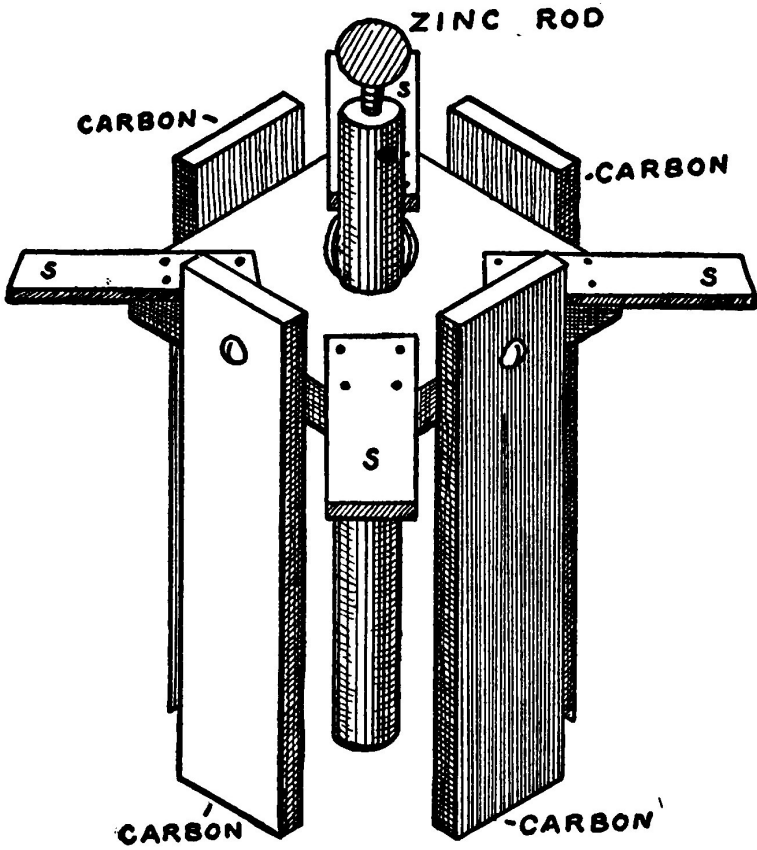

Fig. 62. A Method of Mounting four Carbon Plates.

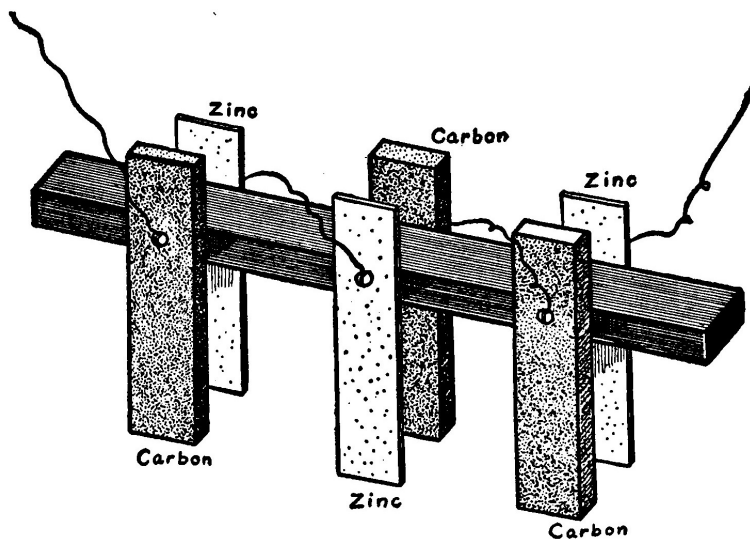

Fig. 63.—A Battery Element arranged for three Cells.

or spattered around carelessly it is capable of doing considerable damage to most things with which it comes in contact. Do not attempt to use it in any place but a shop or cellar. The smallest drop coming in contact with any organic matter such as woodwork, clothing, carpets, etc., will not only discolor any of the latter, but eat a hole in it. The best thing to use to counteract the effects of the acid which has been spilled or spattered is water in sufficient quantity to drench things and dilute the acid enough to render it harmless. A little strong ammonia will neutralize the acid and sometimes restore the color to clothing which has been burned by acid.

All acid batteries of this sort have the one objection that it is impossible to leave the elements in the solution without wasting the zinc. The usual way to arrange the battery cells so that the elements may be removed from the solution most easily is to fasten the elements to a chain or cord passing over a windlass fitted with a crank so that when the crank is turned the elements may be raised or lowered as desired.

A "plunge battery" of this sort is illustrated in Figure 64. The construction is so plainly shown by the drawing that it is hardly necessary to enter into the details. The crank is arranged with a dowel-pin which passes through into a hole

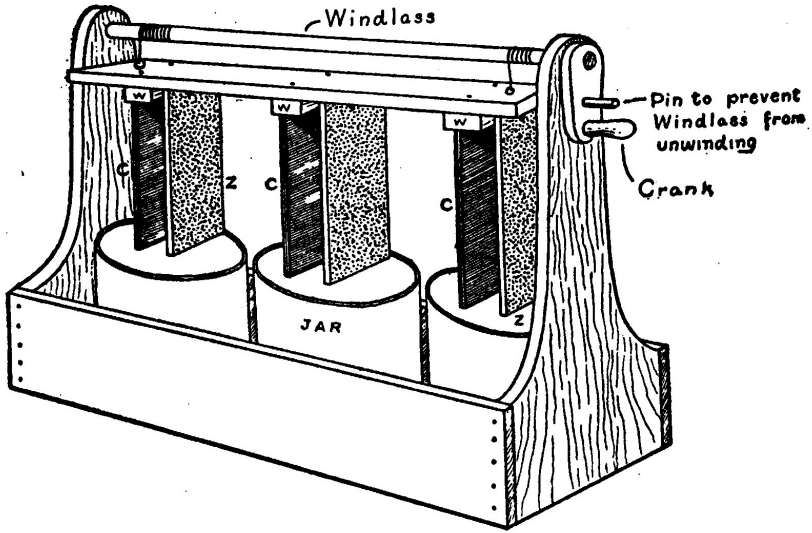

Fig. 64.—A Plunge Battery, with Windlass.

in the frame, so that when the elements are lifted out of the solution the pin may be inserted in the hole and the windlass prevented from unwinding.

A somewhat easier method of accomplishing the same result is that shown by Figure 65. In this, the elements are simply raised up out of the jars and laid across the two "arms" to drain.

The Edison-Lalande cell employs a block of pressed copper oxide as the positive element, while two zinc plates form the negative. The exciting liquid is a strong solution of caustic soda.

The copper oxide acts both as the positive element and as a depolarizer, for the oxygen of the oxide immediately combines with any hydrogen tending to form on the plate.

This type of cell has some advantages but also many disadvantages, chief among which is the fact that the E. M. F. is very low. It is used principally for railway signal work, slot-machines, etc.

A Tomato-Can Battery using caustic soda as the exciting liquid is a simple form of home-made battery whose only disadvantage is the low voltage that it delivers.

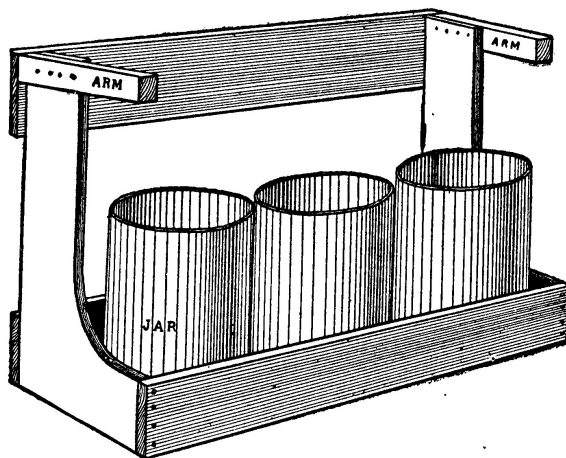

Fig. 65.—A Plunge Battery adapted to a Set of Elements, as shown in Figure 63. They may be lifted out and placed on the "Arms" to drain.

The cell is liable to polarization, but the large surface of its positive elements protects it to some extent.

The positive element and the outer vessel is a tomato can. Within it is a porous cup made out of blotting paper or unglazed earthenware such as a flower pot.

The space between the can and the porous cup is filled with fine scrap-iron such as borings and turnings. A zinc plate is placed in the porous cup.

The cell is filled with a ten-per-cent solution of caustic soda.

The following table gives the names, elements, fluids, voltage, etc., of the most useful batteries, all of which may be easily constructed by the experimenter.

Secondary or Storage Batteries

The storage battery is a very convenient means of taking energy at one time or place and using it at some other time or place.

Small storage batteries are used in automobiles to supply current for the headlights and spark-coils. Many automobiles are now equipped with "electric starters," consisting of a dynamo-motor and a storage battery. Throwing a switch will cause the current from the storage battery to drive the motor and "crank" the

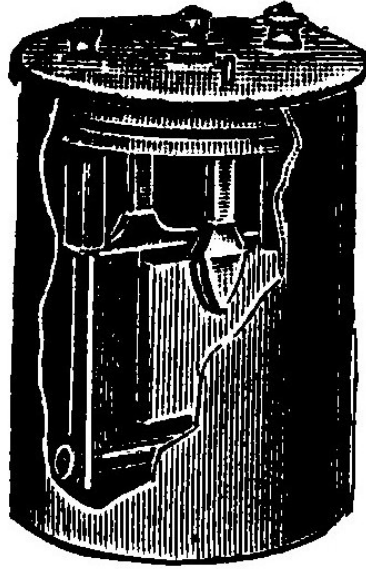

Fig. 66.—An Edison-Lalande Cell.

engine. After the engine is started, the motor acts as a dynamo and generates a current for recharging the storage battery.

Storage batteries are also used to drive electric vehicles and cars.

Many central lighting and power stations employ storage batteries to supply the extra current demanded during rush hours. In the middle of the day, when the "load" is light, the surplus current of the dynamos is used to recharge the storage batteries.

What is really effected in the storage battery is the electrical storage of *energy*, not the storage of electricity. Properly speaking, the energy is put into the form of chemical energy, and there is really *no more electricity in the cell* when it is charged than after it is discharged.

Storage batteries are made up of plates of lead (the electrodes) or an alloy of lead cast into a "grid" or framework.

The framework may be one of a large number of patterns, but usually consists of a set of bars crossing one another at right angles, leaving a space between.

The spaces are filled with a paste of *lead oxide*. They are then "formed" by

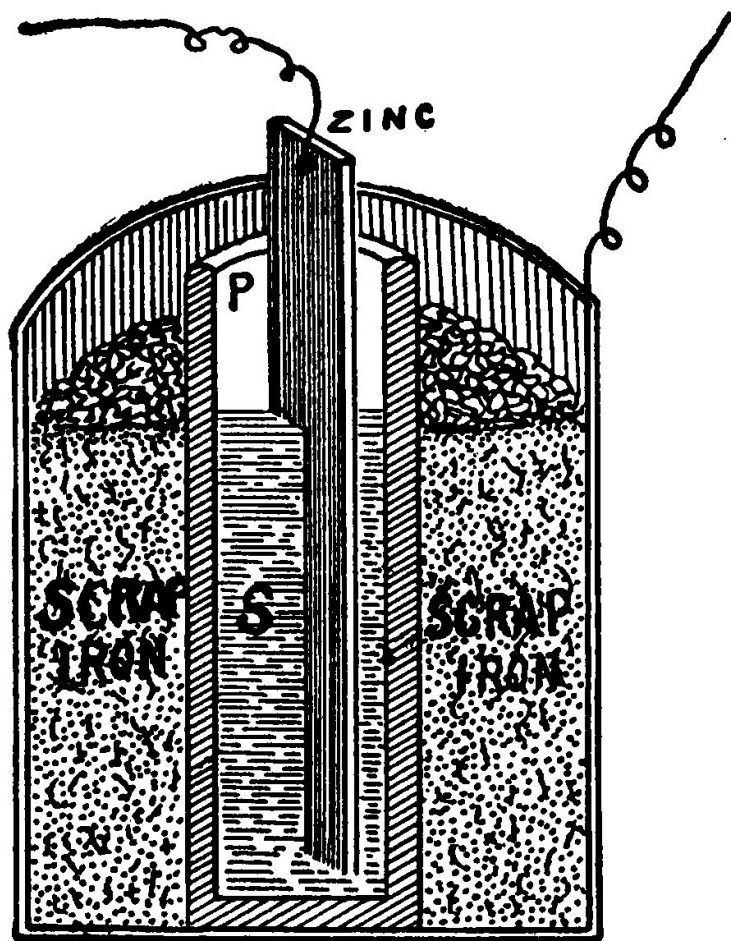

Fig. 67.—A Tomato-Can Cell; Sectional View.

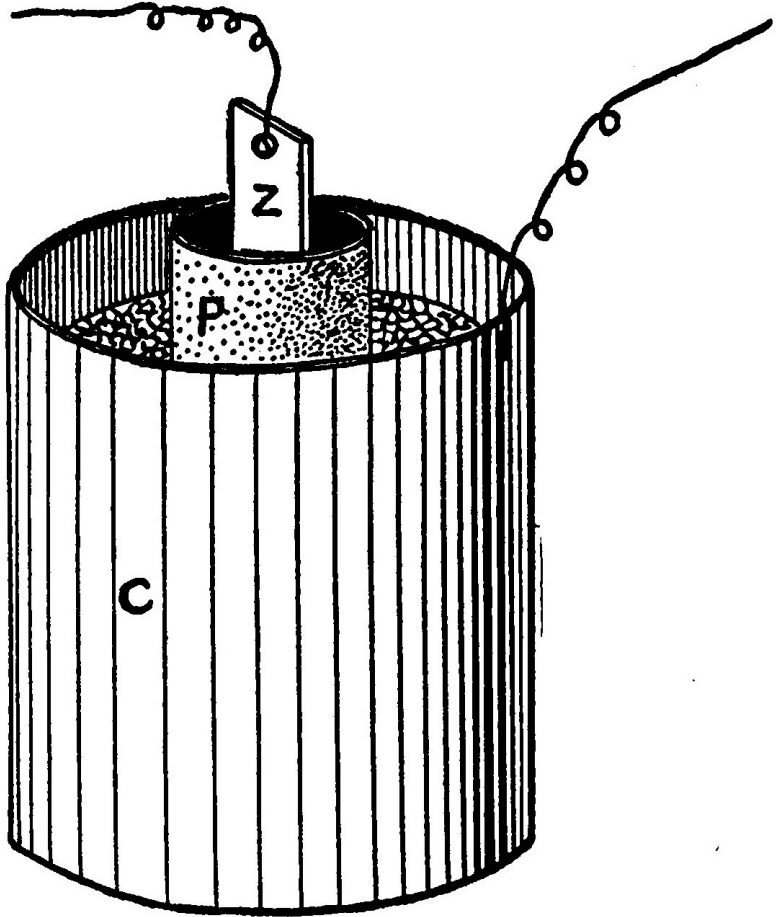

Fig. 68.—The Tomato-Can Cell Complete.

Name of Cell	Positive Element	Negative Element	Exciting Fluid	Depolarizing Fluid	E. M. F. in Volts	Remarks
Bunsen	Carbon	Zinc	Sulphuric acid, dilute	Nitric acid	1.734	The carbon and nitric acid are placed in a porous cup.
Bunsen	"	"	"	Chromic acid	1.734	The carbon and chromic acid are placed in a porous cup.
Chromic acid, single fluid	"	"	Sulphuric acid and chromic acid, dilute, mixed	None separate	2.2	
Daniell	Copper	"	Zinc sulphate solution	Copper sulphate solution	1.079	The zinc is placed above the copper and the solutions are separated by gravity forming the so-called "gravity cell."
Fuller	Carbon	"	Chloride of zinc solution	Bichromate of potash and hydrochloric acid	1.5	The carbon and depolarizer are placed on the <i>outside</i> of a porous cup.
Niaudet	"	"	Common salt solution	Chloride of lime	1.5	The carbon and chloride of lime are placed in a porous cup.
Poggen-dorf	"	"	Saturated solution of bichromate of potash and sulphuric acid	None separate	1.08	

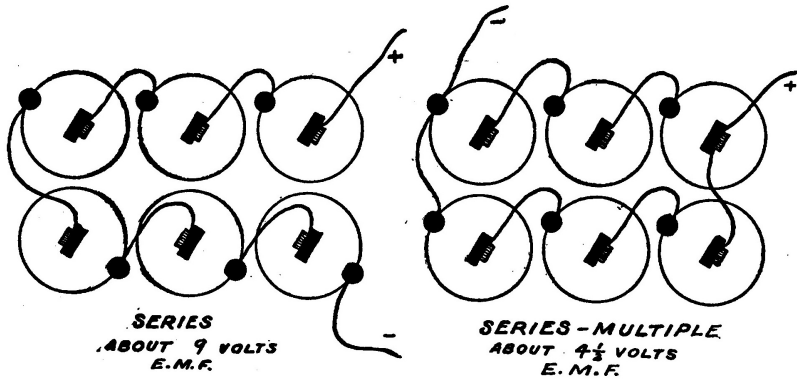

Fig. 69.—Two Methods of Connecting Cells so as to obtain Different Voltage and Amperage Values.

placing in a tank of acid solution and connected to a source of electric current.

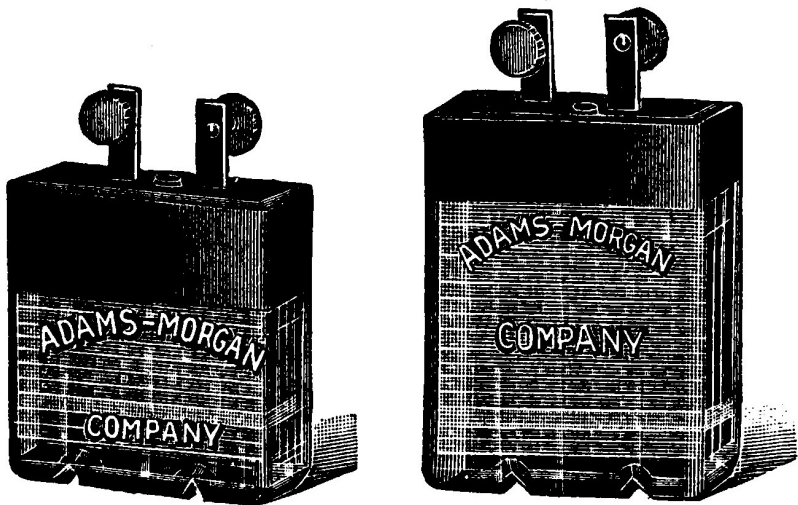

Fig. 70.—Small Storage Cells.

The plate connected to the positive wire gradually turns dark-brown in color, due to the changes in the paste, which gradually turns into *lead peroxide*. The paste in the negative plate becomes gray in color and changes into a form of metallic lead called *spongy lead*.

The positive and negative plates are placed in a bundle after the forming process has been completed. They are kept apart by strips of wood or rubber called separators.

The negative plates of one cell are all connected in parallel at one end of the cell. The positive plates are connected at the other end. The liquid surrounding the plates is diluted sulphuric acid.

When the battery has been exhausted, it is charged by connecting a dynamo with the terminals of the battery and sending a current through it. This current reverses the chemical action, which goes on during the discharge of the battery.

A **Storage Battery** furnishes the most convenient source of current for performing all sorts of electrical experiments. It is capable of giving more current for a longer period than dry cells and is not expensive, for it merely requires recharging and does not have to be thrown away each time the current is used up.

The storage cell described below is made in a very simple manner and will well repay any time or expense spent in its construction.

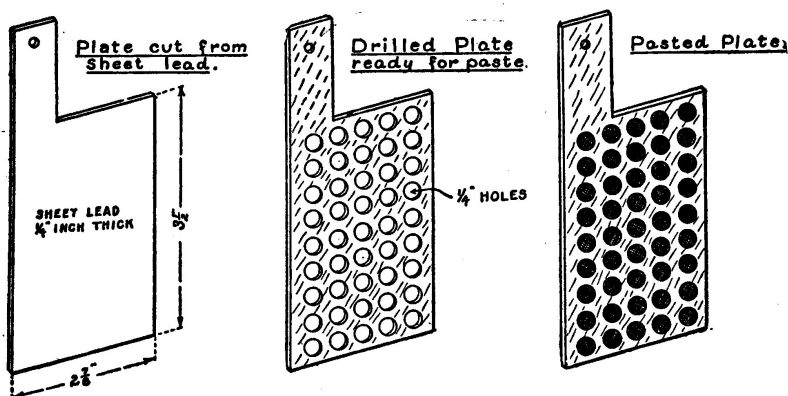

Fig. 71.—How to make the Plates for a Storage Cell.

The plates are cut out of a large sheet of lead, one-quarter of an inch thick. They may be made any convenient size to fit the jars which the experimenter

may have at hand. We will assume that they are to be made two and seven-eighths inches wide and three and one-half inches long. They will then fit the rectangular glass storage cell which is already on the market and can be procured from dealers in electrical supplies.

A long terminal or lug is left projecting from the plate as shown in Figure 71.

Any number of plates may be placed in a single cell, depending of course upon the size of the glass jar. We will suppose that three will just fit the jar nicely. An odd number of plates should always be used, so that a positive plate may come between two negatives.

Each cell will give two volts regardless of the number of plates. Increasing the number of plates, however, will give the cell a greater amperage capacity and make the charge last longer. Three cells (six volts) will form a convenient set for running small fan-motors, miniature lights, etc.

Cut out nine plates and pile them up in sets of three with a piece of thin wood (cigar-box wood) between each pair of plates. Clamp them together in a vise and bore full of one-quarter-inch holes.

The plates are now ready for pasting. They are placed on a smooth slab of stone or glass and pasted with a stiff mixture of red lead and sulphuric acid (two parts water to one part acid). The paste must be pressed carefully into the recesses of the plates with a flat stick. They are then laid aside to dry and harden.

After they have thoroughly dried they should be assembled as in Figure 73 with one positive plate between two negative ones. The wooden "separators" are easily cut out of wood with a saw and penknife. The thin wood used in the construction of peach baskets is the best for the purpose. The separators should be made the same size as the lead battery plates.

Each group of plates is then placed in a jar containing a mixture of sulphuric acid and water (4 parts water to one part acid). In mixing the acid be very careful to pour the acid into the water, stirring the mixture slowly at the same time, and not the water into the acid.

The plates are now ready for "forming." The binding-posts on the lugs of the plates may be secured from the carbons of some old dry cells. The simplest method of "forming" the plates is to use four gravity cells and "form" one storage cell at a time.

Connect the positive pole (copper) of the gravity battery to the positive pole (center-plate) of the storage cell and the negative (zinc) of the gravity battery to the negative (outside plates) of the storage cell. Allow the current to flow through the storage battery for several days or until the positive plate turns to a dark chocolate-brown color and the negatives to a gray-slate.

After the cells have once been "formed" all that they require is occasional

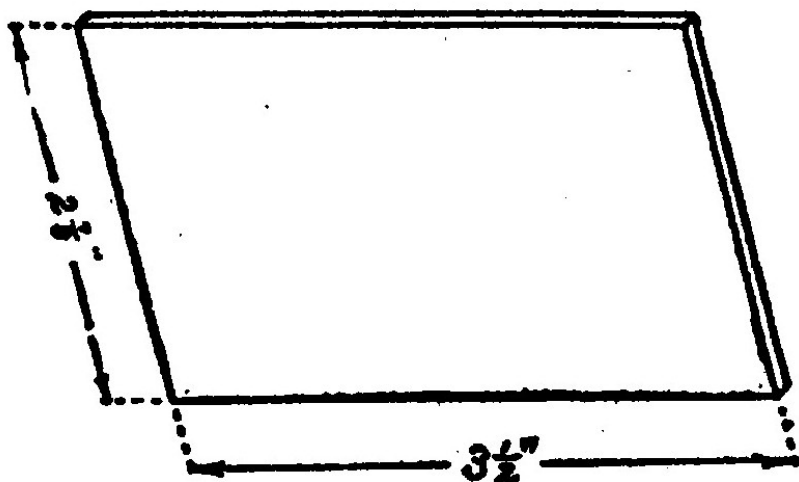

Fig. 72.—The Wood Separator.

recharging from gravity cells or from a dynamo, by connecting the positive pole of the charging current to the positive plates of the storage cells and the negative pole to the negative plates.

When the cells are fully charged, bubbles of gas will rise freely from the plates. If a dynamo is used it must be "shunt" wound and not a "series" machine. Recharging will only require about one-quarter of the time consumed in forming.

It is a very good plan to connect twelve gravity cells in series and use them to recharge the storage battery. The gravity cells can always be kept connected to the storage cells when the latter are not in use and thus remain fully charged and ready to supply their maximum current.

After the cells have been in use for some time, it is a good plan to lift out the plates and remove all sediment which has settled to the bottom of the jars.

A set of three such storage cells will have an E. M. F. of over six volts. Any number may be connected up in series in order to obtain a higher voltage.

Storage batteries are usually rated in "ampere hours." An ampere hour is the amount of current represented by one ampere flowing for one hour. A ten-ampere-hour storage battery will deliver:

One ampere for ten hours

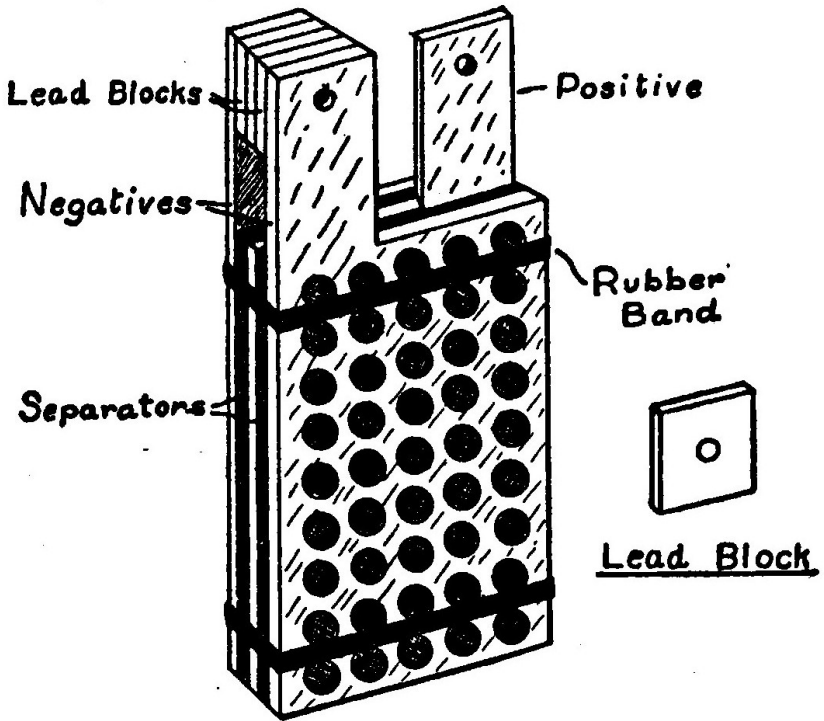

Fig. 73.—The Complete Element for a Storage Cell.

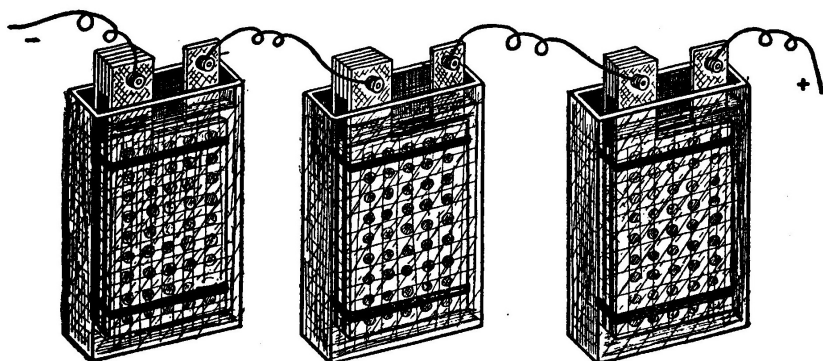

Fig. 74.—A Battery of Home-Made Storage Cells.

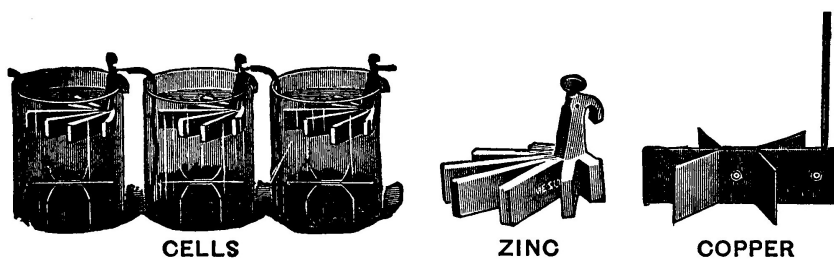
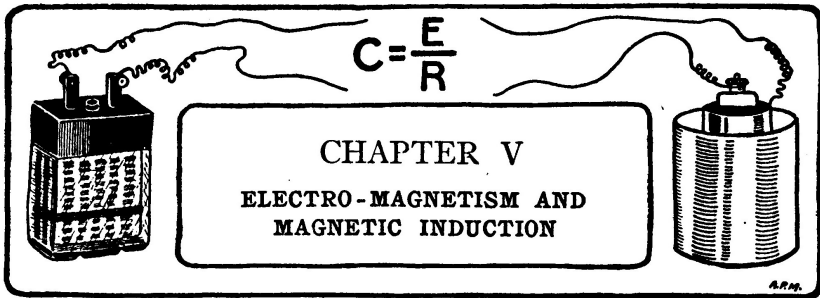

Fig. 75.—Gravity Cells. These consist of zinc and copper elements, immersed in a zinc-copper sulphate solution. They cannot be easily made, and are best purchased. The illustration also shows the star-shaped copper and "crowfoot" zinc element used in a gravity cell.

Two amperes for five hours
 Five amperes for two hours
 Ten amperes for one hour

In other words, the result obtained by multiplying the number of amperes by the time in hours is the *ampere hour capacity*.

A dynamo must have an E. M. F. of about ten volts in order to charge a three-cell storage battery.



CHAPTER V ELECTRO-MAGNETISM AND MAGNETIC INDUCTION

Connect two copper wires to a voltaic cell and stretch a portion of the wire over a compass needle, holding it parallel to it and as near as possible without touching. Then bring the free ends of the wires together and observe that the needle is deflected and after a few movements back and forth comes to rest at an angle with the wire.

Next form a rectangular loop of wire and place the needle within it as in Figure 77. A greater deflection will now be obtained. If a loop of several turns is formed, the deflection will be still greater.

These experiments were first performed by Oersted, in 1819, and show that the region around a wire carrying a current of electricity has *magnetic* properties.

Another interesting experiment showing the magnetic effect of a current of electricity when passing through a wire may be performed by connecting a heavy copper wire to two or three bichromate-of-potash cells. Dip the wire into a pile of fine iron filings and a thick cluster of them will adhere to the wire as in Figure 78.

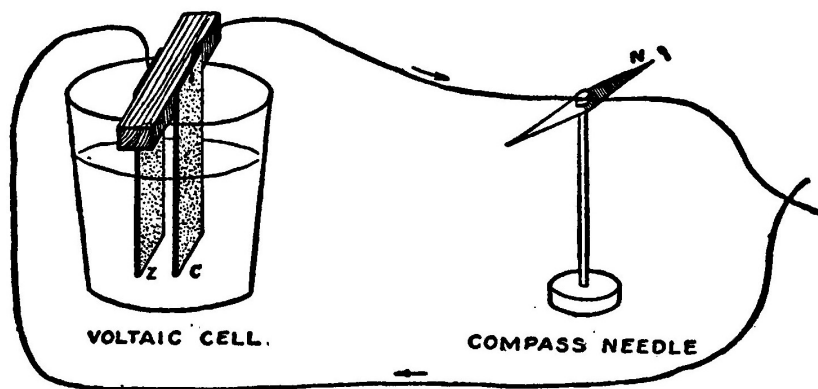

Fig. 76.—A Current of Electricity flowing through a Wire will deflect a Compass Needle.

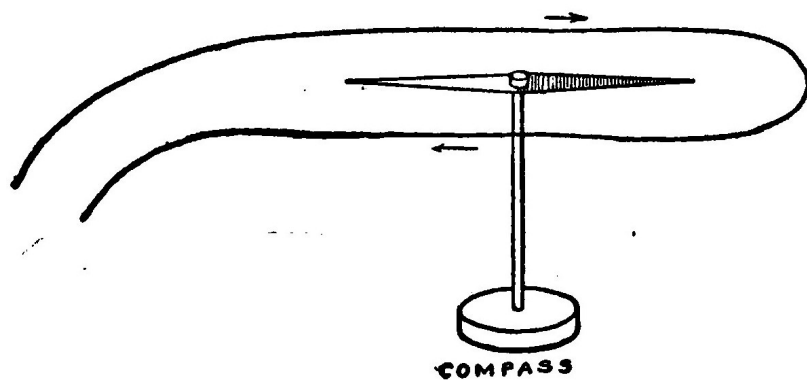

Fig. 77.—If a Loop of Wire is formed about a Compass Needle, the Deflection will be greater.

As soon as the circuit is broken so that the current of electricity ceases flowing, the filings will fall off, showing that the magnetic effect ceases with the current.



Fig. 78.—Iron Filings clustered on a Wire carrying a Current of Electricity.

These three simple experiments have shown that if a current of electricity is passed through a copper wire, the wire will deflect a compass needle, attract to itself iron filings, etc., as long as the current continues to flow. As soon as the current is shut off, the magnetic effect is *destroyed*.

The region in the neighborhood of a wire carrying a current is a *field of force* through which lines of magnetism are flowing in exactly the same way that they do in the neighborhood of a bar or horseshoe magnet.

This is readily shown by punching a small hole in a piece of cardboard, and passing a wire carrying a strong current of electricity through the hole.

If a few iron filings are sifted on the cardboard and the latter jarred slightly with a pencil as they fall, they will arrange themselves in circles with the wire at the center, forming a magnetic phantom and showing the paths of the lines of magnetic force.

By forming the wire into a coil as in Figure 80 the magnetic field generated is much stronger and more plainly seen, for then the combined effect of the wires is secured.

Roll up a small paper tube about 1/2 inch in diameter and four inches long. Wind neatly on the tube three layers of No. 18 insulated copper wire. Pass an electric current through it from two or three cells of a battery, and test its magnetic properties by bringing it near a compass needle. It will be found that the coil possesses very marked magnetic properties, and will readily cause the needle to swing about, even though it is held quite a distance away.

If an iron bar is placed inside of the paper tube, the magnetic effect will be greatly increased.

The presence of the iron bar inside of the coil of wire greatly increases the number of lines of force running through the coil.

When a bar is not used, many of the lines of force leak out at the sides of the coil, and but few extend from end to end. The effect of the iron core is not only

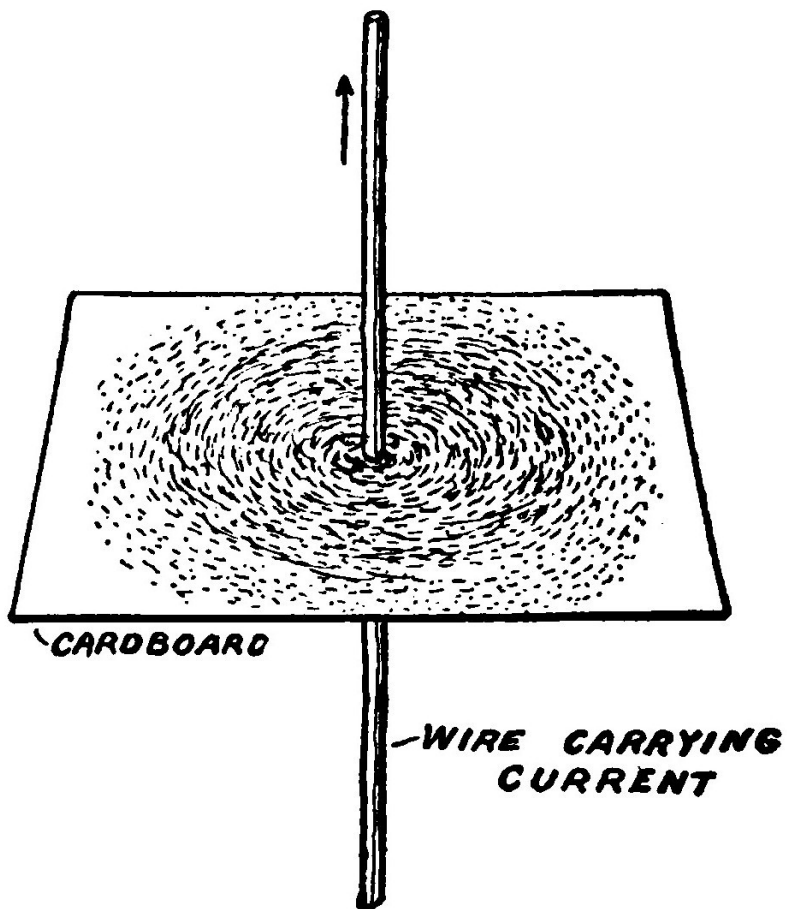

Fig. 79.—Magnetic Phantom formed about a Wire carrying a Current of Electricity.

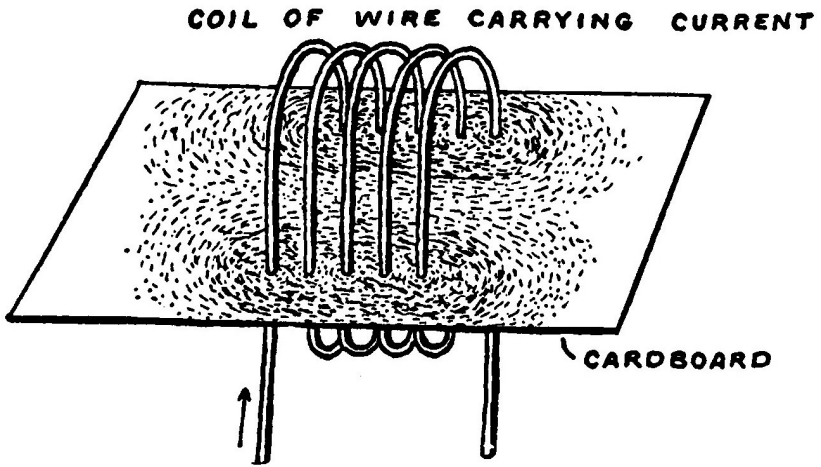

Fig. 80.—Magnetic Phantom formed about several Turns of wire.

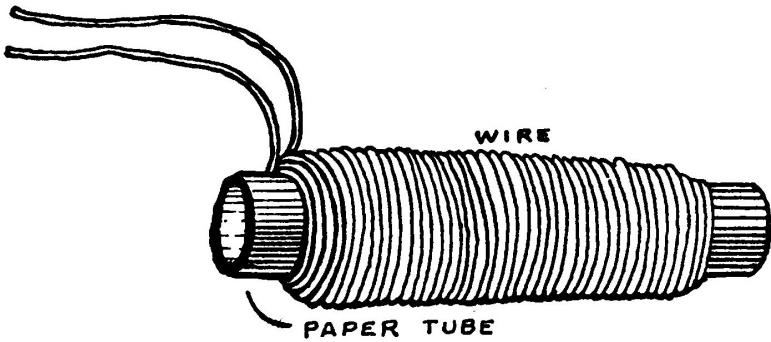

Fig. 81.—Paper Tube wrapped with Wire for Experimental Purposes.

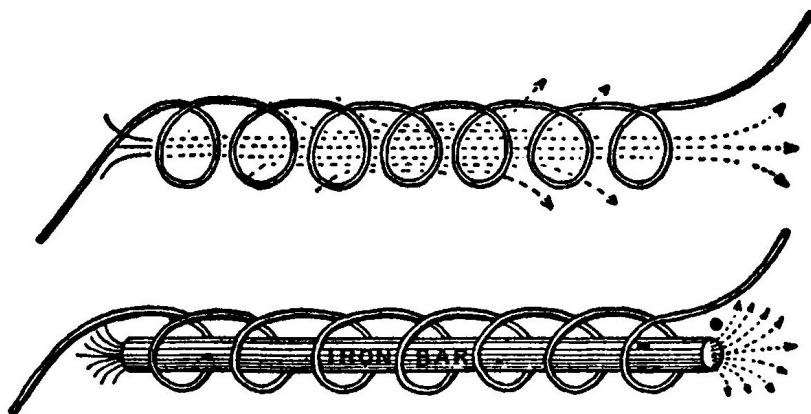

Fig. 82.—Showing how the Lines of Force "Leak" at the sides of the coil, from a Coil of Wire, and how they are concentrated by an Iron Core.

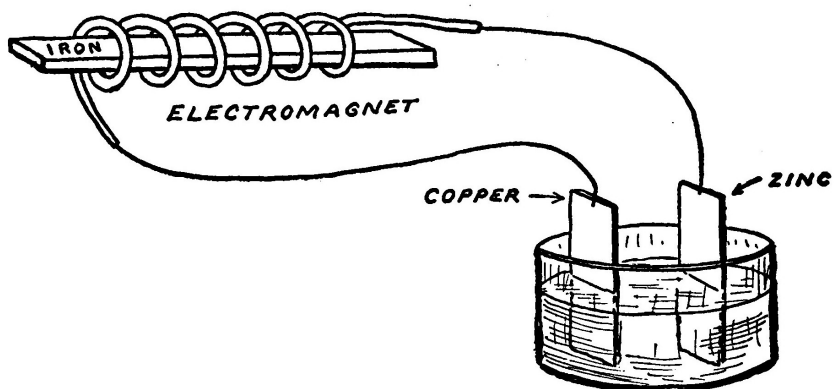

Fig. 83.—The Principle of an Electro-Magnet.

to diminish the leakage of the lines of force, but also to add many more to those previously existing. Hence the magnetic strength of a coil is greatly increased by the iron core.

A coil of wire wrapped around an iron core forms an *electro-magnet*.

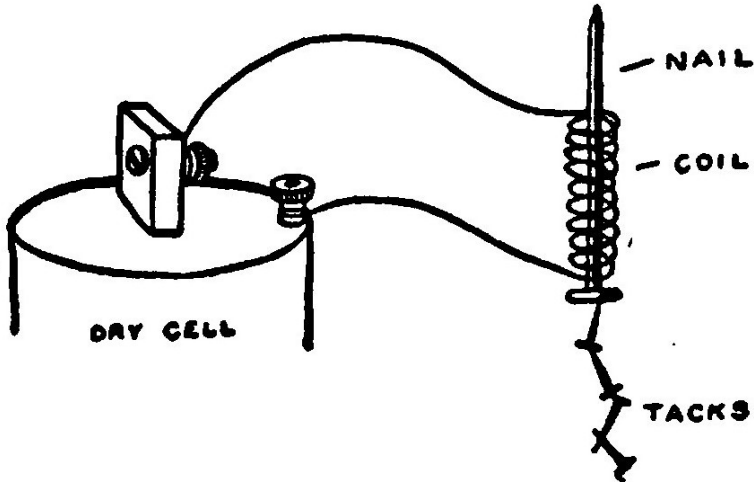

Fig. 84.—if you wrap some insulated Wire around an Ordinary Nail and connect it to a Battery, it will become an Electro-Magnet.

If you wrap some insulated wire around an ordinary nail and connect it to one or two cells of a battery it will become an electro-magnet and pick up bits of iron and steel.

If you wind the wire around a small paper tube into which a nail will slide easily, the coil will draw the nail in when the current is turned On. A hollow coil of this sort is called a solenoid.

Electro-magnets and solenoids play a part in the construction of almost all electrical machinery. They form the essential parts of dynamos, motors, telephone receivers, telegraph relays and sounders, and a host of other devices.

The form usually given to an electro-magnet depends upon the use to which it is to be put. The horseshoe is the most common. This consists of two electro-magnets mounted on a yoke and connected so that the two free poles are North and South.

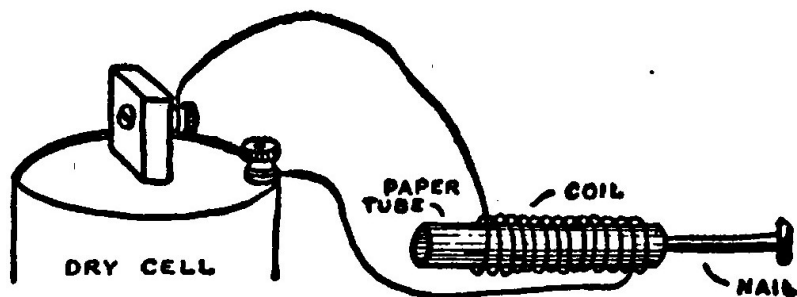

Fig. 85.—If you wind the Wire around a small Paper Tube into which a Nail will slide easily, the Coil will draw the Nail in when the Current is turned on.

Electro-magnets are made on a huge scale for lifting large castings and heavy pieces of iron. Such magnets are used in the great steel mills and in factories where nails, bolts, etc., are manufactured.

Monster electro-magnets can be seen in wonderful perfection at the great steel mill at Gary, Indiana.

Ships bring the ore down the lakes to Gary, where great steel jaws lift it out of the hold of the boat and carry it to the furnaces.

After being melted, great machines pour it out. It is divided into huge ingots, and these, while hot, are carried to the first part of the rolling mill.

The ingot is squeezed by a machine, made longer and narrower, then squeezed again and made still longer and narrower.

It is started on its journey along the rollers of the mill, squeezed and pressed here and there, as it travels hundreds of yards—no hand ever touching it. It finally arrives, a red-hot steel rail, the right shape and the right length.

During this time the steel has made a long journey and changed from a shapeless ingot to a finished rail, handled entirely by machinery guided and controlled by one or two operators, pressing levers and switches.

When almost finished, the rail slides down an incline before a man who grasps the rail with huge pinchers, and standing at one end, runs his eye along it. As he looks along the rail he sees the defects, moves the left or the right hand, and another man at the levers of the straightening machine, straightens the rail as directed.

And soon there are ten rails, perfectly straight, side by side, with more coming down the incline to meet the glance of the man's eye.

They are still too hot for any man's touch and so a man sitting in a tower touches an electric switch, and along the overhead rails there comes gliding a monster electro-magnet.

The magnet moves along, drops down upon the ten rails, lying side by side and weighing thousands of pounds. The man in the tower presses another switch, thus turning on the current, and electricity glues the rails to the magnet.

The ten rails are lifted at once, as easily as you would lift a needle with your horseshoe magnet; they are carried to a flat-car, and when lowered in position, the current is turned off, releasing the rails, and the magnet travels back for another load.

Induction

In 1831, Michael Faraday, a famous English chemist and physicist, discovered that if a magnet be suddenly plunged into a hollow coil of wire, a momentary current of electricity is generated in the coil. As long as the magnet remains motionless, it induces no current in the coil, but when it is moved back and forth, it sets up the currents. The source of electrical energy is the mechanical work done in moving the magnet.

The medium which changes the mechanical energy into electricity is the magnetic field which we have already seen exists in the neighborhood of a magnet.

A current of electricity produced in a coil in such a manner is said to be an *induced* current and the phenomenon is that known as *magnetic induction*.

Magnetic induction is met in the dynamo, induction coil, telephone, transformer, some forms of motors, and a number of other electrical devices.

A simple experiment in which electricity is produced by magnetic induction may be performed by winding a number of turns of fine insulated wire around the armature or keeper of a horseshoe magnet, leaving the ends of the iron free to come in contact with the poles of the permanent magnet. Connect the ends of the coil to a sensitive galvanometer,¹ the ends of the armature being in contact with the poles of the horseshoe magnet as shown in Figure 87.

Keeping the magnet fixed, suddenly pull off the armature. The galvanometer will show a momentary current. Suddenly bring the armature up to the poles of the magnet; another momentary current in the reverse direction will flow through the circuit.

The fact that it is a reverse current is shown by the actions of the gal-

¹See chapter on Measuring Instruments.

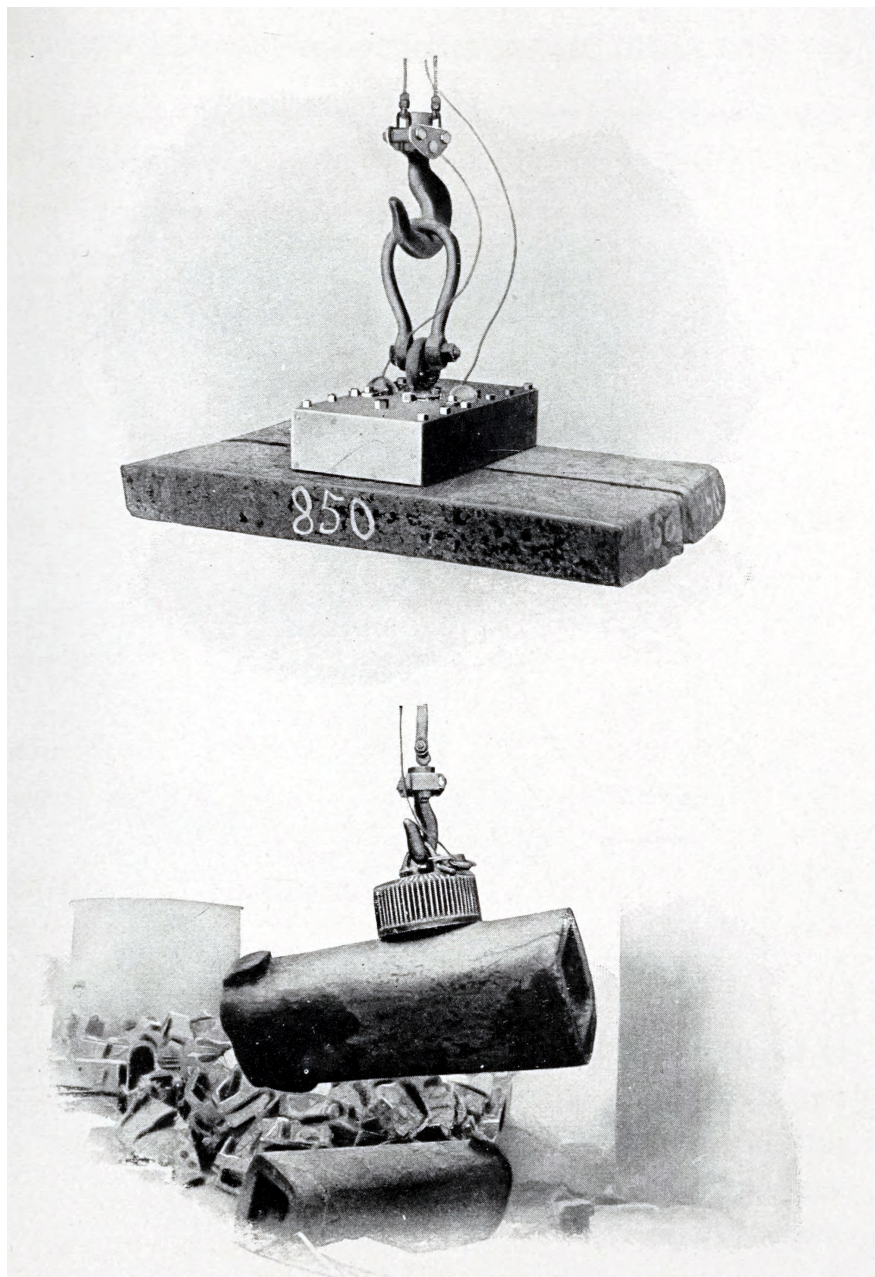

By permission, from "Solenoids" by C. R. Underhill. Lifting-Magnets of the type known as Plate, Billet, and Ingot Magnets.

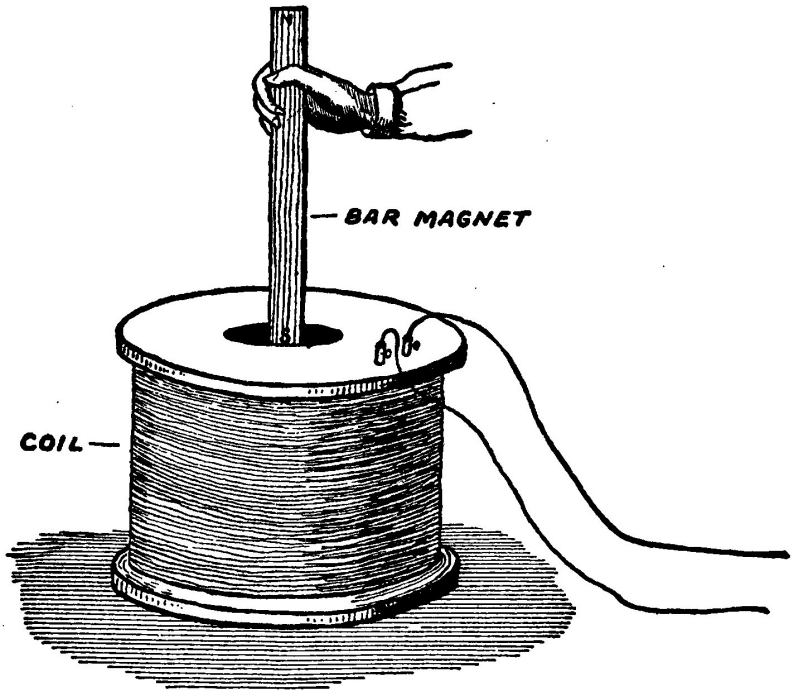

Fig. 86.—Showing how a Current of Electricity may be induced by a Bar Magnet and a Coil.

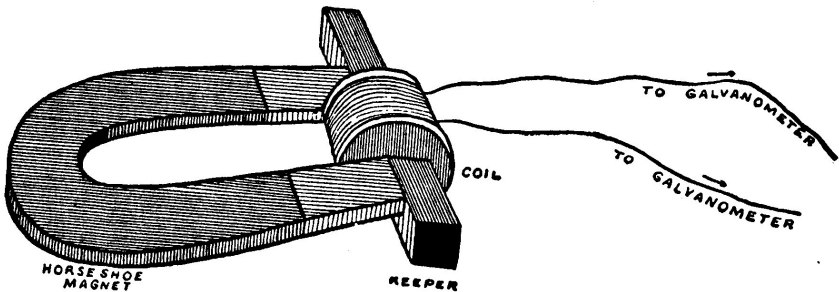
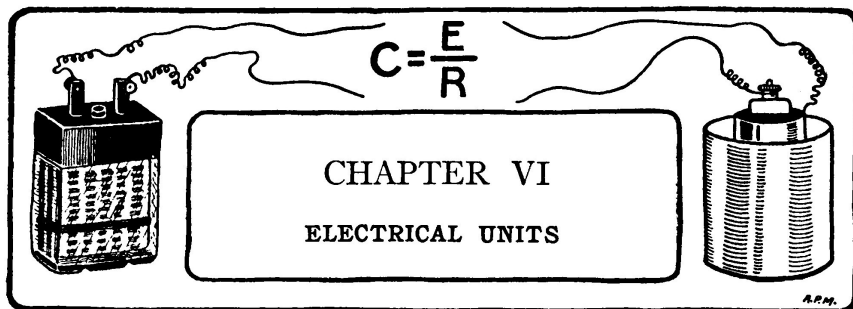

Fig. 87.—A Horseshoe Magnet and a Coil arranged to produce Electric Currents by Induction.

vanometer for it will be noticed that the needle swings in the opposite direction this time.

It will also be noticed that no current is produced when the coil and magnet are stationary. Current is only generated when the coil and magnet are approaching one another or moving apart suddenly.

This is because it is only then that the magnetic field is changing. The field is strongest nearest the magnet, and therefore if either the magnet or the coil of wire is moved, the strength of that part of the field which intersects the coil is changed. Induced currents can only be generated by a *changing* magnetic field.



CHAPTER VI ELECTRICAL UNITS

The Ampere

There are certain terms used in the electrical field to distinguish various properties and qualities of the electrical current with which it is well for the young experimenter to acquaint himself.

One of the first units usually required, in order to make intelligent comparisons, is a unit of measure. The *quart* is the unit of *measure* commonly applied to liquids and is based upon the amount of space occupied by a certain volume. The *pound* is a unit of weight which determines a certain amount of any substance by comparing the force which gravity exerts in pulling it to the earth with the same effect of gravity on another standard "weight."

Electric current is invisible and weightless, and for these and other reasons cannot be measured by the quart or weighed by the pound. The only way that it can be measured is by means of some of the effects which it produces. Either the chemical, electro-magnetic, or the heating effects may be made the basis of a

system of measurement.

The first method used to measure electric current was the chemical one.

If a current is passed through a solution of a chemical called copper *sulphate* (blue vitriol) by means of two copper plates, *copper* will be deposited on one plate and dissolved from the other. If the current is furnished by a battery the copper will be deposited on the plate connected with the zinc of the battery. If the current is allowed to flow for a short time and the two copper plates are then taken out and weighed it will be found that one plate is considerably heavier than the other.

The copper has been taken from one plate and deposited on the other by the *electric currents*. The amount of electric current which will deposit 1.177 grammes of copper in an hour is called an *ampere*. The ampere is the unit of electrical current measurement, and implies quantity or amount.

The chemical method of measuring current was at one time put to practical service in the distribution of electric current for lighting and power. Many years ago the house meters, used to measure the current, consisted of a jar containing two copper plates. The current used in the house would cause copper to deposit on one plate, and by weighing the plate the power company could determine the amount of current used, and thereby the amount of the bill. The meters nowadays make use of the magnetic effects of the current instead of the chemical, as described later on.

The Volt

For purposes of explanation the electric current may be likened to a stream of water flowing through a pipe.

If you hold your thumb over the end of a water-pipe through which water is flowing it will push your thumb away because of the *pressure* which the water exerts.

Electric currents also exert a *pressure*, only it is not called pressure in electrical parlance, but, spoken of as *electromotive force* or *potential*.

The pressure of the water enables it to pass through small openings and to overcome the resistance offered by the pipe.

Wires and other electrical conductors do not offer a perfectly free path to an electric current, but also possess a resistance. It is the potential of the electromotive force which overcomes the resistance and pushes the current through the wire.

Advantage has been taken of the fact to fix a unit of electrical pressure called the *volt*. The pressure of the water in a water-pipe is measured in pounds, but the pressure of an electric current in a wire is measured by *volts*. The volt is the unit of electrical force which will cause a current of one ampere to flow

through a resistance of one *ohm*.

The Ohm

The ohm is the unit of electrical resistance. The standard ohm is the resistance offered by a column of pure mercury having a section of one square millimeter and a length of 106.28 centimeters at a temperature of 0° centigrade.

The pressure which will force sufficient current through such a column of mercury to deposit 1.177 grammes of copper in one hour is a volt, and in doing so has passed a current of one ampere through a resistance of one ohm.

The units ohm, ampere, and volt, were named in honor of the three great electricians: Ohm, Ampère, and Volta.

These three units bear a very close relation to each other which is explained by Ohm's Law.

Ohm's Law is a simple statement of facts which it is well for the young electrician thoroughly to understand, for it might almost be said to be the basis of design of almost all electrical instruments.

It is simply this: The strength of a current equals the voltage divided by the resistance. It may be expressed in symbols by: $C = E/R$. Where C is the current in amperes, E is the potential in volts, and R the resistance in ohms.

By way of a simple example, we will suppose that a small telegraph sounder is connected to a battery and that the voltage of the battery is *ten volts*. We will further suppose that the resistance of the sounder connecting wires and the battery itself is *five ohms*. Knowing these two facts, it is very easy to find out how many amperes are flowing through the sounder by substituting these values in the equation as follows:

$$C = E/R$$

$$E = 10 \text{ volts and } R = 5 \text{ ohms}$$

$$\text{therefore } C = 10/5 \text{ or } 2 \text{ amperes}$$

In order to indicate fractions or very large values of the ampere, volt, and ohm, it is customary to use the following terms:

Milli-volt = 1/1000 of a volt
 Mill-ampere = 1/1000 of an ampere
 Kilo-volt = 1000 volts
 Meg-ohm = 1,000,000 ohms

The Watt

It is no doubt perfectly plain that the water in a certain size of pipe at a pressure of 100 lbs. is more powerful than a stream of water in the same size of pipe at 25 lbs. pressure.

Likewise a current of electricity represents more power at 100 volts potential than the same current would at 25 volts. The unit of electrical power is called the *watt*. A watt is represented by a current of one ampere flowing through a wire at a potential of one volt.

The number of watts is found by multiplying the voltage by the amperage. In the case of the sounder and battery used as an example to explain Ohm's Law, and where the voltage was 10 and the amperage found to be 2, the number of watts is 10×2 , or 20 watts.

Seven hundred and forty-six watts represent one electrical horse-power. One thousand watts are called a *kilo-watt*.

The Coulomb

So far, none of the units have taken into consideration the element of time.

If water should be permitted to run out of a pipe into a tank until ten gallons had passed it would not be possible to tell at what rate the water was flowing by knowing that ten gallons had passed unless it were also known how long the water had been flowing. Ten gallons per minute or ten gallons per hour would indicate the rate of flow.

One ampere flowing for one second is the electrical unit of flow. This unit is called the *coulomb*.

One ampere flowing for one hour is called an *ampere hour*. The number of ampere hours is found by multiplying the current in amperes by the time in hours.

A battery may be said to have a capacity of 10 ampere hours. This means that it will deliver one ampere for 10 hours ($1 \text{ ampere} \times 10 \text{ hours} = 10 \text{ ampere hours}$) or 2 amperes for 5 hours ($2 \text{ amperes} \times 5 \text{ hours} = 10 \text{ ampere hours}$).

The same element of time enters into consideration in connection with the watt. One watt flowing for one hour is a *watt hour* and one kilowatt flowing for one hour is a *kilo-watt hour*.

The Difference between Alternating and Direct Currents

There are two distinct kinds of electric current supplied for lighting and power, one known as *direct* current and the other as *alternating*.

A *direct current* is one which passes in one direction only. It may be repre-

sented by a straight line, as *A* in Figure 88.

An alternating current is one which reverses its direction and passes first one way and then the other. It may be represented by a curved line, shown in Figure 88. It starts at *zero*, and gradually grows stronger and stronger. Then it commences to die away until no current is flowing. At this point it reverses and commences to flow in the opposite direction, rising gradually and then dying away again.

This is repeated a definite number of times per second; when the current rises from zero, reverses and returns to zero, it is said to pass through a *cycle*.

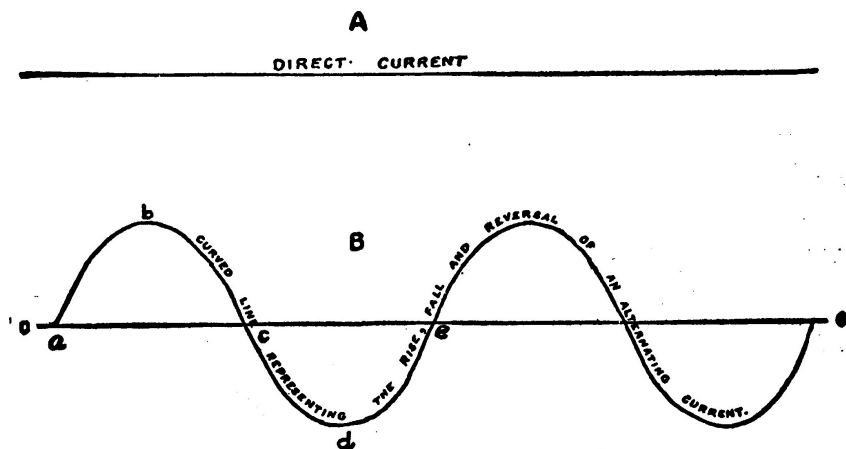

Fig. 88.—Graphic Representation of a Direct and an Alternating Current.

The part of the curved line from *a* to *b* in Figure 88 represents the first part of the current, when it is rising. From *b* to *c* represents its fall. The point at which the curved line crosses the straight line is zero. At *c* the current crosses the line and commences to flow in the opposite direction until it reaches *d*, at which point it dies away and again crosses the line to flow in its original direction and *repeat the cycle*.

In electrical parlance, that part of the current from *a* to *c* or from *c* to *e* is known as an *alternation*. From *a* to *e* is called a *cycle*.

The reason why alternating current is often used in place of direct current is that it can be sent over the wires for long distances more economically than direct current. This is more fully explained farther on in the chapter dealing with a step-down transformer.

The number of *cycles* taking place in one second is known as the *frequency* of the current. The usual *frequency* of commercial alternating currents is 60 cycles per second or 7200 alternations per minute.

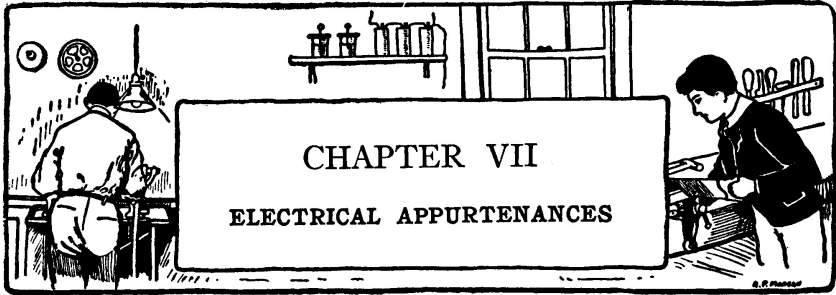

CHAPTER VII ELECTRICAL APPURTENANCES

Wires

Electric currents are usually led from place to place, at will, by means of conductors called *wires*. There are a great many kinds of wires, each adapted to some special purpose.

Wires are usually covered with a material called an *insulator*, in order to prevent the loss of electric current due to the wires coming into contact with other bodies or circuits. Insulators are substances which do not conduct electricity.

Wires which are *insulated* by heavy braids of cotton fiber and then impregnated with some compound, such as creosote, are called *weather-proof* wires, and are best adapted to outside service, where they must be exposed to the action of the elements.

The wires used for interior wiring in buildings, etc., are usually insulated with rubber, over which is placed a cotton braid to protect the rubber.

Rubber cannot well be used as an insulator for all wires, although its insulating value is very great, owing to the fact that it deteriorates under many conditions.

Rubber-covered and weather-proof wires are made in a variety of insulations. Some may have only one insulating layer, while others have a great many. Different substances are used as insulators to adapt the wire to some special pur-

pose. Copper is usually the only metal used to form the wire or conductor itself. The reason for this is that copper is a better conductor than any other metal except those known as precious metals, such as gold and silver, the cost of which prohibits their use for such purposes. The wire may be solid, or made up of a number of small conductors so that it is flexible.

The various combinations of insulating layers, together with either a solid or a stranded conductor, have made possible a variety of current-carriers, known as:

Theater or Stage Cable
Elevator Cable
Fixture Wire
Telephone Wire
Mining Cable
Feeder Cable
Brewery Cord
Heater Cord, etc.

depending upon the special use for which they were designed.

NUMBER, DIAMETER, WEIGHT, LENGTH, AND RESISTANCE OF COPPER WIRE

GAUGE.	DIAMETER.	SECTIONAL AREA.	CAPACITY.	OHMS.			FEET.		POUNDS.	
				Per 1,000 Feet.	Per Mile.	Per Pound.	Per Pound.	Per Ohm.	Per 1,000 Feet.	Per Ohm.
0000	.450	211600.	312.	.04906	.25903	.000077	1.56122	20497.7	640.51	12987.
000	.40364	167805.	262.	.06186	.32664	.00012	1.9687	16255.27	507.95	8333.
00	.3648	133079.	220.	.07801	.41187	.00019	2.4824	12891.37	402.83	5203.
0	.32486	105534.	185.	.09831	.51909	.00031	3.1303	10223.08	319.45	3225.
1	.283	83694.	156.	.12404	.65490	.00049	3.94714	8107.49	253.34	2041.
2	.25763	66373.	131.	.1563	.8258	.00078	4.97722	6429.58	200.91	1282.
3	.22942	52634.	110.	.19723	1.0414	.00125	6.2765	5098.61	159.32	800.
4	.20431	41743.	92.3	.24869	1.313	.00198	7.9141	4043.6	126.35	505.
5	.18194	33102.	77.6	.31361	1.655	.00314	9.97983	3206.61	100.20	318.
6	.16202	26251.	65.2	.39546	2.088	.00499	12.5847	2542.89	79.462	200.
7	.14423	20817.	54.8	.49871	2.633	.00792	15.8666	2015.51	63.013	126.
8	.12849	16510.	45.1	.6529	3.3	.0125	20.0007	1599.3	49.976	80.
9	.11443	13094.	38.7	.7892	4.1	.0197	25.229	1268.44	39.636	50.
10	.10183	10382.	32.5	.8441	4.4	.0270	31.8212	1055.66	31.426	37.
11	.090742	8234.	27.3	1.254	6.4	.0501	40.1202	797.649	24.924	20.
12	.080803	6530.	23.	1.580	8.3	.079	50.5906	632.555	19.766	12.65
13	.071961	5178.	19.3	1.995	10.4	.127	63.7948	501.63	15.674	7.87
14	.064084	4107.	16.2	2.504	13.2	.200	80.4415	397.822	12.435	5.00
15	.057058	3257.	13.6	3.172	16.7	.320	101.4365	315.482	9.859	3.18
16	.05082	2583.	11.5	4.001	23.	.512	127.12	250.184	7.819	1.95
17	.045257	2048.	9.6	5.04	26.	.811	161.29	198.409	6.199	1.23
18	.040303	1624.	8.1	6.36	33.	1.29	203.374	157.35	4.916	.775

The wires which the young experimenter is likely to use in his work the most are known as *magnet wires*, and are used for making electro-magnets, coils, and various windings. Magnet wires may be insulated with either silk, cotton, or enamel.

GAUGE.	DIAMETER.	SECTIONAL AREA.	CAPACITY.	OHMS.			FEET.		POUNDS.	
				Per 1,000 Feet.	Per Mile.	Per Pound.	Per Pound.	Per Ohm.	Per 1,000 Feet.	Per Ohm.
19	.03589	1288.	8.25	43.	2.11	256.468	124.777	3.899	.473
20	.037061	1021.	10.12	53.	3.27	323.399	98.9533	3.094	.305
21	.028462	810.	12.76	68.	5.20	407.815	78.473	2.452	.192
22	.025347	642.	16.25	85.	8.35	514.193	62.236	1.945	.119
23	.022571	509.	20.30	108.	13.3	648.452	49.3504	1.542	.075
24	.0201	404.	25.60	135.	20.9	817.688	39.1365	1.223	.047
25	.0179	320.	32.2	170.	38.2	1031.038	31.0381	.9699	.030
26	.01594	254.	40.7	214.	52.9	1300.180	24.0131	.7692	.0187
27	.014195	201.	51.3	270.	84.2	1639.49	19.5191	.6099	.0112
28	.012641	159.8	64.8	343.	134.	2067.304	15.4793	.4837	.0073
29	.011257	126.7	81.6	432.	213.	2606.959	12.2854	.3835	.0047
30	.010025	100.5	103.	538.	338.	3287.084	9.7355	.3002	.0029
31	.008928	79.7	130.	685.	539.	4414.49	7.72143	.2413	.0018
32	.00795	63.	164.	865.	856.	5226.915	6.12243	.1913	.0011
33	.00708	50.1	206.	1033.	1357.	6590.41	4.85575	.1517	.00076
34	.006304	39.74	260.	1389.	2106.	8312.8	3.84960	.1204	.00046
35	.005614	31.5	328.	1820.	3521.	10481.77	3.05305	.0950	.00028
36	.005	25.	414.	2200.	5469.	13214.16	2.4217	.0757	.00018
37	.004453	19.8	523.	2765.	8742.	16659.97	1.92086	.06803	.00014
38	.003965	15.72	660.	3486.	13772.	21013.25	1.52292	.04758	.00007
39	.003531	12.47	832.	4395.	21896.	26496.237	1.20777	.03755	.00064
40	.003144	9.88	1049.	5542.	34823.	33420.63	0.97984	.02992	.00024

Silk-covered and cotton-covered wires may be obtained with either a single or double covering.

Wires with a single covering of silk or enamel are used when it is desirable to save space, for the covering of these two classes of magnet wires is thinner than either the cotton or double-silk-covered wire, and consequently they require less room for winding.

The size of the wire is indicated by its diameter, and in the United States is measured by the Brown and Sharpe gauge, often indicated by the term, "B. & S."

The preceding table shows the various sizes of wire of the Brown and Sharpe gauge, and also several of their characteristics, such as weight, resistance, etc.

Insulators

The covering placed over wires is not the only precaution taken to insulate them, but in the case of permanent wiring they are usually mounted on glass or porce-

lain supports.

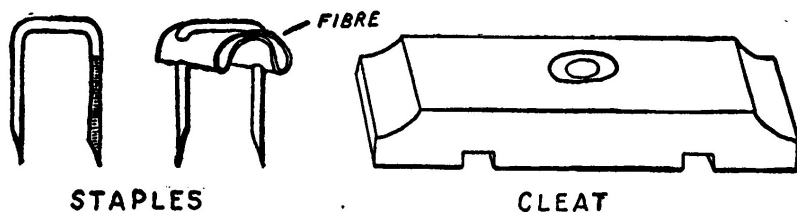

Fig. 89.—Staples and Wooden Cleat used for running Low Voltage Wires.

Wires used for batteries, bells, telephones, etc., operated by batteries and where the voltage is not over 20 volts, may be run under *insulated* staples or wooden cleats inside of a building. If outside and exposed to the weather, they should be mounted on suitable glass or porcelain knobs.

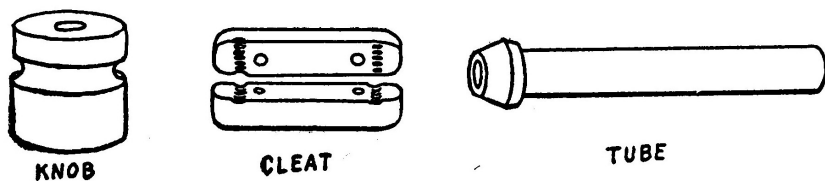

Fig. 90.—Porcelain Insulators to support Electric Light Wires.

Electric-light wires for inside use are commonly supported by insulators made of porcelain and known as cleats, knobs, and tubes according to the shape.

Telegraph, telephone, and power lines are usually supported by glass knobs or large porcelain insulators which screw on to wooden pins.

Binding-Posts

Binding-posts are the most convenient device to make quick connections between wires and other parts of electrical apparatus.

Binding-posts may be either made or purchased. Those which are purchased are of course the best, and will add greatly to the appearance of any instrument upon which they are mounted.

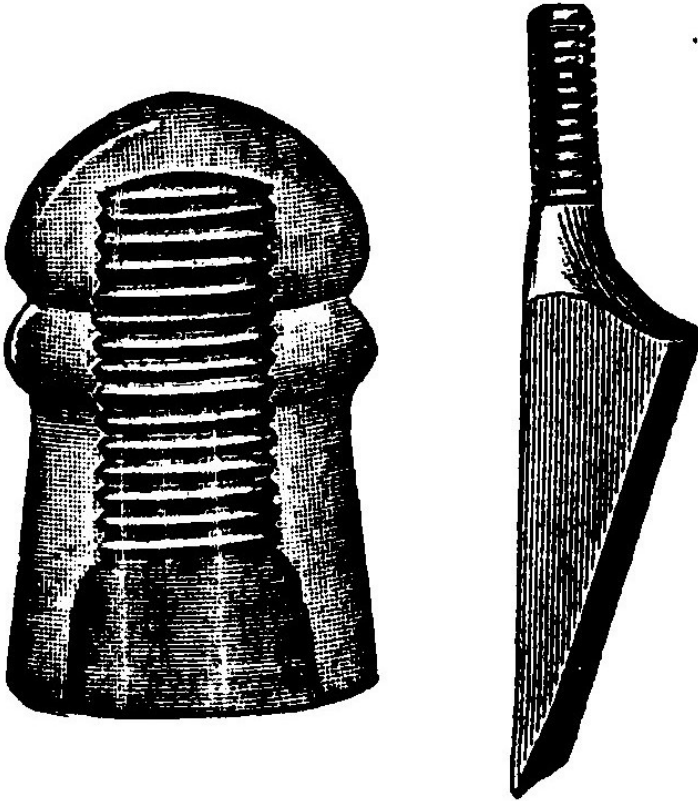

Fig. 91.—Glass Insulator Binding-Posts and Pin used to support Telegraph and Telephone wires.

Several of the best-known types of manufactured posts are shown in Figure 92.

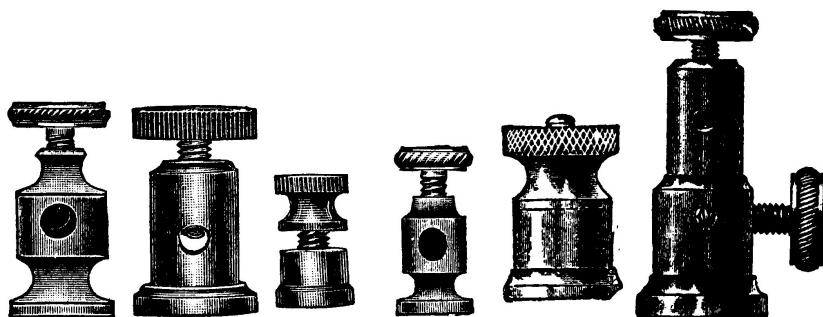

Fig. 92.—Types of Binding-Posts.

Figure 93 shows different ways of making simple binding-posts and connectors from screws, washers, screw-eyes, and strips of metal. The drawings are self-explanatory and should need no comment.

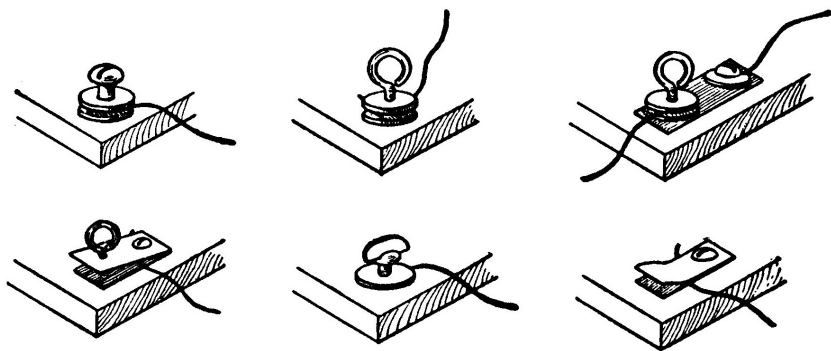

Fig. 93.—Home-made Binding-Posts.

The screws and nuts obtainable from old dry cells are very convenient to use for binding-posts and other similar purposes.

Switches and Cut-Outs

Switches and cut-outs are used in electrical work for turning the current on and off.

If the experimenter chooses to make them himself, care should be taken, to construct them in a strong and durable fashion, for they usually are subjected to considerable use, with consequent wear and tear.

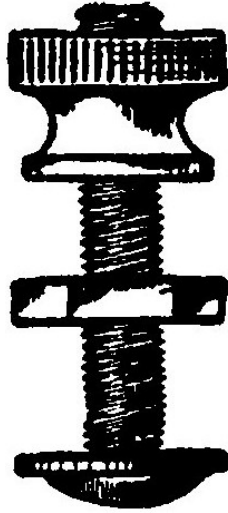

Fig. 94.—Binding-Post removed from the Carbon of a Dry Cell.

Several very simple home-made switches are illustrated in Figure 95.

The first one shown (A) has one contact, formed by driving a brass-headed tack through a small strip of copper or brass.

The movable arm is a strip of copper or brass, rolled up to form a handle at one end. The other end is pivoted with a brass screw. The brass screw passes through a small strip of copper or brass having a binding-post mounted on the end. A small copper washer should be placed between the movable arm and the copper strip to make the switch work more easily.

A somewhat similar switch is shown by B in the same illustration, only in this case a handle made from half of a spool is used, instead of rolling up the end of the arm.

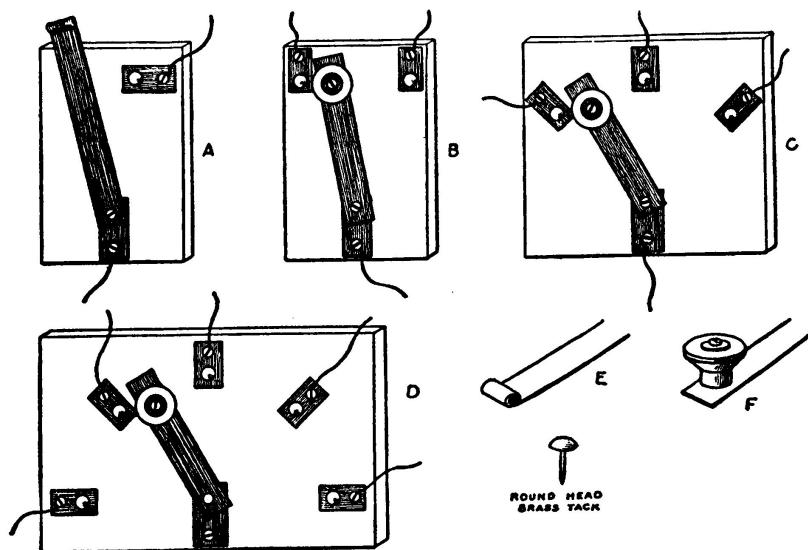

Fig. 95.—Simple Switches. A, Single-Point Switch. B, Two-Point Switch. C, Three-Point Switch. D, Five-Point Switch. E, Lever with End Rolled up to form Handle. F, Lever with Handle made from part of a Spool.

The other illustrations show how the same method of construction may be applied to make switches having more than one "point" or contact.

No dimensions have been given for constructing these switches, because it is doubtless easier for the young experimenter to use materials which he may have at hand, and construct a switch of his own proportions. Only one suggestion is necessary, and that is to bevel the under edges of the arm with a file, so that it will slip over the head of the brass tack more easily.

The switches shown in Figure 96 are capable of carrying heavier currents than those just described, and more nearly approach the type used on lighting and power switchboards.

The base may be made of wood, but preferably should be made of some insulating substance such as fiber or slate.

The patterns for the metal parts are shown in Figure 97. These are cut from heavy sheet-brass or sheet-copper, and then bent into shape with a pair of flat-nosed pliers.

The handle of the single-pole switch is driven on over the metal tongue.

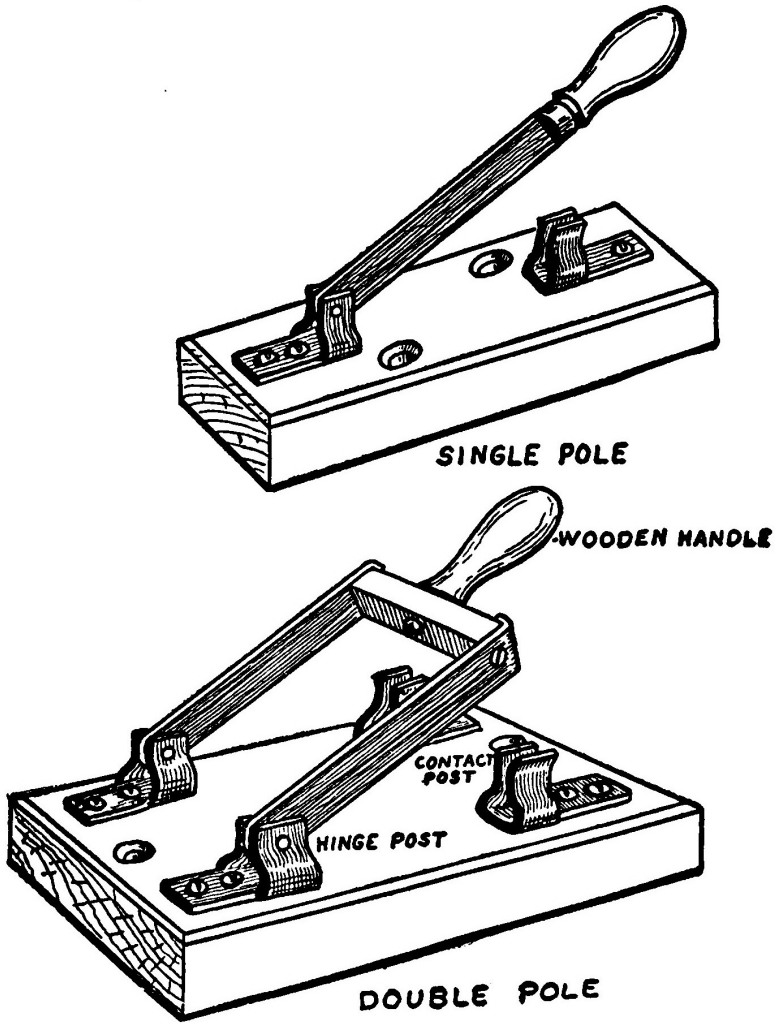

Fig. 96.—Knife Switches.

The double-pole switch is almost a duplicate of the single-pole type, but has two sets of levers and contacts, actuated by the handle, in place of one.

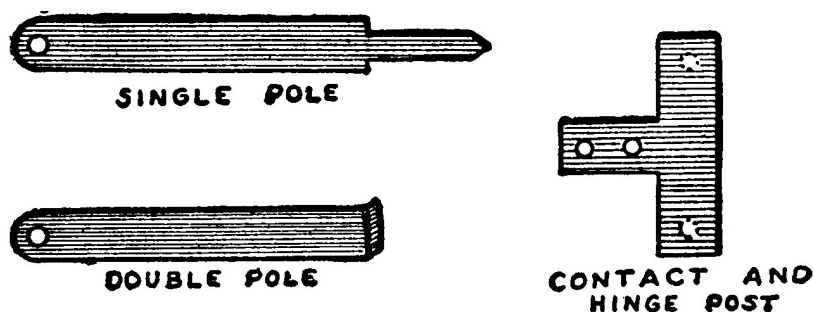

Fig. 97.—Metal Parts for the Knife Switches.

The ends of the blades to which the handle is connected are turned over at right angles and a hard-wood cross-bar fastened between the ends. The handle is fastened to the center of the cross-bar.

After the switch is assembled, bend the various parts until they "line up" that is, are in proper position in respect to each other, so that the blades will drop into the contacts without bringing pressure to bear on either one side or the other of the handle in order to force the blades into line.

Fuses

Fuses are used to prevent electrical instruments and wires from damage due to too much current flowing through. When an electric current passes through a resistance it produces *heat*.

A fuse is usually a short piece of lead or some alloy which melts at a low temperature, and which is inserted in the circuit so that the current must flow through it. If too much current flows through the fuse it will become hot and melt, because of its low melting-point, thus interrupting the circuit and shutting the current off until the cause which occasioned the surplus current to flow can be ascertained.

Fuses are rated according to the amount of current which is required to "blow" them out, and therefore are called 1, 3, 5, or 10 ampere fuses, as the case may be.

When a fuse burns out in a trolley car or in a light or power circuit, it is

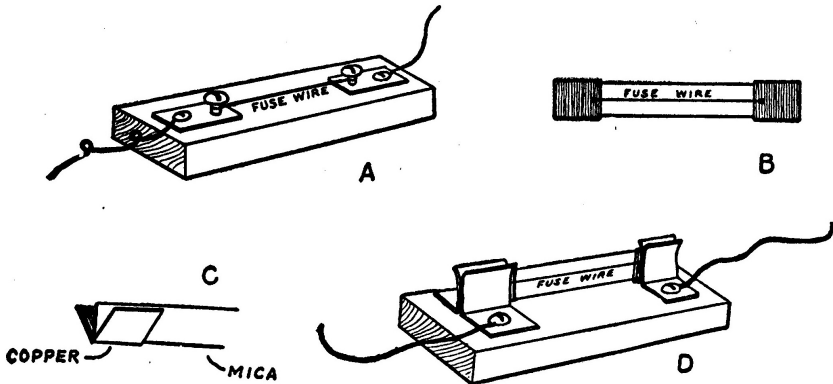

Fig. 98.—Simple Fuses. A, Fuse-Block with plain Wire Fuse. D, Fuse-Block with Mica Fuse in position.

because a greater amount of current is trying to pass than the circuit can safely carry. If a fuse were not placed in such a circuit so as to shut the current off before the danger point is reached, any electrical device might become "burned out," or in extreme cases, the wires become so hot as to cause a serious fire.

Figure 98 shows several simple forms of fuses which the experimenter may easily make to protect the batteries, etc., from short circuits.

The simplest possible fuse consists merely of a small piece of lead wire or a strip of thick tinfoil held between two binding-posts mounted upon a wooden block.

The same form of fuse may be made from a strip of mica about two and one-half inches long and one-half an inch wide.

A strip of thin sheet-copper is bent around the ends of the mica strip.

A piece of fuse wire is stretched between the two copper contacts and fastened to each with a drop of solder. Fuse wire of any desired ampere-carrying capacity can be obtained from most electrical supply houses.

Such a fuse is held in a mounting as shown by D. The contacts are made from sheet-copper or brass. They should spring together very tightly, so as to make perfect contact with the copper ends on the mica strip.

Lightning-Arresters

Lightning-arresters are used to protect all wires which run into a building from

outdoors, especially telegraph or telephone wires, so that static electricity due to lightning will not damage the instruments.

Lightning-arresters may be constructed in many ways and of different materials, but there are only two types for which the average experimenter will have any use.

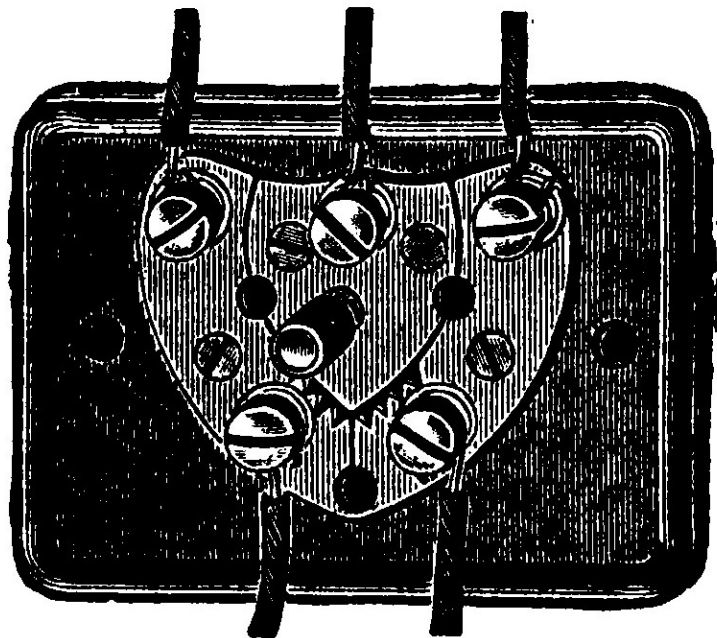

Fig. 99.—Lightning-Arrester and Ground-Wire Switch.

The arrester shown in Figure 99 is the type known as "lightning-arrester and ground-wire switch." It is used principally on telegraph lines.

It consists of three pieces of sheet-brass about one-sixteenth of an inch thick, and shaped as shown by *A*, *B*, and *C* in Figure 100.

The metal pieces are mounted on a wooden block with a narrow space of about one-thirty-second of an inch separating them.

The two outside pieces are each fitted with two binding-posts, and the center triangular-shaped piece is fitted with one post.

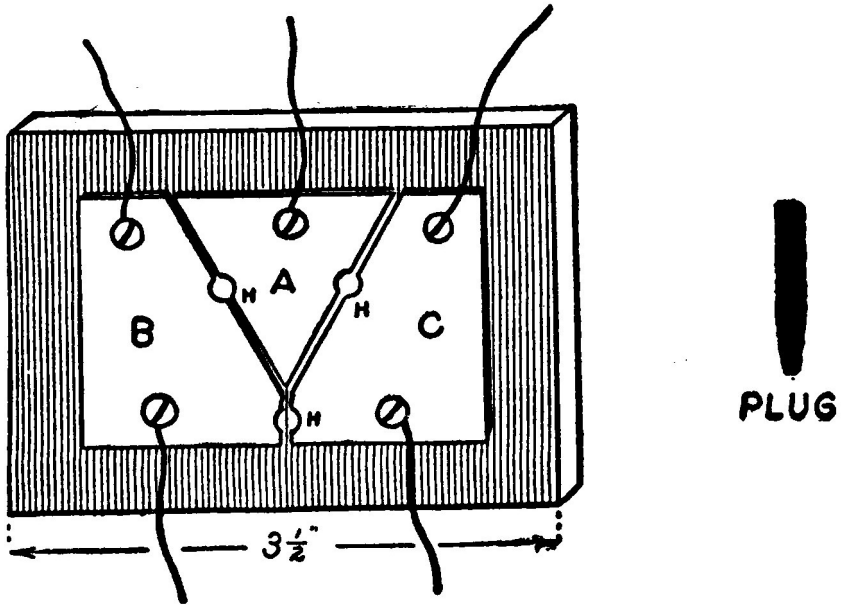

Fig. 100.—Home-made Lightning-Arrester.

A hole about one-eighth of an inch in diameter is bored between each of the metal pieces.

Make a tapered metal pin which can be placed tightly in the holes, and will make contact between the metal pieces.

The two outside line wires of the telegraph circuit are connected to the outside metal pieces *C* and *B*. *A* is connected to the earth or ground.

In case of a lightning storm, if the wires become charged, the small space between the metal plates will permit the charge to jump across and pass harmlessly into the ground.

If complete protection is desired, it is merely necessary to insert the plug in one of the holes, and thus "ground" either wire or short-circuit both of them.

The lightning-arrester shown in Figure 101 is designed for service on telephone wires. It is an ordinary fuse provided with an arrester in the shape of two carbon blocks about one inch square. The blocks rest on a copper strip, and are held in place by a spring-strip connected to *B*.

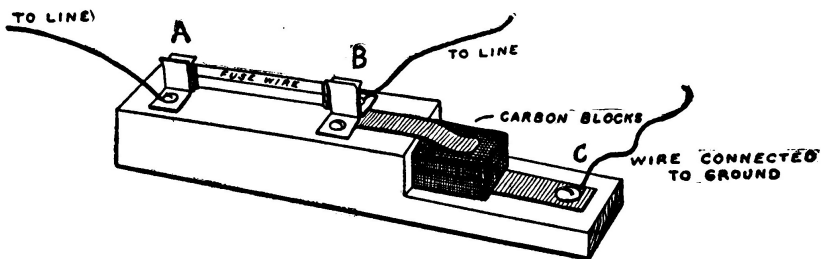

Fig. 101.—Lightning-Arrester for Telephone Wires.

The carbon blocks are separated by a piece of thin sheet-mica, of the same size as the blocks.

The post, *B*, is connected to one of the telephone-line wires near the point where it enters the building from outdoors. The post, *A*, is connected to the instrument; *C* is connected to the ground.

An arrester of this kind should be connected to each one of the telephone wires.

If the line wires should happen to come into contact with a power wire, there is danger of damage to the instruments, but if an arrester is connected in the circuit such an occurrence would be prevented by the blowing out of the fuse. If the lines become charged by lightning, the charge can easily pass over the edge of the mica between the two blocks and into the ground.

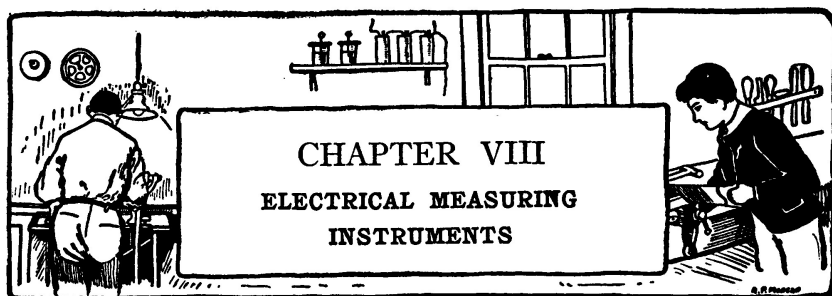

MENTS

An instrument designed to measure electromotive force (electrical pressure) is called a *voltmeter*. An instrument designed to measure volume of current is called an *ammeter*.

There are many forms of reliable meters for measuring current and voltage, but all are more or less expensive and out of the reach of an ordinary boy.

Some meters are more carefully made than a watch, and are provided with fine hair-springs and jeweled bearings, but all depend upon the same principle for their action, namely, the mutual effects produced between a magnetic needle and a coil of insulated wire carrying a current of electricity.

The little meters described in this chapter are simple and inexpensive but quite sensitive. Unlike a meter making use of a hair-spring, they will stand considerable rough handling, but of course should not be subjected to such treatment unnecessarily.

Two types of meters are described. Both operate on exactly the same principle, but one is more elaborate than the other.

A Simple Voltmeter and Ammeter

A base-board five inches long, two and one-half inches wide and one-half inch thick is cut out of hard wood. In its center, cut a slot three-eighths of an inch wide and one and one-half inches long, with the slot running lengthwise the board. Along each side of the slot glue two small wooden blocks one and one-half inches long, one-quarter of an inch thick, and one-half of an inch high.

When they are firmly in position, glue a strip of wood, two and one-half inches long, three-quarters of an inch wide and one-eighth inch thick to the top as shown by D in Figure 102.

Using these as a support, wind a horizontal coil composed of 200 feet of No. 36 B. & S. gauge silk-covered wire.

A needle is next made from a piece of watch-spring. It should be about one and one-quarter inches long, and one-eighth of an inch wide.

Straighten it out by bending, and then heat the center in a small alcohol flame until the center is red-hot, taking care to keep the ends as cool as possible.

The spring is mounted on a small steel shaft made by breaking up an ordinary sewing-needle. Make the piece one-half of an inch long. It must have very sharp points at both ends. The ends may be pointed by grinding.

Bore a small hole just large enough to receive the needle through the center of the spring. Insert the needle in the hole and fasten it in the center by two small circular pieces of wood which fit tightly on the needle. A little glue or sealing-

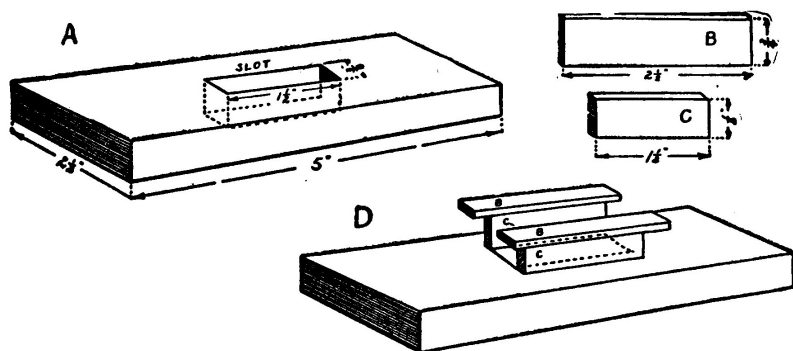

Fig. 102.—A, Base, showing Slot. B and C, Sides and Top of the Bobbin. D, Base and Bobbin in Position.

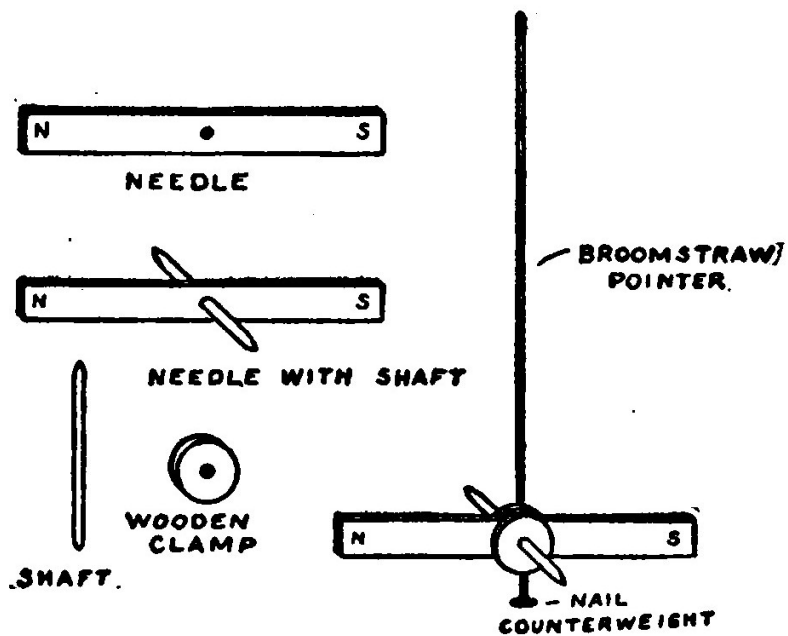

Fig. 103.—Arrangement of the Needle and Pointer.

wax will serve to help make everything firm.

The pointer is a piece of broom-straw, about three inches long. Bore a small hole in the top of one of the wooden clamps and insert the pointer in the hole, fastening it with a little glue. The pointer should be perfectly straight, and in a position at right angles to the spring.

Bore a small hole in the bottom of one of the wooden clamps and glue a small wire nail in the hole. The purpose of the nail is to serve as a counterweight and keep the pointer in a vertical position.

The spring should be magnetized by winding ten or twelve turns of magnet wire around one end and connecting it with a battery for a moment.

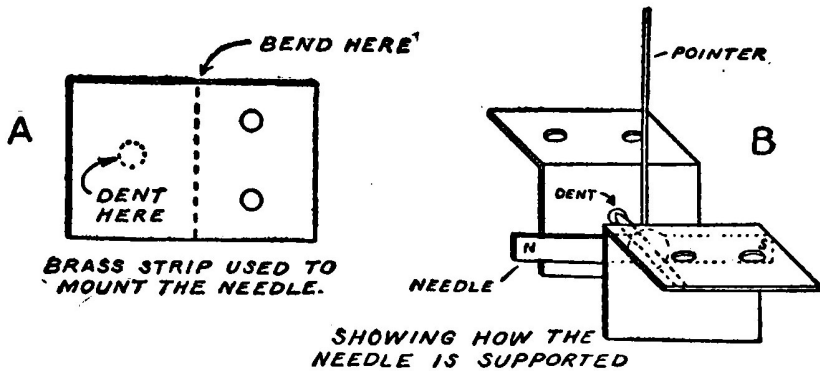

Fig. 104.—A, Bearings. B, How the Needle is mounted.

The needle is mounted in two small pieces of thin sheet-brass, one inch long and one-half inch wide. Bend each strip at right angles in the middle, and at one-quarter of an inch from one end make a small dent by means of a pointed nail and a hammer.

The strips are now slipped down in the center of the slot in the coil with the dents inside of the coil and exactly opposite one another. After the exact position is found, they may be fastened into position by two very small screws.

The sharp-pointed sewing-needle, together with the magnetized spring, pointer, and counterweight, should slip down into the dents made in the strips and swing freely there. It may require a little filing and bending, but the work should be done patiently, because the proper working of the meter will depend upon having the needle swing freely and easily in its place.

Fasten an upright board, four inches wide and one-quarter of an inch thick, to the base-board, back of the bobbin.

Attach a piece of thick cardboard to the upright by means of small blocks, in such a position that the pointer swings very close to it but does not touch it.

The meter is now complete, except for marking or calibrating the scale. The method of accomplishing this will be described farther on.

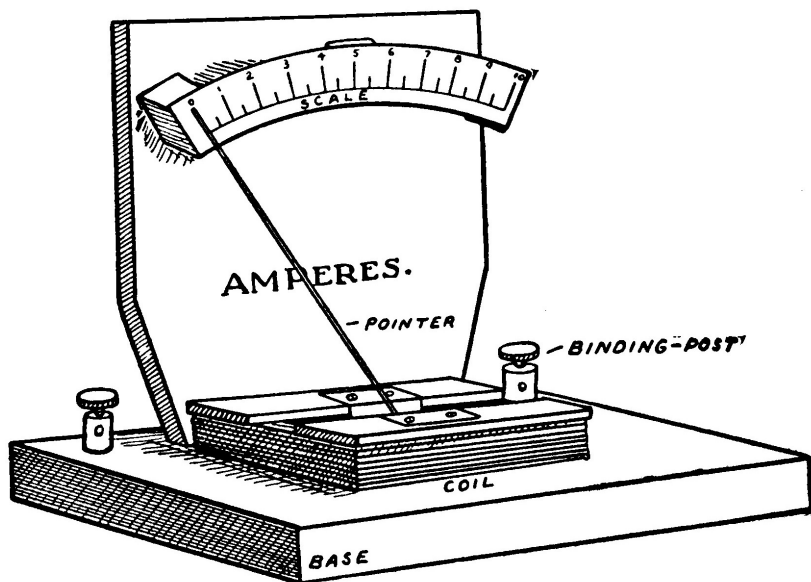

Fig. 105.—The Completed Meter.

If the meter is wound with No. 36 B. & S. gauge wire it is a voltmeter for measuring voltage. If it is wound with No. 16 B. & S. gauge wire it will constitute an ammeter for measuring amperes.

A Portable Voltmeter and Ammeter

The bobbin upon which the wire is wound is illustrated in Figure 106. The wood is the Spanish cedar, of which cigar boxes are made. It should be one-eighth of an inch thick, and can be easily worked with a pocket-knife. In laying out the work, scratch the lines on the wood with the point of a darning-needle. Pencil lines are too thick to permit of accuracy in small work. The bobbin when finished must

be perfectly true and square.

The dimensions are best understood from the illustrations. In putting the bobbin together, do not use any nails. Use strong glue only.

Two bobbins are required, one for the ammeter and one for the voltmeter. After completing the bobbins, sandpaper them and coat them with shellac.

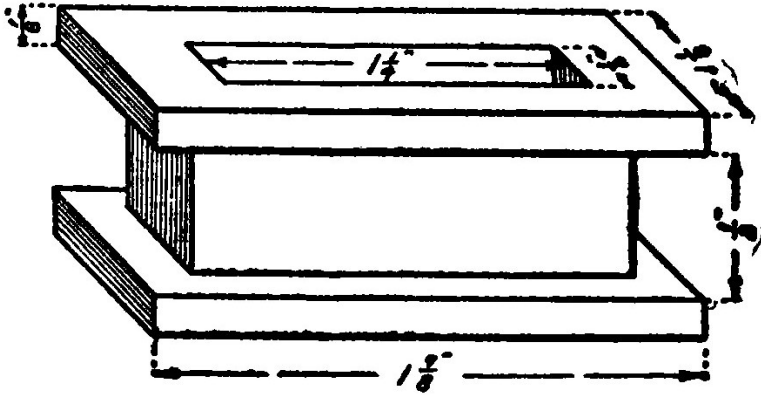

Fig. 106.—Details of the Bobbin.

The bobbin for the ammeter is wound with No. 14 B. & S. double-cotton-covered magnet wire. The voltmeter requires No. 40 B. & S. silk-covered wire. In both cases the wire should be wound carefully in smooth, even layers. A small hole is bored in the flange through which to pass the end of the wire when starting the first layer. After finishing the winding, about six inches of wire should be left at both ends to make connection with the terminals. The whole winding is then given a coat of shellac. A strip of passe-partout tape, one-half of an inch wide wound over the wire around the bobbin will not only protect the wire from injury, but also give the bobbin a very neat appearance.

The armature is a piece of soft steel one inch long, one-eighth of an inch thick and three-eighths wide. A one-eighth-inch hole is bored one-sixteenth of an inch above the center for the reception of the shaft. The center of gravity is thus thrown below the center of the mass of the armature, and the pointer will always return to zero if the instrument is level.

The shaft is a piece of one-eighth-inch Bessemer steel rod, seven-sixteenths of an inch long. The ends are filed to a sharp knife-edge on the under side, as

indicated in the figure.

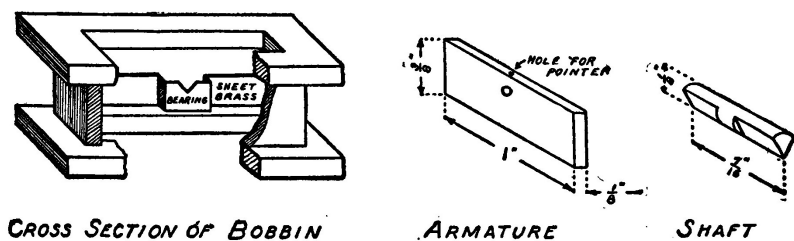

Fig. 107.—The Bobbin partly cut away so as to show the Bearing. Details of the Armature and Shaft.

A one-sixteenth-inch hole is bored in the top of the armature to receive the lower end of the pointer, which is a piece of No. 16 aluminum wire, four and one-half inches long.

After the holes have been bored, the armature is tempered so that it will retain its magnetism. It is heated to a bright red heat and dropped into a basin of strong salt water. The armature is then magnetized by rubbing one end against the pole of a strong magnet.

The bearings are formed by two strips of thin sheet-brass, three-sixteenths of an inch wide, and one and one-quarter inches long, bent and glued to the sides of the bobbin.

In the illustration, part of the bobbin is represented as cut away. The center of the bearing is bent out so that the end of the shaft will not come in contact with the sides of the bobbin. The top of the center is notched with a file to form a socket for the knife-edges of the shaft.

The bobbin is glued to the center of a wooden base, seven inches long, four inches wide and three-quarters of an inch thick. The terminals of the coil lead down through two small holes in the base and thence to two large binding-posts. The wires are inlaid on the under side of the base, i.e., they pass from the holes to the binding-posts through two grooves. This precaution avoids the possibility of their becoming short-circuited or broken.

The case is formed of two sides, a back and top of one-half-inch wood. It is six inches high, four inches wide, and two inches deep. A glass front slides in two shallow grooves cut in the wooden sides, one-eighth of an inch from the front.

The case is held down to the base by four round-headed brass screws, which

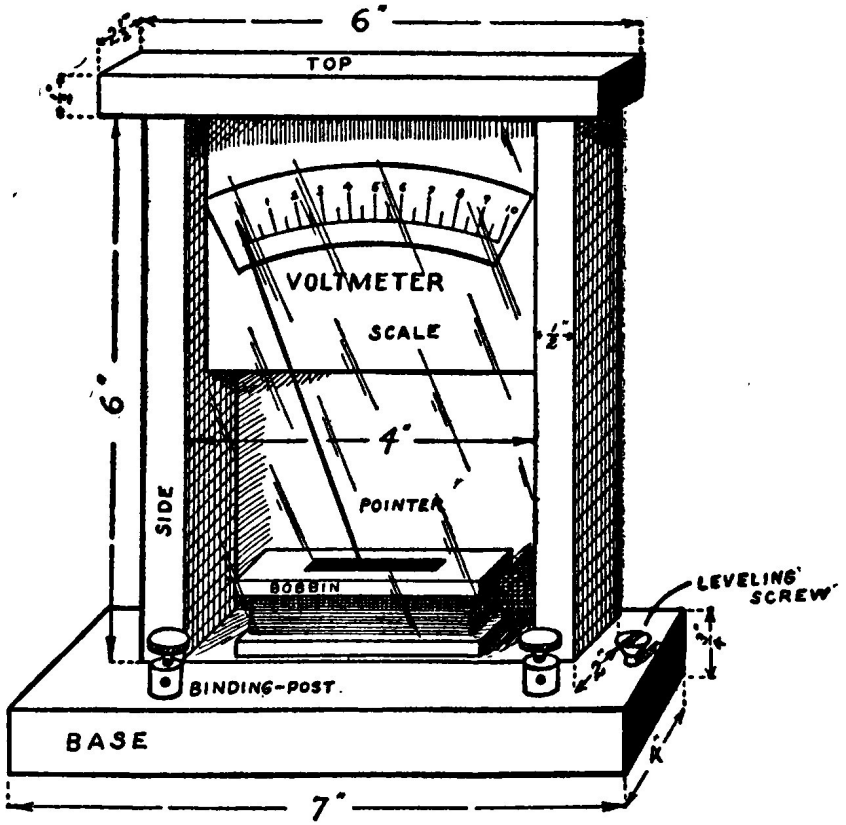

Fig. 108.—Completed Voltmeter.

pass through the base into the sides. It is then easily removable in case it ever becomes necessary to repair or adjust the instrument.

The meter and case, as illustrated in Figure 108, are intended for portable use and are so constructed that they will stand up. A small brass screw, long enough to pass all the way through the base, serves to level the instrument. If a little brass strip is placed in the slot in the screw-head and soldered so as to form what is known as a "winged screw," the adjustment may be made with the fingers and without the aid of a screw-driver.

Where the instrument is intended for mounting upon a switch-board, it can be given a much better appearance by fitting with a smaller base, similar in size and shape to the top. The binding-posts are then mounted in the center of the sides.

To calibrate the meters properly, they are compared with some standard. The scale is formed by a piece of white cardboard glued by two small blocks on the inside of the case. The various values are marked with a pen and ink. The glass front, therefore, cannot be put in place until they are located.

The zero value on the meters will normally be in the center of the scale. When a current is passed through the bobbin, the armature tends to swing around at right angles to the turns of wire. But since the armature is pivoted above the center of the mass, when it swings, the center of gravity is displaced and exerts a pull in opposition to that of the bobbin, and the amount of swing indicated by the pointer will be greater as the current is stronger. The pointer will swing either to the right or the left, depending upon the direction in which the current passes through the bobbin. The pointer of the instrument illustrated in Figure 108 is at zero when at the extreme left of the scale. The pointer is bent to the left, so that the current will be registered when passing through the meter only in one direction, but the scale will have a greater range of values. It will also be necessary to cut a small groove in the base of the instrument in this case so that the armature will have plenty of room in which to swing.

When calibrating the ammeter, it is placed in series with the standard meter, a set of strong batteries, and a rheostat. The rheostat is adjusted so that various current readings are obtained. The corresponding positions of the pointer on the meter being calibrated are then located for each value.

The voltmeters must be placed in parallel, or shunt with each other, and in series with several battery cells. A switch is arranged so that the voltage of a varying number of cells may be passed through the meters. To secure fractional values of a volt, the rheostat is placed in shunt with the first cell of the battery. Then, by adjusting both the switch and the rheostat, any voltage within the maximum range of the battery may be secured.

This means of regulating voltage is a common one, and of much use in

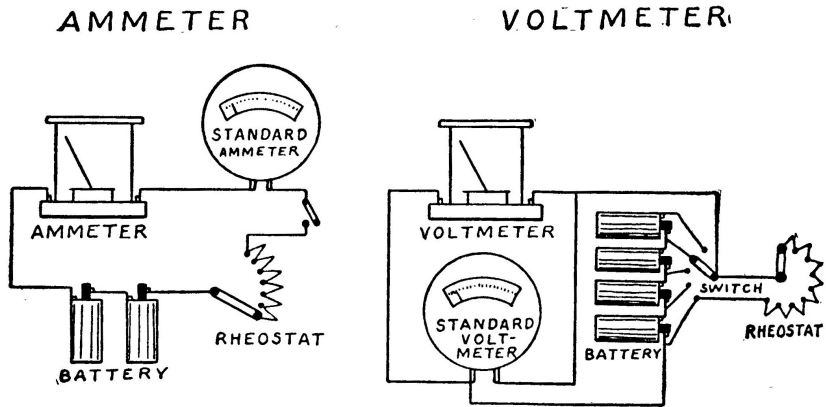

Fig. 109.—Circuits for Calibrating the Ammeter and Voltmeter.

wireless telegraph circuits, as will be explained later.

When using the meters, it is always necessary that the ammeter shall be in series and the voltmeter in parallel or in shunt with the circuit.

Galvanoscopes and Galvanometers

In the first part of Chapter V it was explained that several turns of wire surrounding a compass-needle would cause the needle to move and show a deflection if a current of electricity were sent through the coil.

Such an instrument is called a *galvanoscope* and may be used for detecting very feeble currents. A galvanoscope becomes a *galvanometer* by providing it with a scale so that the deflection may be measured.

A galvanometer is really, in principle, an ammeter the scale of which has not been calibrated to read in amperes.

A very simple galvanoscope may be made by winding fifty turns of No. 36 B. & S. gauge single-silk-covered wire around an ordinary pocket compass. The compass may be set in a block of wood, and the wood provided with binding-posts so that connections are easily made.

Another variety of the same instrument is shown in Figure 111.

Wind about twenty-five turns of No. 30 B. & S. gauge cotton-covered wire around the lower end of a glass tumbler. Leave about six inches of each end free for terminals, and then, after slipping the coil from the glass, tie the wire with

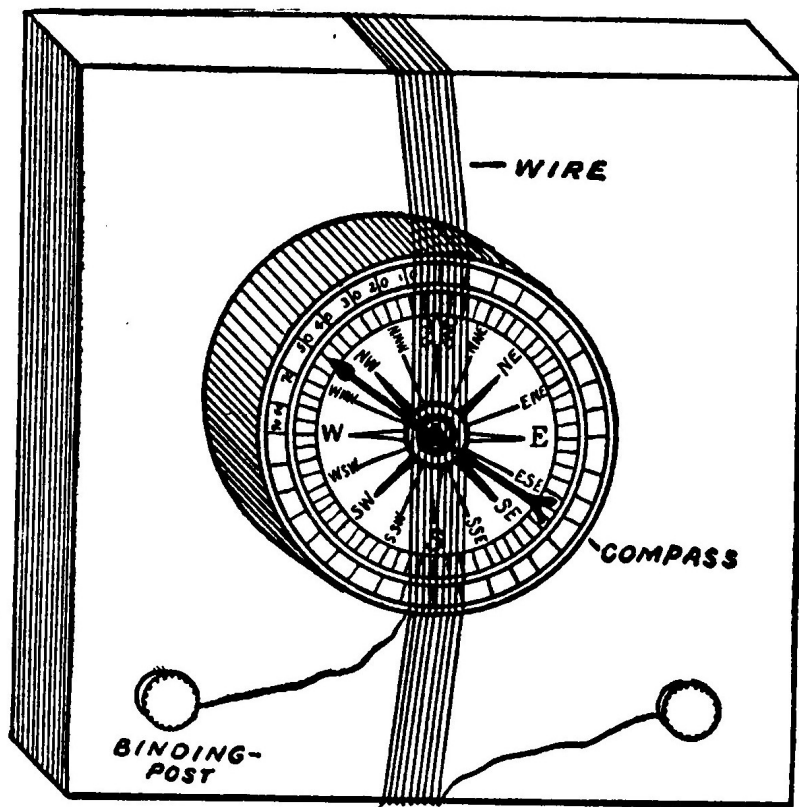

Fig. 110.—Simple Compass Galvanoscope.

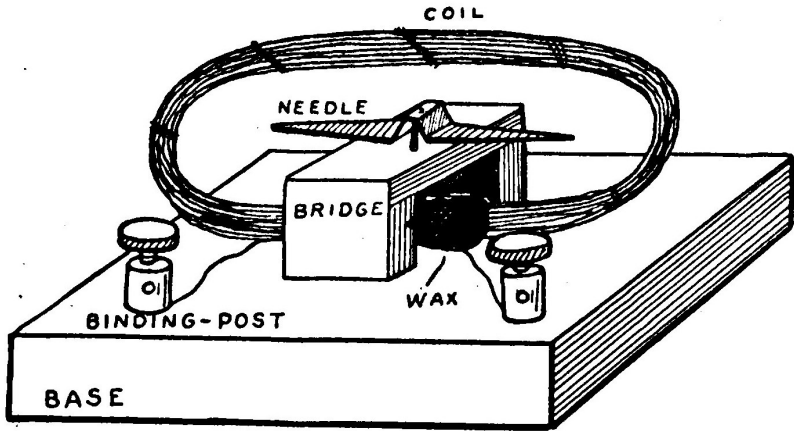

Fig. 111.—Galvanoscope.

thread in several places so that it will not unwind. Press two sides of the coil together so as to flatten it, and then attach it to a block of wood with some hot sealing-wax.

Make a little wooden bridge as shown in Figure 111, and mount a compass-needle on it in the center. The compass-needle may be made out of a piece of spring-steel in the manner already described in Chapter I.

Mount two binding-posts to the corners of the block, and connect the ends of the wire coil to them. Turn the block so that the needle points North and South and parallel to the coil of wire.

If a battery is connected to the binding-posts, the needle will fly around to a position at right angles to that which it first occupied.

An astatic galvanoscope is one having two needles with their poles in opposite directions. The word "astatic" means having no directive magnetic tendency. If the needles of an astatic pair are separated and pivoted separately, they will each point to North and South in the ordinary manner. But when connected together with the poles arranged in opposite directions they neutralize each other.

An astatic needle requires but very little current in order to turn it either one way or the other, and for this reason an astatic galvanoscope is usually very sensitive.

A simple instrument of this sort may be made by winding about fifty turns of No. 30-36 B. & S. gauge single-silk or cotton-insulated wire into a coil around

a glass tumbler. After removing the coil from the glass, shape it into the form of an ellipse and fasten it to a small base-board.

Separate the strands of wire at the top of the coil so that they are divided into two groups.

Make a bridge or standard in the shape of an inverted U out of thin wooden strips and fasten it to the block.

The needles are ordinary sewing-needles which have been magnetized and shoved through a small carrier-bar, made from a strip of cardboard, with their poles opposite one another, as shown in the illustration.

They may be held in place in the cardboard strip by a small drop of sealing-wax.

A small hole is punched in the top of the carrier, through which to pass the end of a thread. The upper end of the thread passes through a hole in the bridge and is tied to a small screw-eye in the center of the upper side of the bridge.

The carrier-bar is passed through the space where the coil is split at the top. The lower needle should hang in the center of the coil. The upper needle should be above and outside the coil.

The terminals of the coil are connected to two binding-posts mounted on the base-block.

Owing to the fact that this galvanoscope is fitted with an astatic needle, the instrument does not have to be turned so that the coil may face North and South. The slightest current of electricity passing into the coil will instantly affect the needles.

An astatic galvanometer for the detection of exceedingly weak currents and for use in connection with a "Wheatstone bridge" for measuring resistance, as described farther on, will form a valuable addition to the laboratory of the boy electrician.

Make two small bobbins similar to those already described in connection with the volt and ammeter, but twice as long, as shown in Figure 114.

Wind each of the bobbins in the same direction with No. 36 silk-covered or cotton-covered wire, leaving about six inches free at the ends for connection to the binding-posts.

Fasten each of the bobbins to the base-board with glue. Do not nail or screw them in position, because the presence of nails or screws may impair the sensitiveness of the instrument. In mounting the bobbins, leave about one-sixteenth of an inch of space between the inside flanges, through which the needle may pass.

Connect the coils wound on the bobbins so that the end of the outside layer of the first coil is connected to the inside layer of the other coil. This arrangement is so that the current will travel through the windings in the same continuous

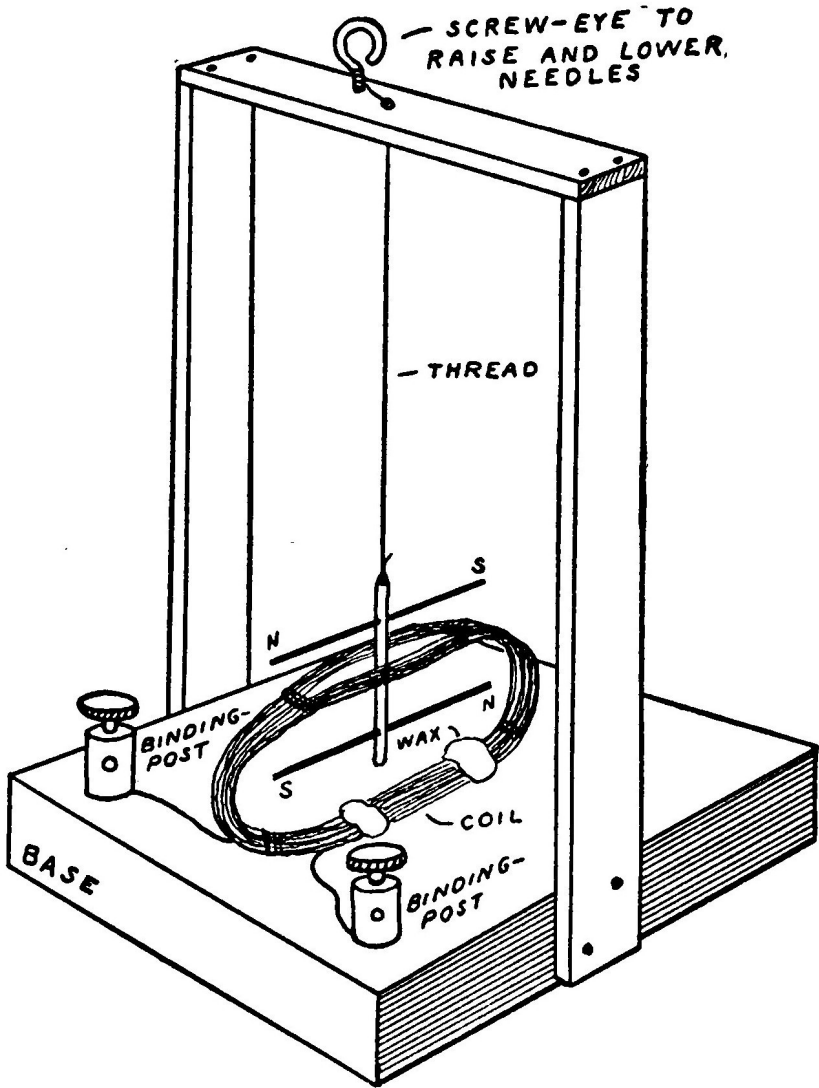

Fig. 112.—Astatic Galvanoscope.

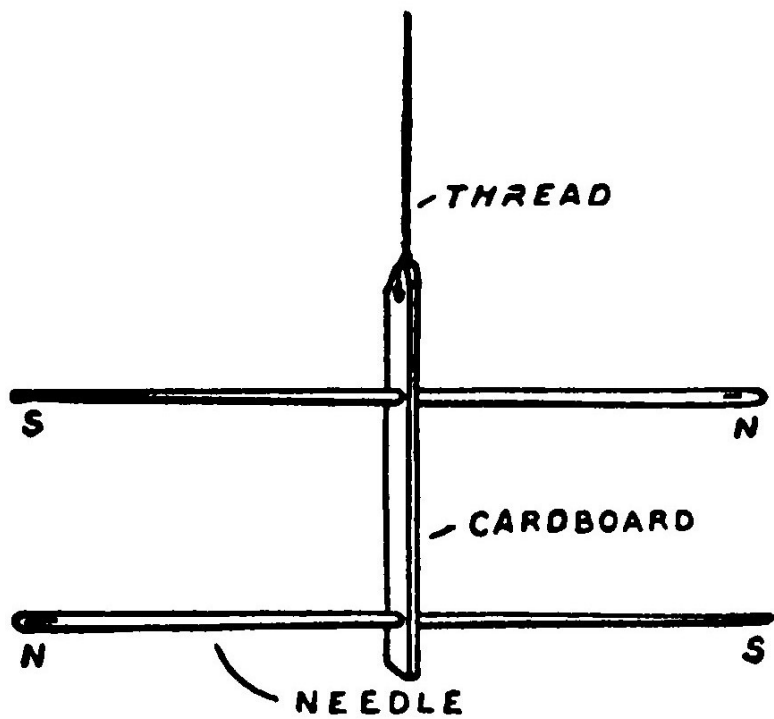

Fig. 113.—Astatic Needles.

direction, exactly the same as though the bobbin were one continuous spool.

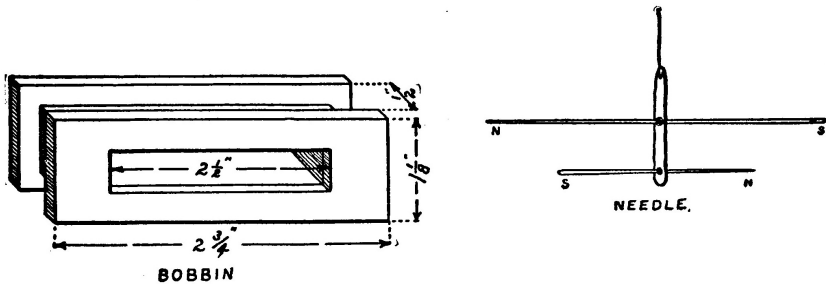

Fig. 114.—Bobbin for Astatic Galvanometer.

Magnetize two small sewing-needles and mount them in a paper stirrup made from good, strong paper, as shown in Figure 114. Take care that the poles are reversed so that the north pole of one magnet will be on the same side of the stirrup as the south pole of the other. They may be fastened securely by a drop of shellac or melted sealing-wax.

Cut out a cardboard disk and divide it into degrees as in Figure 115. Glue the disk to the top of the bobbins. A small slot should be cut in the disk so that it will pass the lower needle.

A wooden post should be glued to the back of the base. To the top of this post is fastened an arm from which are suspended the magnetic needles.

A fine fiber for suspending the needle may be secured by unraveling a piece of embroidery silk.

The upper end of the fiber is tied to a small hook in the end of the arm. The wire hook may be twisted so that the needles may be brought to zero on the scale. Zero should lie on a line parallel to the two coils.

The fiber used for suspending the needles should be as fine as possible. The finer the fiber is, the more sensitive will the instrument be.

The lower needle should swing inside of the two coils, and the upper needle above the disk.

How to Make a Wheatstone Bridge

The amateur experimenter will find many occasions when it is desirable to know the resistance of some of his electrical apparatus. Telephone receivers, telegraph relays, etc., are all graded according to their resistance in ohms. The measure-

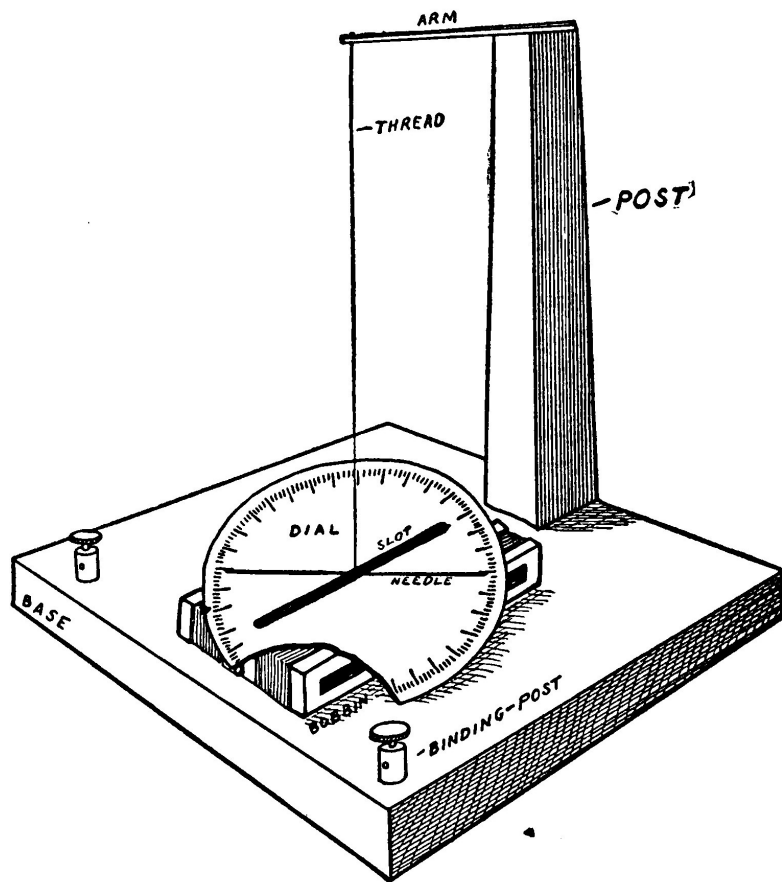

Fig. 115.—Completed Astatic Galvanometer.

ment of resistance in any electrical instrument or circuit is usually accomplished by comparing its resistance with that of some known circuit, such as a coil of wire which has been previously tested.

The simplest method of measuring resistance is by means of a device known as the Wheatstone bridge. This instrument is very simple but at the same time is remarkably sensitive if properly made. A Wheatstone bridge is shown in Figure 116.

The base is a piece of well-seasoned hard wood, thirty inches long, six inches wide, and three-quarters of an inch thick.

Secure a long strip of No. 18 B. & S. gauge sheet-copper, one inch wide, and cut it into three pieces, making two of the pieces three inches long, and the other piece twenty-three and one-half inches long.

Mount the copper strips on the base, as shown, being very careful to make the distance between the inside edges of the end-pieces just twenty-five inches. The strips should be fastened to the base with small round-headed brass screws. Mount two binding-posts on each of the short strips in the positions shown in the illustration, and three on the long strip. These binding-posts should pass through the base and make firm contact with the strips.

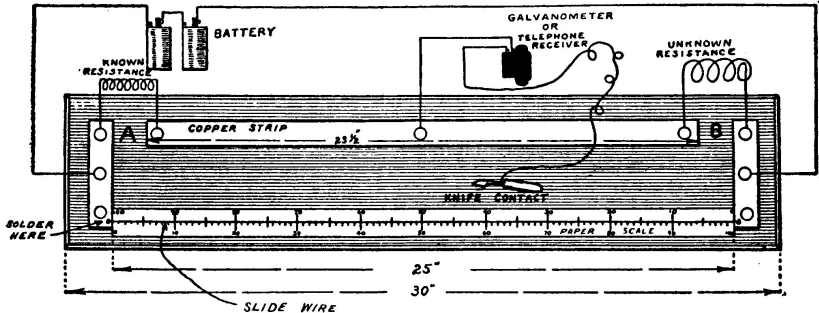

Fig. 116.—Wheatstone Bridge.

Then make a paper scale twenty-five inches long, and divide it into one hundred equal divisions one-quarter of an inch long. Mark every fifth division with a slightly longer line, and every tenth division with a double-length line.

Start at one end and number every ten divisions, then start at the other end and number them back, so that the scale reads 0, 10, 20, 30, 40, 50, 60, 70, 80, 90, 100, from right to left at the top and 0, 10, 20, 30, 40, 50, 60, 70, 80, 90, 100, from

left to right at the bottom.

Solder a piece of No. 30 B. & S. gauge German-silver wire to one of the short copper strips opposite the end of the scale, and then stretch it tightly across the scale and solder it to the strip at the other end.

Make a knife-contact by flattening a piece of heavy copper wire as shown in Figure 117. Solder a piece of flexible wire, such as "lamp cord," at the other end. It is well to fit the contact with a small wooden handle, made by boring out a piece of dowel.

The instrument is now practically complete.

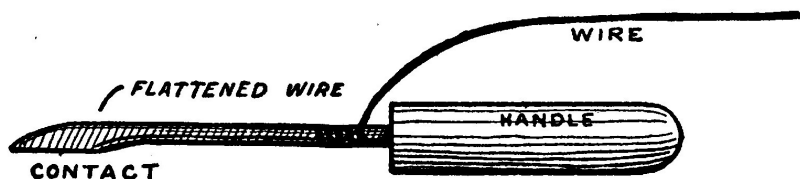

Fig. 117.—Knife-Contact.

In order to use the Wheatstone bridge, it is necessary to have a set of resistances of known value. The resistance of any unknown circuit or piece of apparatus is found by comparing it with one of the known coils. It is just like going to a store and buying a pound of sugar. The grocer weighs out the sugar by balancing it on the scales with an iron weight of known value, and taking it for granted that the weight is correct, we would say that we have one, five, or ten pounds of sugar, as the case may be.

The Wheatstone bridge might be called a pair of "electrical scales" for weighing resistance by comparing an unknown coil with one which we know has a certain value.

The next step is to make up some standard resistance coils. Secure some No. 32 B. & S. gauge single-cotton-covered wire from an electrical dealer and cut into the following lengths, laying it straight on the floor but using care not to pull or stretch it.

- 1/2 ohm coil—3 feet 1/2 inch
- 1 ohm coil—6 feet 1 1/4 inches
- 2 ohm coil—12 feet 2 1/2 inches
- 5 ohm coil—30 feet 6 1/4 inches
- 10 ohm coil—61 feet

20 ohm coil—122 feet
 30 ohm coil—183 feet
 50 ohm coil—305 feet

These lengths of wire are then wrapped on the spools in the following manner.

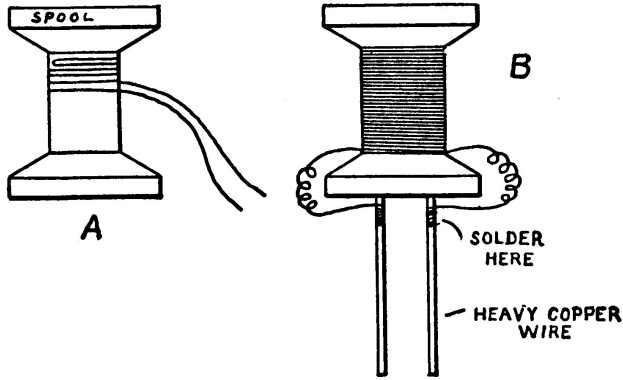

Fig. 118.—Resistance-Coil. A shows how the Wire is doubled and wound on the Spool. B is the completed Coil.

This method of winding is known as the non-inductive method, because the windings do not generate a magnetic field, which might affect the galvanometer needle used in connection with the Wheatstone bridge as described later on.

Each length of wire should be doubled exactly in the middle, then wrapped on the spools like a single wire, the two ends being left free for soldering to the terminals as shown in Figure 118, B.

The spools may be the ordinary reels upon which cotton and sewing-silk are wrapped.

The terminals of the spools are pieces of stout copper wire, No. 12 or No. 14 B. & S. gauge. Two pieces of wire about three inches long are driven into holes bored in the ends of each spool. A small drop of solder is used permanently to secure the ends of the coil to each of the heavy wire terminals.

The spools are then dipped into a pan of molten paraffin and boiled until the air bubbles cease to rise.

The spools should be marked 1, 2, 10, 20, 30, and 50, according to the amount of wire each one contains as indicated in the table above.

How to Use a Wheatstone Bridge for Measuring Resistance

The instrument is connected as in Figure 116.

The unknown resistance or device to be measured is connected across the gap at *B*. One of the standard known coils is connected across the gap at *A*. A sensitive galvanometer or a telephone receiver and two cells of battery are also connected as shown.

If a telephone receiver is used, place it to the ear. If a galvanometer is used instead, watch the needle carefully. Then move the sharp edge of the knife-contact over the scale along the German-silver "slide wire" until a point is reached when there is no deflection of the needle or no sound in the telephone receiver.

If this point lies very far on one side or the other of the center division on the scale, substitute the next higher or lower known resistance spool until the point falls as near as possible to the center of the scale.

When this point is found, note the reading on the scale carefully. Now comes the hardest part. Almost all my readers have no doubt progressed far enough in arithmetic to be able to carry on the following simple calculation in proportion which must be made in order to find out the resistance of the unknown coil.

The unknown resistance, connected to *B*, bears the same ratio to the known coil, at *A*, that the number of divisions between the knife-contact and the right-hand end of the scale (lower row of figures) bears to the number of divisions between the knife-edge and the left-hand end of the scale (upper row of figures).

We will suppose that a 5-ohm coil was used at *A* in a test, and the needle of the galvanometer stopped swinging when the knife-contact rested on the 60th division from the left-hand end, or on the 40th from the right. Then, in order to find the value of the unknown resistance at *B*, it is simply necessary to multiply the standard resistance at *A* by the number of left-hand divisions and divide the product by the number of right-hand divisions. The answer will be the resistance of *B* in ohms.

The calculation in this case would be as follows:

$$5 \times 40 = 200$$

$$200/60 = 3.33 \text{ ohms}$$

3.33 ohms is the resistance of *B*.

This explanation may seem very long and complex, but if you will study it carefully you will find it to be very simple. When once you master it, you will be

enabled to make many measurements of resistance which will add greatly to the interest and value of your experiments.

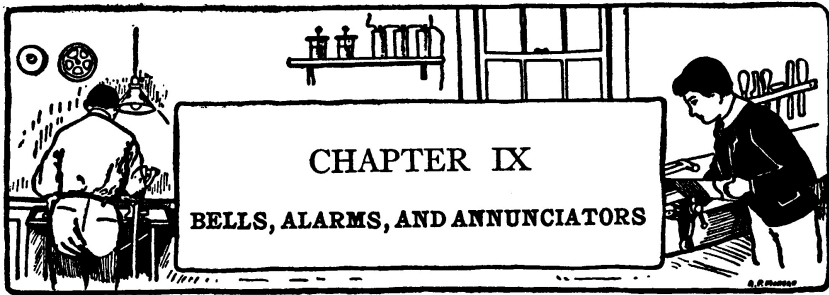

CHAPTER IX BELLS, ALARMS, AND ANNUNCIATORS

An electric bell may be bought almost anywhere for twenty-five cents, and from the standpoint of economy it does not pay to build one.

A bell is not a hard thing to construct, and the time and money spent will be amply repaid by the more intimate knowledge of this useful piece of apparatus which will be gained by constructing it.

The base is four inches wide and five and one-half inches long.

The magnets consist of two machine bolts, wound with No. 22 cotton-covered magnet wire. Fiber ends are fitted on the bolts to hold the wire in place.

The wire is wound on each of the magnets separately. Cover the cores with two or three layers of paper before winding on the wire. The ends of the wire are led through holes in the core ends. The ends of the bolts are passed through the yoke, and the nuts applied to hold them in place.

The magnets are clamped down to the bell-base by means of a hard-wood strip having a screw passed through it between the magnets into the base.

The armature of the bell is shown in Figure 120. It is made of a piece of iron having a steel spring riveted to it, as illustrated. The armature is fastened to a small block mounted on the lower left-hand corner of the base.

A second block with a contact-point made from an ordinary brass screw by filing the end into the shape shown in the illustration, is mounted on the base so that it is opposite the end of the contact-spring fastened to the armature. The gong may be secured from an old bell or alarm clock. It is mounted on the upper part of the base in such a position that the hammer will strike it on its lower edge.

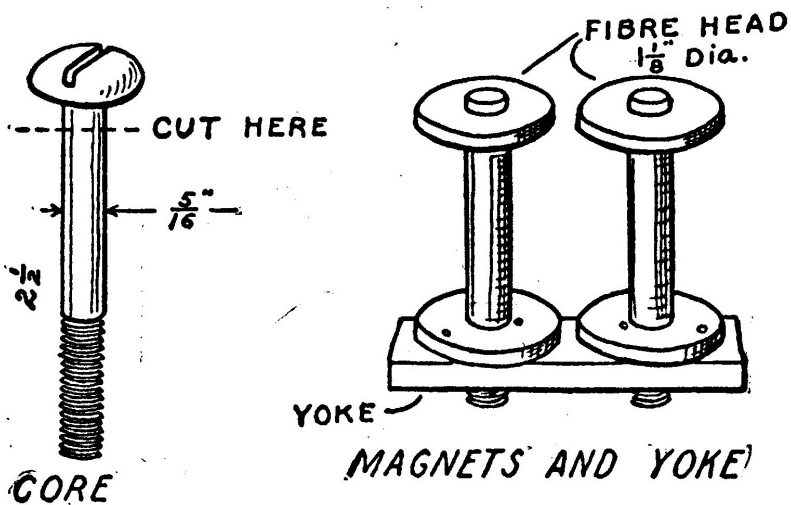

Fig. 119.—Details of the Magnet Spools, and Yoke for an Electric Bell.

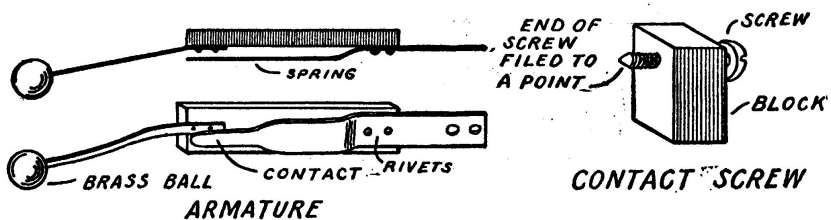

Fig. 120.—Details of the Armature, and Contact Screw.

The instrument is connected as shown in Figure 121. One terminal of the magnets is connected to the contact-screw. The other end is connected to the binding-post. A second binding-post is connected to the armature.

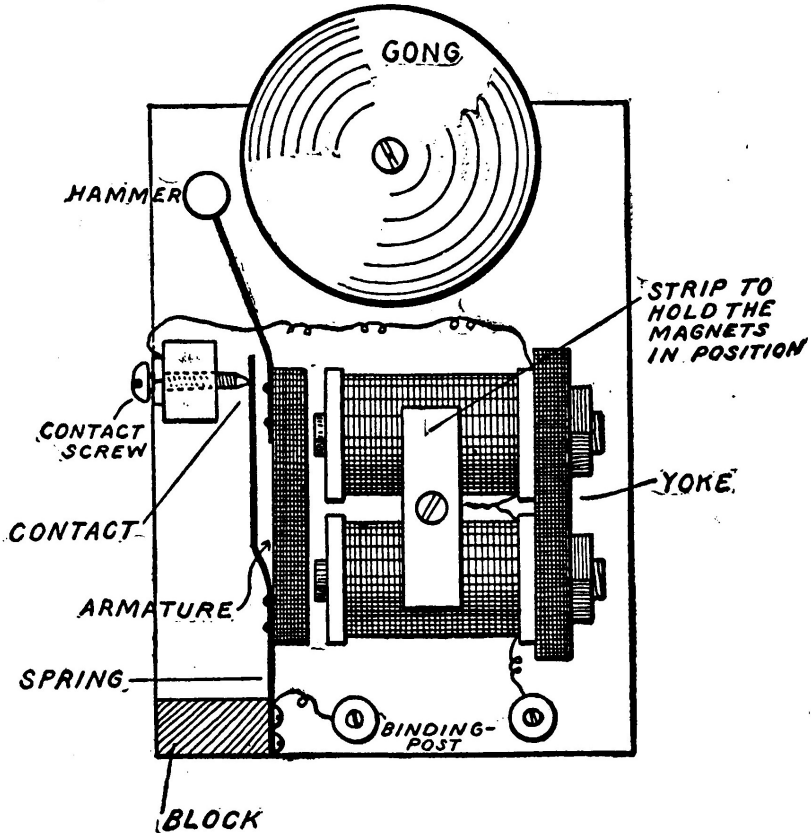

Fig. 121.—The Completed Bell.

The armature spring should be bent so that the armature is pushed over against the contact.

If a battery is connected to the bell, the electromagnets will pull the armature and cause the hammer to strike the gong. As soon as the armature has moved a short distance, the spring will move away from the contact and break the circuit. The magnets cease pulling as soon as the current is cut off and the

armature spring then causes the armature to move back and touch the contact. As soon as the contact is made, the armature is drawn in again and the process is repeated.

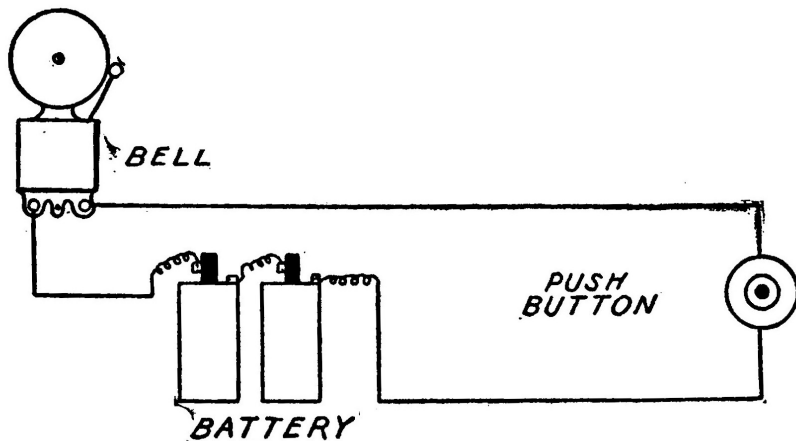

Fig. 122.—Diagram showing how to connect a Bell, Battery, and Push-Button.

A little experimenting with the bell will soon enable one to find its best adjustment. Figure 122 shows how to connect a bell to a battery and a push-button. A push-button is simply a small switch which closes the circuit when pressed. Do not make the armature spring too weak, or the hammer will move very slowly and with very little life. Each time that the armature moves toward the magnets, it should barely touch the iron cores before the ball strikes the bell.

After you get the bell in good working order, it is well to make a small box to serve as a cover for the working parts of the instrument, leaving only the gong exposed.

It is sometimes desirable to arrange two bells and two push-buttons, so that a return signal can be sent. In that case the circuit shown in Figure 124 may be employed. It is then possible for the person answering the bell to indicate that he has heard the call by pushing the second button. For instance, one push-button and bell might be located on the top floor of a house and the other bell and button in the basement. A person in the basement wishing to call another on the top floor would push the button. The person answering could return the signal by pushing the button on the top floor and cause the bell in the basement to ring.

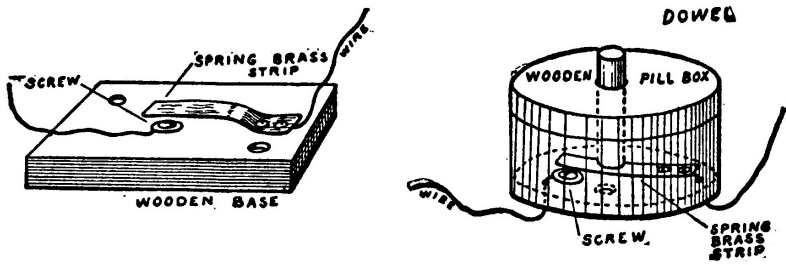

Fig. 123.—Two Simple Push-Buttons.

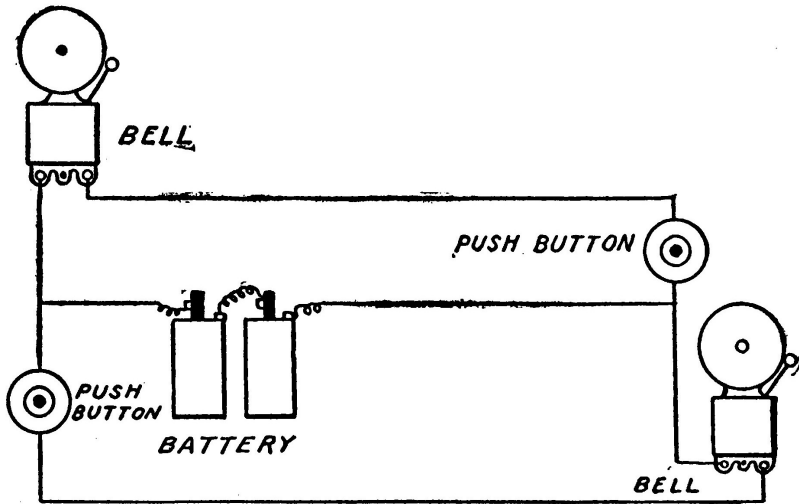

Fig. 124.—Diagram showing how to arrange a Bell System of Return Signals.

A Burglar Alarm

A simple method of making an efficient burglar alarm is shown in Figure 125. The base is a piece of wood about five by six inches, and half an inch thick. A small brass strip, *A*, is fastened to the base by means of two round-headed wood screws and the ends turned up at right angles. The lever, *B*, is also a strip of brass. One end is bent out, so as to clear the strip and the screws that are under it. The lever is pivoted in the middle with a screw and a washer. A small hole, *D*, is bored in the lower end through which a spring and a string are passed. The other end of the spring is fastened under a screw and washer, *C*.

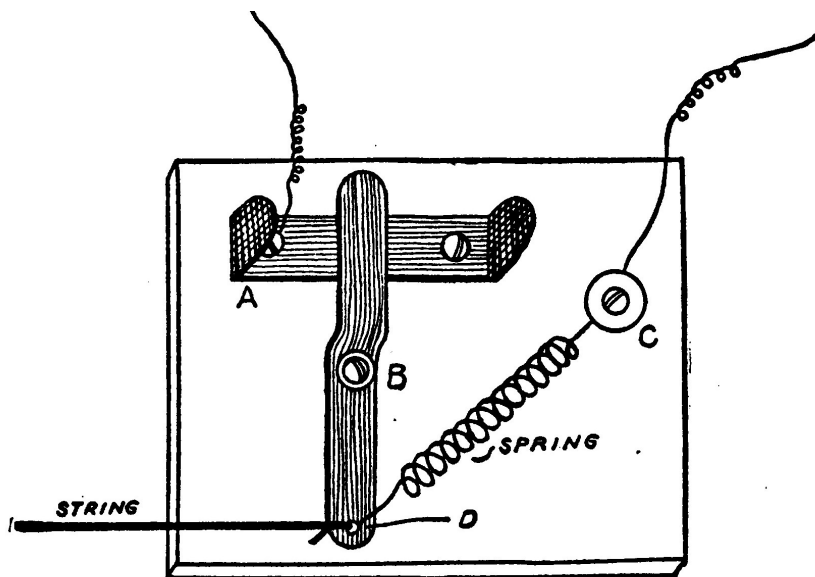

Fig. 125.—Burglar-Alarm Trap.

In order to set the alarm, first fasten the base in any convenient place. Carry the string across the room and fasten it. Adjust the string so that the lever is half-way between the two ends of the strip, *A*.

If the string is disturbed, it will pull the lever over against the strip, *A*. If the string is cut, the spring will pull the lever over to the opposite side. In either case, if the alarm is properly connected to a bell and battery, the circuit will be closed if the string is disturbed, and the bell will ring.

One wire leading from the bell and the battery should be connected to *A*, and the other to the screw and washer, *C*.

The alarm may be arranged across a window or doorway and a black thread substituted for the string. Any one entering in the dark and unaware of the existence of the alarm is liable to break the thread and ring the bell.

An Electric Alarm

It is often desirable to arrange an electrical alarm clock so that a bell will ring continuously until shut off.

Figure 126 shows an electrical alarm attachment. It consists of a wooden box, large enough to receive an ordinary dry cell. A bell is fastened on the outside of the box. Connect one terminal of the battery to one terminal of the bell. Connect the other bell and battery terminals, each to a short piece of brass chain, about four inches long. The ends of the chain are then fastened to a small piece of sheet fiber or hard rubber, so that they are insulated from each other. The opposite end of the fiber is fastened to a piece of wire spring having a garter or suspender clip soldered to the end.

The operation of this electrical attachment is very simple. Wind up the alarm key of an ordinary alarm clock and place the clip on the key. Place the clock in such a position that the two chains do not touch each other. Set the clock. When the mechanical alarm goes off, the key will revolve and twist the two chains, thus closing the electric circuit and causing the bell to ring. The bell will ring until the clamp is removed. The outfit can be attached to any ordinary alarm clock.

An Annunciator

Annunciators are often placed in bell and burglar alarm-circuits to indicate where the button ringing the bell was pushed, in case there are several.

The separate indicators used on an annunciator are called *drops*.

A drop may be made from an electromagnet and some brass strips, etc.

The frame is cut from heavy sheet-brass and shaped as shown in Figures 128 and 129.

The drop bar is a strip of metal which is pivoted on the frame at its lower end and has the upper end turned up to receive a numeral or letter.

The armature is made from a strip of sheet-iron. It is pivoted on the frame at its upper end. The strip is bent at right angles so as to fall in front of the magnet. The lower part of the armature is bent into a hook. The hook fits into a slot cut in the drop bar. A fine wire spring is placed between the frame and the

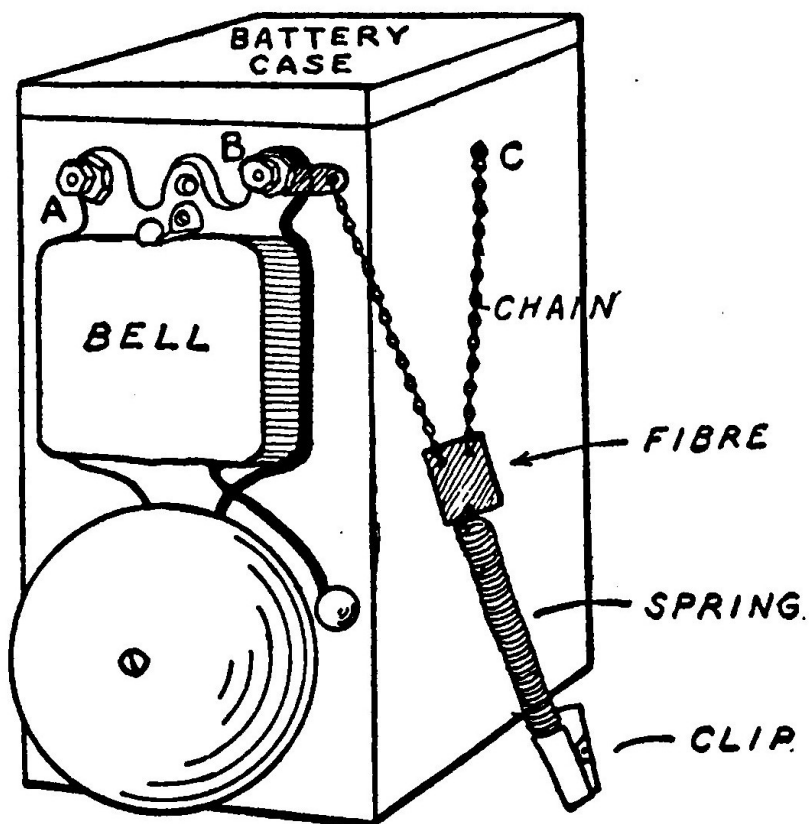

Fig. 126.—An Early-Riser's Electric Alarm Attachment for a Clock.

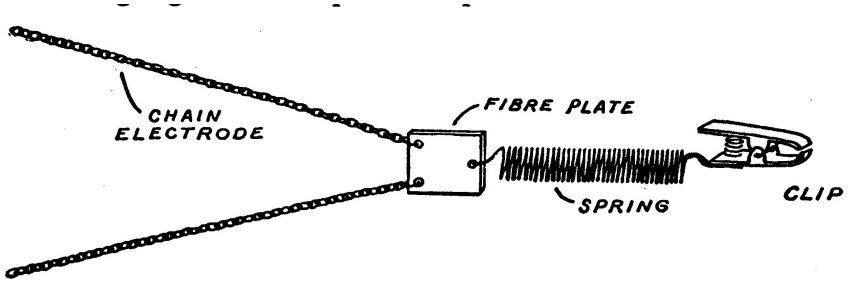

Fig. 127.—Details of the Chain Electrodes, etc.

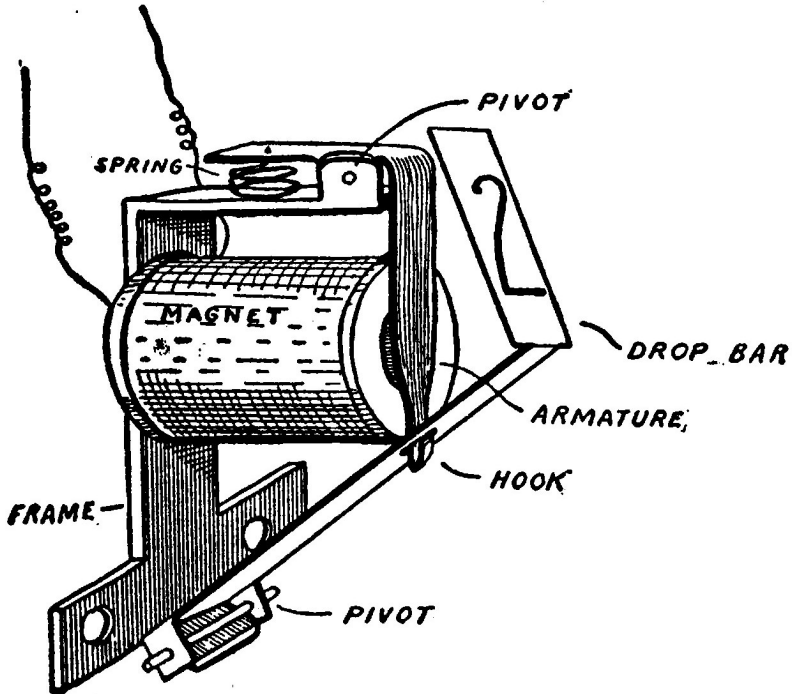

Fig. 128.—An Annunciator Drop.

upper end of the armature so as to pull the armature away from the core when the current is not passing through the magnet.

The electromagnet should be wound with No. 25 B. & S. cotton-covered magnet wire.

When a current is sent through the magnet, it will draw the armature in. This action releases the hook from the edge of the slot in the drop bar and permits the bar to drop and bring the number or letter down into view.

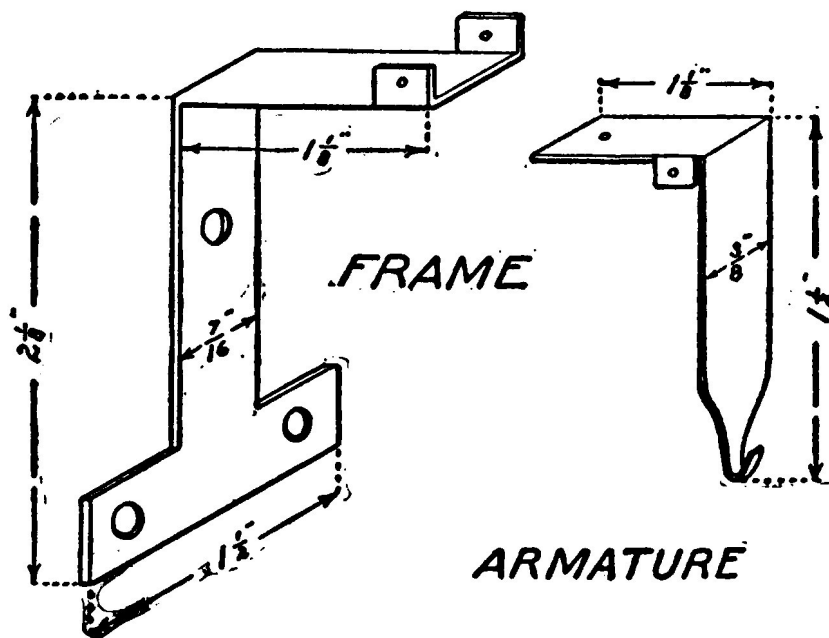
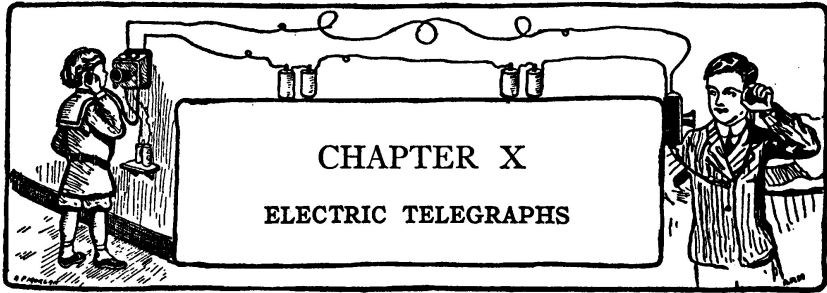

Fig 129.—Details of the Drop-Frame and Armature.

A number of "drops" may be arranged on a board and placed in different circuits so as to indicate which circuit is closed at any time. It is a good plan to arrange a bar to act as a stop, so that the numeral will not drop down too far. Each time that any one of the drops falls, it must be reset by pushing the bar back into position.

CHAPTER X ELECTRIC TELEGRAPHS



Experiments in telegraphy were carried out as far back as the year 1753, when it was proposed to transmit messages by representing the letters of the alphabet by combinations of sparks produced by a static machine; but these were of little practical value and nothing of any importance was accomplished until after the discovery of galvanic current.

Many of these old experiments were very crude and appear somewhat ridiculous when compared with the methods of nowadays. The earliest proposal for an electric telegraph appeared in the *Scots' Magazine* for February, 1753, and shows several kinds of proposed telegraphs acting by the attractive power of electricity, conveyed by a series of parallel wires, one wire corresponding to each letter of the alphabet and supported by glass rods at every twenty yards. Words were to be spelled by the action of the electricity in attracting paper letters, or by striking bells corresponding to letters.

The modern telegraph consists essentially of four things, namely:

A battery which produces an electric current.

A wire which conducts the electric current from one point to another.

A transmitter for shutting the current off and on.

An electro-magnetic receiving apparatus, which gives out in sounds, the signals made by the pulsations of the current from a distant point.

The battery may be almost any form of battery. Gravity cells are preferred, however, for telegraph work.

Heavy galvanized iron wire is usually employed as the "line." It is necessary to use non-conductors wherever the wire is fastened. Glass insulators placed on a wooden pin or bracket, which is fastened to the pole or building on which the wire is to be supported, are used for outside work. Inside of buildings, rubber tubes are used where the wires pass through walls, etc.

The operation of a telegraph is not, as many people suppose, a complicated

or difficult matter to understand, but is quite simple.

The key is a contrivance for controlling the passage of the electric current in much the same manner as an ordinary switch. It consists of a steel lever, swung on trunnion-screws mounted in a frame, and provided with a rubber knob which the operator grasps lightly with the thumb and forefinger. On pressing the lever downward, a platinum point fastened on the under side of the lever is brought into contact with another point set into a rubber bushing in the base of the key, so that there is no electrical connection between the two points unless the key is pressed down or "closed," as it is often termed. The key is usually fastened to the operating bench by two rods called "legs." The lever is provided with screws which permit the stroke of the key to be very closely adjusted.

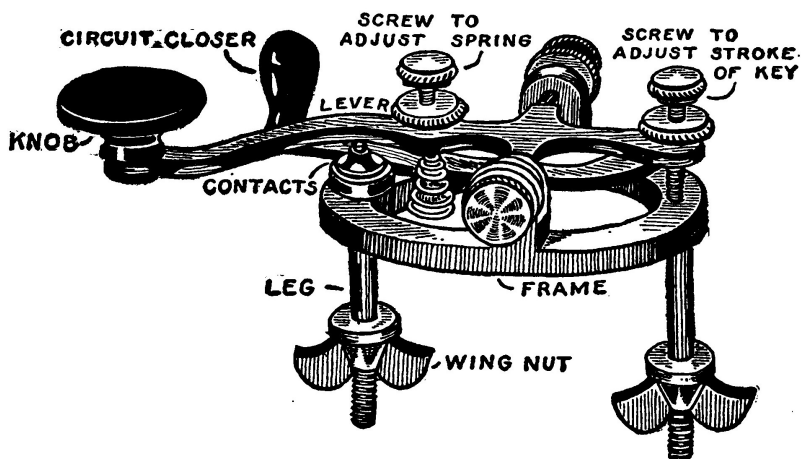

Fig. 130.—A Typical Telegraph Key, showing the Various Parts.

The line wire and battery are connected to the key, so that no current can flow until the key is pressed and the contacts brought together.

A "sounder" consists of two electromagnets mounted on a base under a movable flat piece of iron which is attracted by the magnetism of the electromagnets when a current flows through them and is withdrawn by a spring when no magnetism excites the windings.

This piece of iron, which is called the armature, is mounted upon a strip of brass or aluminum called the lever. The lever strikes against a brass "anvil" and produces the "clicks," which form the dots and dashes of the telegraph alphabet.

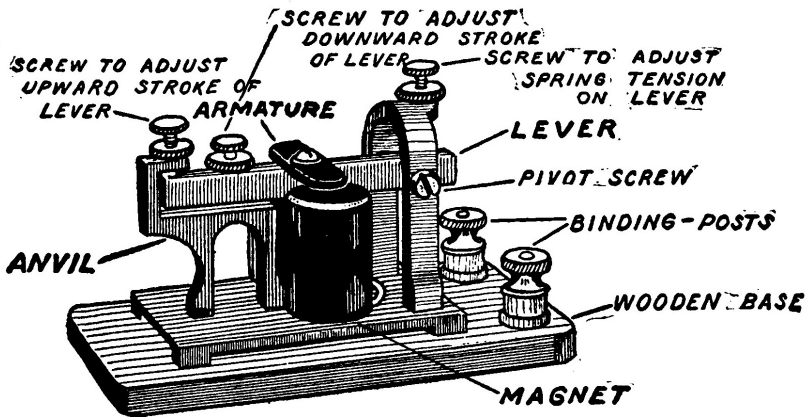

Fig. 131.—A Typical Telegraph Sounder, showing the Various Parts.

Every time that the key is pressed, an electric current is sent out into the line. The current flows through the magnets of the sounder and causes the armature to be drawn downward. The lever strikes the anvil and produces a "click." When the key lever is released, the current is shut up and the lever flies up and clicks against the top of the anvil.

The period of time between the first click and the second click may be varied at will according to the length of time that the key is held down. A short period is called a *dot* and a long period a *dash*. Combinations of dots, dashes, and spaces arranged according to the Morse Alphabet, make intelligible signals.

How To Make a Simple Key and Sounder

The little telegraph instruments shown in Figures 132 and 133 are not practical for long lines but may be used for ticking messages from one room to another, and can be made the source of much instruction and pleasure.

The key is a strip of brass fastened to a wooden base in the manner shown in Figure 132. It is fitted with a knob of some sort on the front end, so that it is conveniently gripped with the fingers.

The little bridge is made from heavy sheet-brass and prevents the lever from moving too far away from the contact on the upward stroke.

Connections are made to the key lever at the back end and the contact in

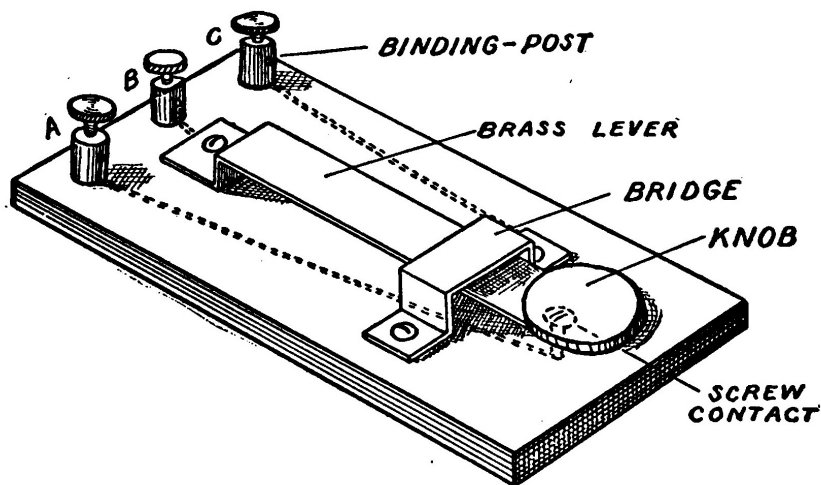

Fig. 132.—A Simple Home-made Telegraph Key.

front by the binding-posts, A and B. The post, C, connects with the bridge.

The sounder consists of two small electromagnets mounted in a vertical position on a wooden base. The magnets are connected at the bottom by a strip of heavy sheet-iron which acts as a yoke.

The armature is made out of sheet-iron, rolled up in the manner shown in the illustration. One end of the armature is fastened to a wooden block in such a position that the armature comes directly over the magnets and about one-eighth of an inch above them. The opposite end of the armature moves up and down for about an eighth of an inch between two screws, each fastened in a wooden block mounted on an upright board in the back of the magnets. The purpose of the screws is to make the "click" of the sounder louder and clearer than it would be if the armature only struck the wood.

A rubber band or a small wire spring passing over a screw and connected at the other end to the armature will draw the latter away from the magnets when the current is not passing.

The terminals of the magnets are connected to binding-posts mounted on the base.

The key and sounder should be placed in series with one or two cells of a battery. Pressing the key will then cause the armature of the sounder to be drawn

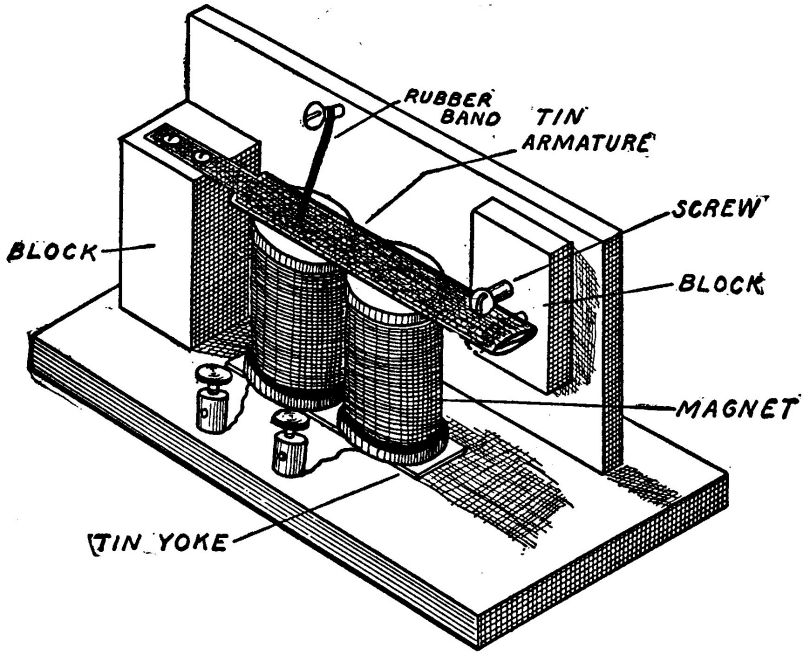

Fig. 133.—A Simple Home-made Telegraph Sounder.

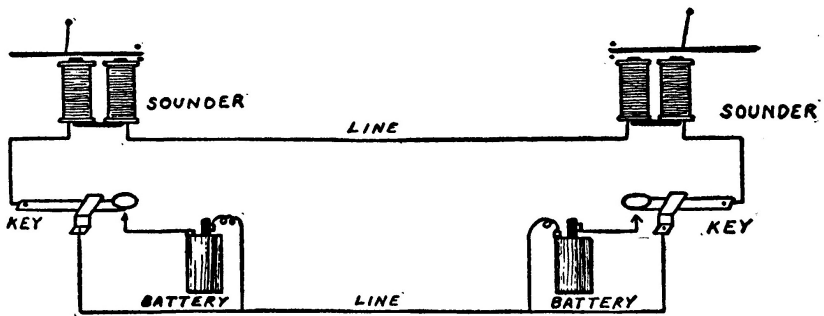

Fig. 134.—A Diagram showing how to connect two Simple Telegraph Stations.

down and make a click. When the key is released, the armature will be drawn up by the spring or rubber band and make a second click.

Hardly a boy interested in mechanics and electricity has not at some time or other wished for a telegraph instrument with which to put up a "line" with his chum.

A practical working set of such instruments can be very easily constructed, and with little expense, by following the sketches and instructions given here.

The magnets for the sounder may either be constructed by the intending telegraph operator or secured from some old electrical instrument such as a magneto-bell. In the latter case, the hardest part of the work will be avoided.

If they are to be home-made, the following suggestions may prove of value in carrying out their construction.

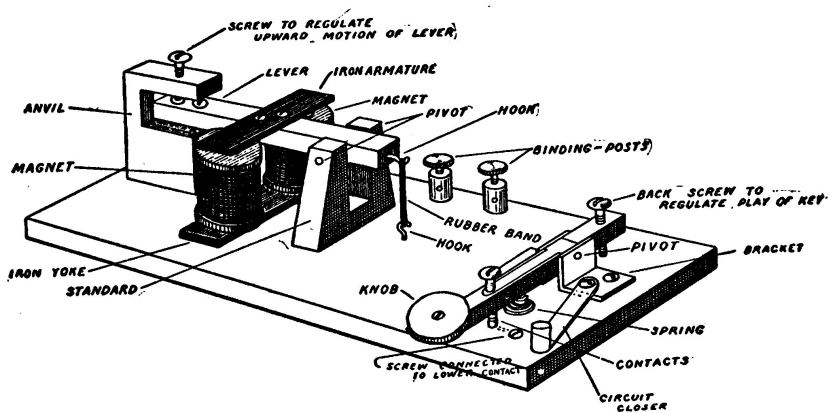

Fig. 135.—A Complete Telegraph Set, consisting of a Keyboard and a Sounder.

The cores are made from one-quarter-inch stove-bolts with the heads cut off. The magnet heads are cut out of hard-wood fiber, one-eighth of an inch thick and one inch in diameter. They should fit tightly and be held in place with glue. They are separated so as to form a winding space between of seven-eighths of an inch. The magnets should be wound full of No. 25 B. & S. gauge cotton-covered wire.

The yoke is made of enough strips of sheet-iron, one-half inch wide and two inches long, to form a pile one-quarter of an inch thick. Two one-quarter-inch holes are bored in the opposite ends of the yoke, one and one-half inches apart. The lower ends of the magnet cores are passed through these holes. The

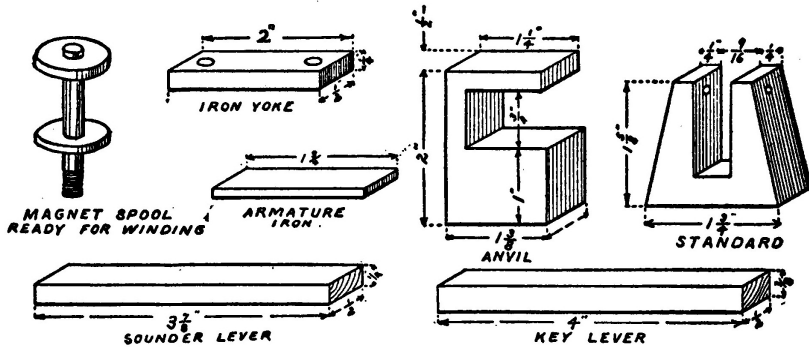

Fig. 136.—Details of the Telegraph Set shown in Figure 135.

ends should project one-half of an inch beyond the yoke.

They are passed through two holes in a base-board three-quarters of an inch thick. The holes are countersunk from the lower side, so that a nut can be screwed on the lower end of each and the magnets held tightly in an upright position. The remaining parts of the instrument are very easily made, and are so clearly shown by the drawing that it is hardly necessary to say more than a few words in explanation.

The lever or tongue, the anvil, the standard, and the lever of the key are all cut out of hard-wood according to the pattern shown in the illustration.

The armature is a piece of soft iron fastened to the lever with a small brass screw.

Tacks are placed under the heads of the adjusting screws on the sounder so that it will click more loudly.

The rubber band acts as a spring to counteract the weight of the armature and lever and draw it up as soon as the current is cut off. The movement of the lever should be so adjusted that it is only sufficient to make an audible click.

Use care to avoid friction between the lever and the standard, so that the former will move with perfect freedom.

All the screws used in the work should be round-headed brass wood screws with the points filed flat. Bore a small hole before screwing them into place so as to avoid splitting the wood.

The construction of the key is even more simple than that of the sounder. It should move up and down without any side motion.

The circuit-closer should be kept closed when the instruments are not in

use, and when you are receiving a message. As soon as you are through receiving and wish to transmit, you should open your circuit-closer and your friend close his.

The tension of the spring under the lever of the key must be adjusted to suit the needs of each individual operator.

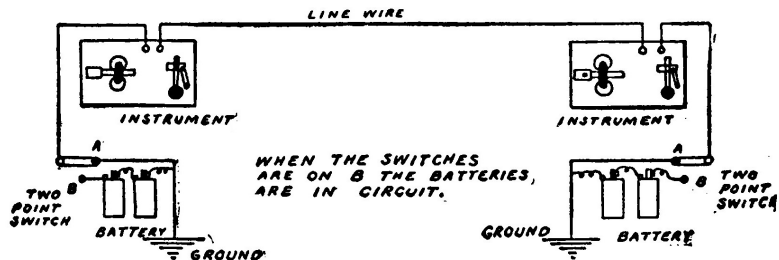

Fig. 137.—A Diagram showing how to connect two Complete Telegraph Sets, using one Line Wire and a Ground. The Two-Point Switches throw the Batteries out of Circuit when the Line is not in use.

The diagram for connecting the instruments is self-explanatory. In cities or towns where a "ground" is available by connecting to the gas or water pipes, one line wire may be easily dispensed with. Or, if desirable, a ground may be formed by burying a large plate of zinc (three or four feet square) in a moist spot and leading the wire to it.

How To Build a Telegraph Relay

In working a telegraph over a long line or where there are a large number of instruments on one circuit, the currents are often not strong enough to work the sounder directly. In such a case a *relay* is used. The relay is built on the same principle as a sounder, but the parts are made much lighter, so that the instrument is more sensitive. The armature of a relay is so small and its movement so little that its clicking is scarcely audible. It is therefore fitted with a second set of contacts and connected to a battery and a sounder, which is to set in operation every time the contacts close. The principle of a relay is that a weak current of insufficient strength to do the work itself may set a strong local current to do its work for it.

There are many forms of relays, and while that which is described below is not of the type commonly used on telegraph lines, it has the advantage of being

far more sensitive than any instrument of the regular line relay type that the average experimenter could build.

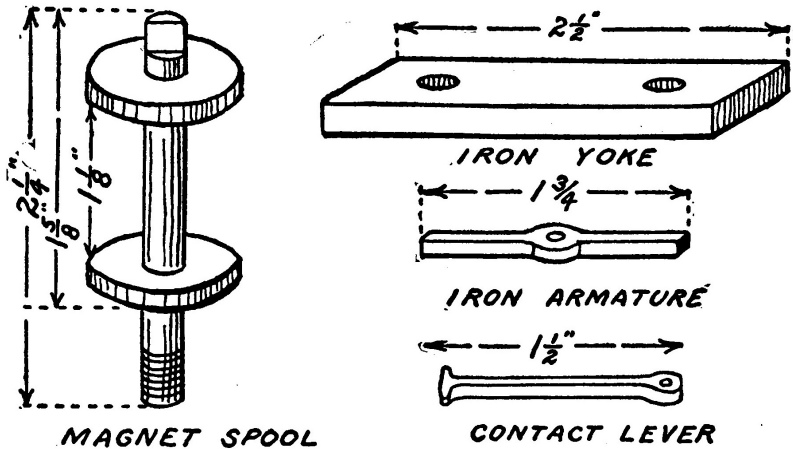

Fig. 138.—Details of the Relay Parts.

Make the magnets from one-quarter-inch stove-bolts, and cut them off so that they will form a core about two and one-quarter inches long. Fit each of the cores with two fiber heads to hold the wire in place. Insulate the legs with paper and wind each with about fifty layers of No. 30 B. & S. gauge single-cotton-covered magnet wire. The winding space between the magnet's heads should be one and one-eighth inches.

The upper ends of the magnet cores should be allowed to project about one-quarter of an inch beyond the fiber head. The end of the core is filed flat, as shown in the illustration.

The magnets are mounted upon an iron yoke, three-sixteenths of an inch thick. The holes in the yoke should be spaced so that there is a distance of one and one-half inches between the centers of the magnet cores.

The armature of the relay is mounted on a small steel shaft with sharp points at each end. The exact shape of the armature may be best understood from the illustrations.

The lower end of the shaft rests in a small cone-shaped depression made by driving a center punch into the yoke half-way between the two magnets.

The top bearing is a strip of brass projecting from a wooden support. The end of the shaft rests in a depression similar to that in the yoke.

The contact lever is made of brass and forced on the shaft below the armature. It swings between a small brass clip fastened to one side of the support and a little screw held in a similar clip on the opposite side.

The contact clip is made of spring brass about No. 22 gauge in thickness. It may be adjusted by a screw passing through the support.

The armature may be controlled in its movement so that the latter will be very slight by adjusting the screws.

There should not be any friction in the bearings and the armature should move with perfect freedom. The armature should approach the ends of the magnet cores until a space about the thickness of heavy paper separates them and should not touch them.

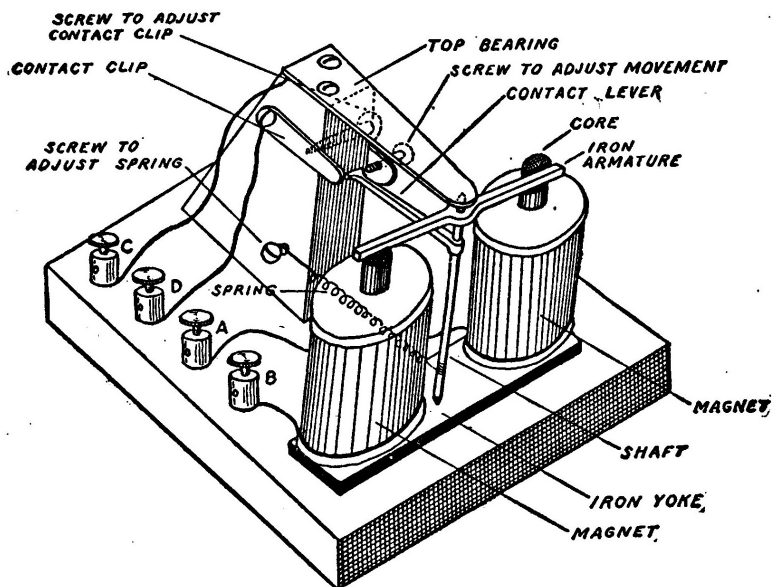

Fig. 139.—The Completed Relay.

The spring is made of fine brass wire. It is fastened to the armature shaft, and the screw mounted on the wooden support with a piece of silk thread. The thread is passed around the shaft once or twice so that the tension of the spring will cause the armature to move away from the pole pieces just as soon as the current flowing through the magnets ceases.

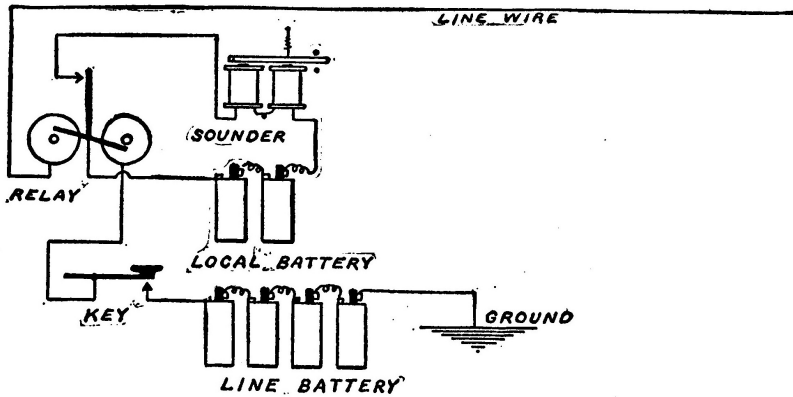

Fig. 140.—A Diagram showing how to connect a Relay, Sounder, and Key. Closing the Key will operate the Relay. The Relay will then operate the Sounder in turn.

The tension of the spring may be adjusted by turning the screw with a screw-driver. If the armature tends to stick to the magnet poles fasten a small piece of paper to the poles with some shellac.

The terminals of the magnets are connected to two binding-posts marked A and B. The binding-posts marked C and D are connected respectively to the contact clip and the brass bearing on the top of the wooden support.

The diagram in Figure 140 shows how the relay is connected to a telegraph line.

How To Learn To Telegraph

The instruments so far described have been practical working telegraph instruments, but they lack the fine points of commercial apparatus and it is not possible to become as efficient an operator with their aid as with a real key and sounder.

If the young experimenter desires to become a proficient telegraph operator, the first thing to do is to purchase a Learner's telegraph key and sounder.

Connect a dry cell to the binding-posts on the back of the instrument. Screw the set down on a table about eighteen inches from the front edge, so that there is plenty of room for the arm to rest. See that none of the various adjustment screws about the instrument are loose and that the armature of the sounder moves freely up and down through a distance of about one-sixteenth of an inch.

The spring which draws the lever upwards away from the magnets should be set only at sufficient tension to raise the lever when no current is passing. If too tight, the spring will not allow the armature to respond to the current flowing through the magnets.

The key is provided with several adjustment-screws to regulate the tension and the play of the lever to suit the hand of the operator. A little practice will enable the student to judge best for himself just how the key should be set.

The next step is to memorize the alphabet, so that each character can instantly be called to mind at will. The punctuation marks are not used very frequently, and the period is the only one which the student need learn at first.

The Morse alphabet consists of dots, dashes, and spaces. Combinations of these signals spell letters and words.

Many of the characters are the reverse of others. For example, *A* is the reverse of *N*, *B* and *F*, *D* and *U*, *C* and *R*, *Q* and *X*, *Z* and *&*, are the other reverse letters, so if the formation of one of each of these letters is memorized the reverse is easily mastered.

It is important that the beginner should learn how properly to grasp the key, for habits are easily formed and a poor position will limit the sending speed of the operator.

Place the first or index finger on the top of the key-handle, with the thumb under the edge; and the second finger on the opposite side. The fingers should be curved so as to form a quarter-section of a circle. Bring the third and fourth fingers down so that they are almost closed on the palm of the hand. Rest the arm on the table in front of the key and allow the wrist to be perfectly limber.

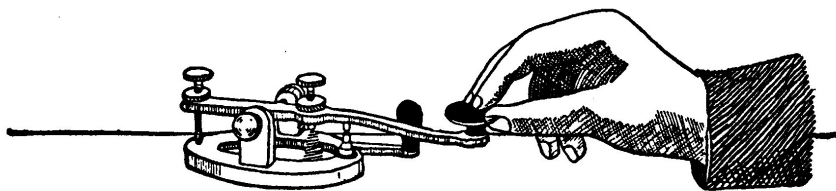

Fig. 141.—How to hold a Telegraph Key.

The grasp on the key should be firm but not rigid. Avoid using too much strength or a light hesitating touch. Endeavor to acquire a positive, firm up and down motion of the key. Avoid all side pressure, and do not allow the fingers to leave the key when making the signals. The movement is made principally with

the wrist, with the fingers and hand perfectly elastic.

A dot is made by a single instantaneous, downward stroke of the key. A dash is made by holding the key down for the same period of time that it takes to make three dots. A long dash is made by holding the key down for the same time that it takes to make five dots.

A space in the letters, such as, for instance, the space between the first and last two dots in the letter *R* should occupy the time of one dot. The space between each letter should occupy the time required for two dots, and the space between words should occupy the time required for three dots.

Commence the use of the key by making dots in succession, first at the rate of two every second, and increasing the speed until ten can be made. Practice should be continued until three hundred and sixty dots a minute can be made with perfect regularity.

Then begin making dashes at the rate of two every three seconds, and continue until one hundred and twenty a minute can be made with perfect regularity.

Practise the long dashes at the rate of one a second, and increase until ninety can be made in a minute.

When this has been accomplished, practise the following letters until they can be perfectly made. Each row of letters is an exercise which should be practised separately until mastered.

Dot Letters

E I S H P 6

Dot and Space Letters

O C R Y Z &

Dash Letters

T L M 5 O

Dots and Dashes

A U V 4

Dashes and Dots

N D B 8

ALPHABET

A	B	C	D	E	F
● ■■■■ ●	■■■■●●●●	●●●	■■■■●●	●	●■■■■●
G	H	I	J	K	L
■■■■■■●	●●●●	●●	■■■■●■■■■●	■■■■●■■■■	■■■■■
M	N	O	P	Q	R
■■■■■■■■	■■■■●	●●	●●●●●●	●●■■■■●	●●●●
S	T	U	V	W	X
●●●	■■■	●●■■■	●●●■■■	●■■■■■■	●■■■■●
Y	Z	&	\$		
●●●●	●●●●●	●●●●	●●●●■■■■●●		

NUMERALS

1	2	3	4
●■■■■■■■■●	●●■■■■●●	●●●■■■■●	●●●●■■■
5	6	7	8
■■■■■■■■■■	●●●●●●	■■■■■■■■●●	■■■■●●●●
9	0		
■■■■●●■■■	■■■■■■■■		

PUNCTUATION

Comma	Period	Semicolon	Interrogation
		;	?
●■■■■●■■■	●●■■■■■■■■●●	●●●●●	■■■■●●■■■■●

Fig. 142.—The Morse Telegraphic Code.

Mixed Dots and Dashes

F G J K Q W X 1 2 3 7 9 Period

After you can write these different letters, practise making words. Select a list of commonly used words. When words seem easy to write, practise sending pages from a book.

Systematic and continual practice will enable the student to make surprising progress in mastering the art of sending.

Reading and receiving messages must be practised with a companion student. Place two instruments in separate rooms or in separate houses so that the operators will be entirely dependent upon the instruments for their communication with each other. Start by transmitting and receiving simple messages. Then use pages from a book, and increase the speed until it is possible to send and receive at least 15 words a minute without watching the sounder but merely depending upon the clicks to determine the duration of the dots and dashes.

Figure 140 shows how to arrange a regular telegraph line for two stations. Gravity batteries should be used for regular telegraph work. It is necessary that the key should be kept closed by having its circuit-closer shut when messages are not being sent. If one of the keys is left open the circuit is broken, and it is not possible for a person at the other end of the line to send a message.

Every telegraph office has a name or call usually consisting of two letters; thus for New York the call might be N. Y. and for Chicago, C. H.

If New York should desire to call Chicago, he would repeat the call letters, C H., until answered. Chicago would answer by sending I, several times and signing, C H. When so answered, New York would proceed with the message.

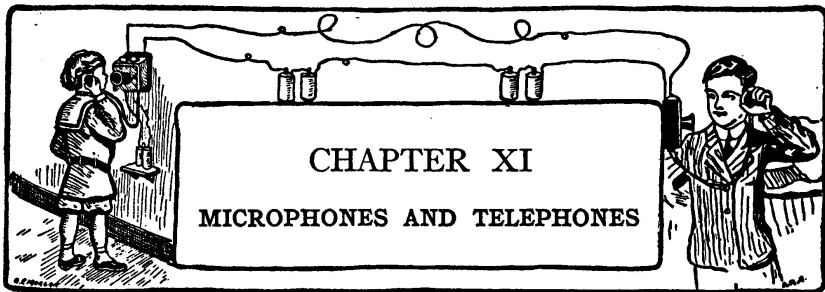

CHAPTER XI MICROPHONES AND TELEPHONES

In 1878, David Edward Hughes discovered that the imperfect contact formed between two pieces of some such substance as carbon or charcoal is very sensitive to the slightest changes in pressure, and when included in an electric circuit with a battery and a telephone receiver, will transmit sounds. Such an instrument is called a *microphone*. It has various forms but in most of them one piece of carbon or charcoal is held loosely between two other pieces in such a manner as to be easily affected by the slightest vibrations conveyed to it through the air or any other medium.

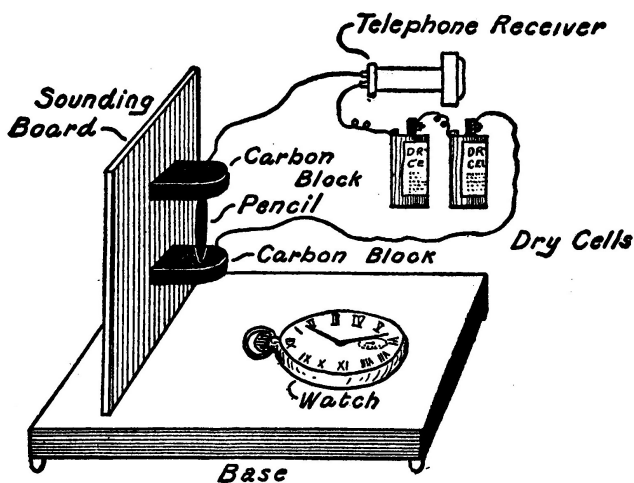

Fig. 143.—A Microphone connected to a Telephone Receiver, and a Battery.

Figure 143 illustrates a simple form of instrument embodying this principle. A small pencil of carbon is supported loosely between two blocks of the same substance glued to a thin wooden sounding-board of pine. The sounding-board is mounted in an upright position on a wooden base. The carbon pencil rests loosely in two small indentations in the carbon blocks. The blocks are connected, by means of a very fine wire or a strip of tinfoil, with one or two cells of battery and a telephone receiver. Any vibration or sounds in range of the microphone will cause the sounding-board to vibrate. This will affect the pressure of the contact between the carbon pencil and the two blocks. When the pressure between the two is increased the resistance in the path of the electric current is decreased

and more current immediately flows through the circuit. On the other hand, when the pressure is decreased, the resistance is increased and less current flows through the telephone receiver. The amount of current flowing in the circuit thus keeps step with the changes in the resistance, and accordingly produces sounds in the telephone receiver. The vibrations emitted from the receiver are usually much greater than those of the original sounds, and so the microphone may be used to magnify weak sounds such as the ticking of clock-wheels or the footfalls of insects. If a watch is laid on the base of the microphone, the ticking of the escapement wheel can be heard with startling loudness. The sounds caused by a fly walking on a microphone may be made to sound as loud as the tramp of a horse.

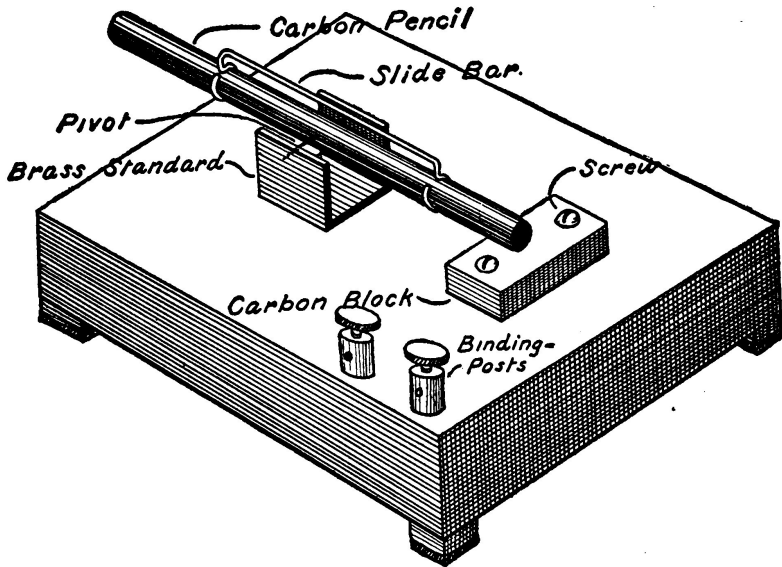

Fig. 144.—A Very Sensitive Form of Microphone, with which the Footsteps of a Fly can be heard.

The electrical *stethoscopes* used by physicians to listen to the action of the heart are in principle only a microphone and telephone receiver connected to a battery.

The drawing in Figure 144 illustrates a very sensitive microphone that is quite easy to make. With this instrument it is possible to hear the tramping of a

fly's feet or the noise of its wings.

The base upon which the apparatus is mounted serves as the sounding-board and is made in the form of a hollow wooden box. It can be made from an ordinary cigar-box by removing the paper and taking the box apart. The piece forming the top of the box must be planed down until it is only three thirty-seconds of an inch thick. The box should measure about five inches square and three-quarters of an inch thick when finished. Do not use any nails or small brads whatsoever in its construction, but fasten it together with glue. If you use any nails you will decrease the sensitiveness of the instrument quite appreciably. The bottom of the box should be left open. The result is a sounding-board of the same principles as that of the banjo head. Small feet, one-quarter of an inch square, are glued to the four under corners so as to raise the bottom clear of the table, or whatever the microphone may be placed upon. The bottom of each one of the small feet is cushioned with a layer of felt so that no jars will be transmitted to the instrument by any object upon which it is resting.

The carbon pencil used on this type of instrument is pivoted in the center and rests at one end upon a carbon block.

The carbon block is made about one inch long, one-quarter of an inch thick, and one-half of an inch wide. A small hole is drilled near each end to receive a screw which fastens the block to the sounding-board. A fine wire is led from one of these screws to a binding-post mounted at the side of the box. Another wire leads from a second binding-post to a standard which is also fastened to the sounding-board with a small screw.

The standard is made from a sheet of thin brass and is bent into the shape shown in the illustration.

The pencil is a piece of one-quarter-inch carbon rod, two and three-quarter inches long. A small hole is drilled one and five-eighths of an inch from one end with a sewing-needle, and a piece of fine brass wire, pointed at both ends, pushed in. The wire should be a tight fit in the hole. It should be about one-half of an inch long, and may be made from an ordinary pin.

The slide-bar is used to regulate the pressure of the pencil upon the carbon block and is simply a piece of soft copper wire about one-eighth of an inch in diameter. It is bent into the shape shown in the illustration so that it will slide over the carbon pencil. The sides of the standard should press just tightly enough against the ends of the pivot which passes through the carbon pencil to hold it in position without slipping, and at the same time allow it to swing freely up and down.

The two binding-posts should be connected in series with two dry cells and a pair of good telephone receivers. Place the receivers against the ears. Move the slide-bar gently back and forth until the voice of any one talking in another part

of the room can be heard distinctly in the telephone receivers. In order to hear faint whispers, move the slide-bar away from the carbon block.

In order to hear a fly walk it is necessary to have the carbons very dry and clean. The instrument must be very carefully adjusted. Cover the microphone with a large glass globe and place a fly inside of the globe. Whenever the fly walks on any part of the microphone you will be able to hear each footstep in the telephone receivers. When he flies about inside of the globe, his wings will cause a loud roaring and buzzing noise to be heard in the receivers.

Telephones

Not many years ago, when the telephone made its first appearance, it was the wonder of the times just as wireless telegraphy is to-day. Starting as an exceedingly simple and inexpensive apparatus, it has gradually developed into a wonderful and complex system, so that at the present time, instead of experiencing difficulty in telephoning over distances of fifty or one hundred miles, as at first, it is possible to carry on a conversation over a line two thousand miles long as easily as it is face to face.

Like the telegraph, the principle of the telephone is that of a current of electricity flowing over a line wire into a pair of electro-magnets, but with many important differences.

When compared with telegraph apparatus, the telephone is found to be exceedingly sensitive. A telegraph relay requires perhaps about one-hundredth of an ampere to work it properly. A telegraph sounder will require about one-tenth of an ampere, but a telephone receiver will render speech audible with less than a millionth of an ampere, and therefore may almost be said to be a hundred thousand times more sensitive than a sounder.

Another difference between the telephone and the telegraph lies in the fact that the currents flowing over a telegraph line do not usually vary at a rate greater than twenty or thirty times a second, whereas telephone currents change their intensity hundreds of times a second.

The telephone is an instrument for the transmission of speech to a distance by means of electricity, wherein the speaker talks to an elastic plate of thin sheet-iron which vibrates and sends out a pulsating current of electricity.

The transmission of the vibrations depends upon well-known principles of electricity, and does not consist of the actual transmission of sounds, but of electrical impulses which keep perfect accord or step with the sound waves produced by the voice in the transmitter. These electrical currents pass through a pair of small electro-magnets acting upon a plate or diaphragm, which in turn agitates the air in a manner similar to the original voice speaking into the transmitter and

thus emits sounds.

That part of the apparatus which takes up the sounds and changes them into electric currents composes the *transmitter*. When words are spoken into the mouthpiece they strike a diaphragm, on the back of which is fastened a small cup-shaped piece of carbon. A second cup is mounted in a rigid position directly back of the first. The space between them is filled with small polished granules of carbon. When these granules are in a perfectly loose state and are undisturbed, their resistance to an electric current is very great and they allow almost none to flow.² When slightly compressed their resistance is greatly lowered and they permit the current to pass. The vibrations of the diaphragm cause the carbon cup mounted on its back to move and exert a varying pressure upon the granules with a corresponding variation in their resistance and the amount of current which will pass through.

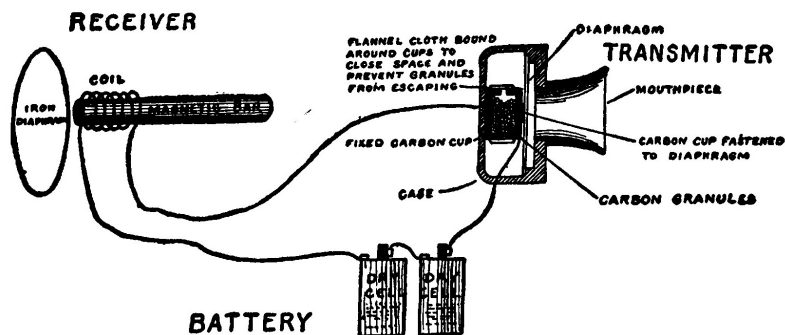

Fig. 145.—A Telephone System, consisting of a Receiver, Transmitter, and a Battery connected in Series. Words spoken into the Transmitter are reproduced by the Receiver.

The *receiver*, or that part of the apparatus which transforms the pulsating current back into sound waves consists of a thin iron disk, placed very near but not quite touching the end of a small steel bar, permanently magnetized, and about which is wound a coil of fine insulated wire.

The transmitter and the receiver are connected together in series with a battery as in Figure 145. When words are spoken into the transmitter the little carbon granules are immediately thrown into motion, and being alternately

²A transmitter is really a microphone built especially to receive the sounds of the human voice, and operates on the same principle.

compressed and released cause corresponding changes in the current flowing through the receiver from the battery. The magnetism of the receiver changes with each change in the electric current, and thus by alternately attracting and repelling the diaphragm causes it to vibrate and emit sounds. Such is the *principle* of the telephone. The telephones in actual service to-day are complicated with bells, magnetos, induction coils, condensers, relays, and various other apparatus, which fact renders them more efficient.

The bells and magnetos are for the purpose of calling the central operator or the person at the other end of the line and drawing attention to the fact that some one wishes to get into communication with him. The older styles of telephones used what is known as a polarized bell and a hand magneto for this purpose. A polarized bell is a very sensitive piece of apparatus which will operate with very little current. A magneto is a small hand dynamo which when turned with a crank will generate a current causing the bell at the other end of the line to ring. When the telephone receiver is raised off its hook in order to place it to the ear the bell and magneto are automatically disconnected from the line and the receiver and the transmitter are connected in their place. The current necessary to supply the telephone and receiver is supplied by two or three dry cells placed inside of each telephone.

The latest types of instruments employ what is known as the central energy system, wherein the current is supplied by a large storage battery located at the central office and serving as a current supply to all the telephones connected to that system.

It would be impossible to enter into the history of the telephone far enough to explain the details of some of the various systems in every-day use in such a book as this because of the immense amount of material it would be necessary to present. Such a work would occupy a volume of its own. Additional information may be readily found in any reference library. However, the "boy electrician" who wishes to make a telephone for communicating between the house and barn, or with his chum down the street, will find the necessary information in the following pages. If this work is carried out carefully and a home-made telephone system built and installed it will not only prove a very interesting undertaking but will also serve to dispel all mystery which may surround this device in the mind of the young experimenter.

How to Build a Telephone

Telephone receivers are useful for many purposes in electrical work other than to receive speech. They are used in connection with wireless instruments, in place of a galvanometer in measuring electrical circuits, and for testing in various ways.

Telephone receivers are of two types. One of them is long and cumbersome, and is very similar to the original Bell telephone receiver. The other is small and flat, and is called a "watch-case" receiver. A watch-case receiver is shown in Figure 146. It consists of a U-shaped permanent magnet so mounted as to exert a polarizing influence upon a pair of little electro-magnets, before the poles of which is placed an iron diaphragm. For convenience, these parts are assembled in a small cylindrical casing, usually of hard rubber. The permanent magnet exerts a continual pull upon the diaphragm, tending to draw it in. When the telephone currents pass through the little magnets, they will either strengthen the permanent magnet and assist it in attracting the diaphragm, or detract from its strength and allow the diaphragm to recede, depending upon which direction the current flows.

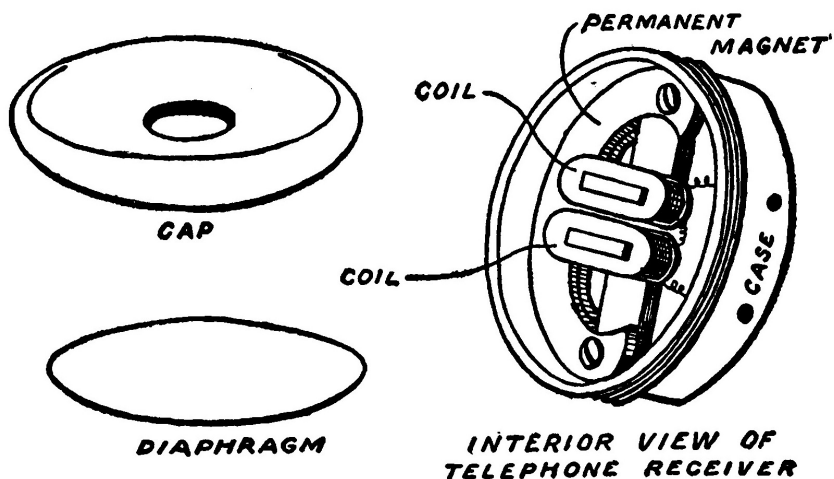

Fig. 146.—A Watch-Case Telephone Receiver.

Watch-case receivers are usually employed for wireless telegraph work because they are very light in weight and can easily be attached to a head-band in order to hold them to the ears and leave the hands free. Watch-case receivers can be purchased for forty-five to seventy-five cents at almost any electrical supply house. They are very useful to the amateur experimenter in many ways.

A telephone receiver capable of giving fair results on a short telephone line can be very easily made, but of course will not prove as efficient as one which is purchased ready-made from a reliable electrical manufacturer.

The first practical telephone receiver was invented by Alexander Graham Bell and was made somewhat along the same lines as that shown in Figure 147.

Such a receiver may be made from a piece of curtain-pole, three and three-quarter inches long and about one and one-eighth inches in diameter. A hole, three-eighths of an inch in diameter, is bored along the axis throughout its entire length, to receive the permanent magnet.

The shell of the receiver is a cup-shaped piece of hard wood, two and one-half inches in diameter and one inch deep. It will have to be turned on a lathe. Its exact shape and dimensions are best understood from the dimensions shown in the cross section in Figure 147. The shell is firmly attached to one end of the piece of curtain-pole by gluing.

The permanent magnet is a piece of hard steel, three-eighths of an inch in diameter and four and five-eighths of an inch in length. The steel will have to be tempered or hardened before it will make a suitable magnet, and the best way to accomplish this is to have a blacksmith do it for you by heating the rod and then plunging it into water when just at the right temperature.

One end of the bar is fitted with two thick fiber washers about seven-eighths of an inch in diameter and spaced one-quarter of an inch apart. The bobbin so formed is wound full of No. 36 B. & S. gauge single-silk-covered magnet wire. The ends of the wire are passed through two small holes in the fiber washers and then connected to a pair of heavier wires. The wires are run through two holes in the curtain-pole, passing lengthwise from end to end, parallel to the hole bored to receive the bar magnet.

This bar magnet is then pushed through the hole until the end of the rod on which the spool is fixed is just below the level of the edges of the shell.

The two wires are connected to binding-posts, *A* and *B*, mounted on the end of the receiver. A hook is also provided so that the receiver may be hung up.

The diaphragm is a circular piece of thin sheet-iron, two and one-half inches in diameter. It is placed over the shell, and the bar magnet adjusted until the end almost touches the diaphragm. The magnet should fit into the hole very tightly, so that it will have to be driven in order to be moved back and forth.

The diaphragm is held in place by a hard-wood cap, two and three-quarter inches in diameter and having a hole three-quarters of an inch in diameter in the center. The cap is held to the shell by means of four small brass screws.

The receiver is now completed and should give a loud click each time that a battery is connected or disconnected from the two posts, *A* and *B*.

The original Bell telephone apparatus was made up simply of two receivers without any battery or transmitter. In such a case the current is generated by "induction." The receiver is used to speak through as well as to hear through. This method of telephoning is unsatisfactory over any appreciable distances. The

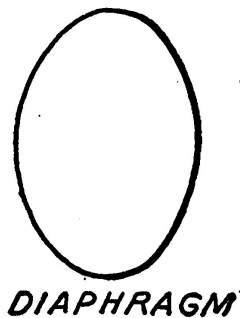
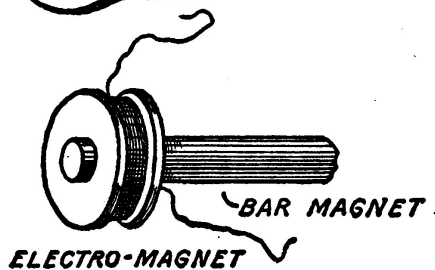
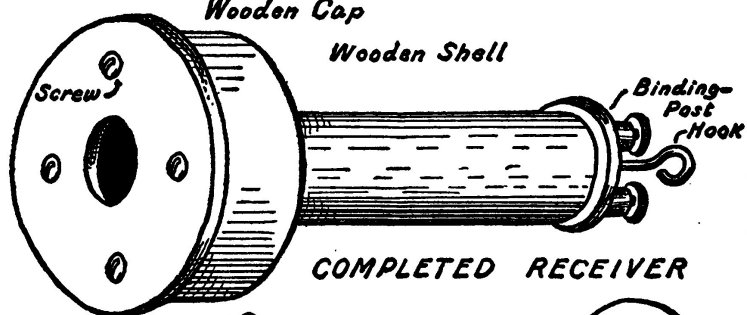
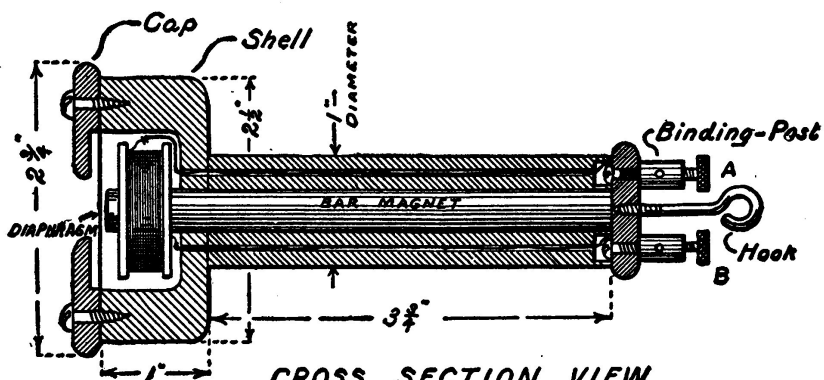

Fig. 147.—A Simple Form of Telephone Receiver.

time utilized in making a transmitter will be well spent.

A simple form of transmitter is shown in Figure 148. The wooden back, *B*, is three and one-half inches square and three-quarters of an inch thick. The front face of the block is hollowed out in the center as shown in the cross-section view.

The face-plate, *A*, is two and one-half inches square and one-half an inch thick. A hole, seven-eighths of an inch in diameter, is bored through the center. One side is then hollowed out to a diameter of one and three-quarter inches, so as to give space for the diaphragm to vibrate as shown in the cross-sectional drawing.

The carbon buttons are one inch in diameter and three-sixteenths of an inch thick. A small hole is bored in the center of each to receive a brass machine screw. The hole is countersunk, so as to bring the head of the screw down as close to the surface of the carbon as is possible. Then, using a sharp knife or a three-cornered file, score the surface of the carbon until it is covered with criss-cross lines.

The diaphragm is a piece of thin sheet-iron cut in the form of a circle two and one-half inches in diameter. A small hole is bored through the center of this. One of the carbon buttons is fastened to the center of the diaphragm with a small screw and a nut.

Cut out a strip of flannel or thin felt, nine-sixteenths of an inch wide and three and one-half inches long. Around the edge of the carbon button mounted on the diaphragm, bind this strip with silk thread in such a manner that the strip forms a cylinder closed at one end with the button.

Fill the cylinder with polished carbon telephone transmitter granules to a depth of about one-eighth of an inch. These granules will have to be purchased from an electrical supply house. They are finely polished small carbon balls, much like birdshot in appearance.

Slip a long machine-screw through the hole in the second carbon button and clamp it in place with a nut. Then place the carbon button in the cylinder so that it closes up the end. The space between the two buttons should be about three-sixteenths of an inch. Bind the flannel or felt around the button with a piece of silk thread so that it cannot slip out of place. The arrangement of the parts should now be the same as that shown by the cross-sectional drawing in the upper right-hand corner of Figure 148.

The complete transmitter is assembled as shown in the lower part of Figure 148.

A small tin funnel is fitted into the hole in the face-plate, *A*, to act as a mouthpiece.

A screw passes through the back, *B*, and connects to the diaphragm. The screw is marked "*E*" in the illustration. A binding-post is threaded on the screw so

that a wire may be easily connected. The screw passing through the back carbon button also passes through a hole in the wooden back, and is clamped firmly in position with a brass nut so that the button is held very rigidly and cannot move. The front button, being attached to the diaphragm, is free to move back and forth with each vibration of the latter.

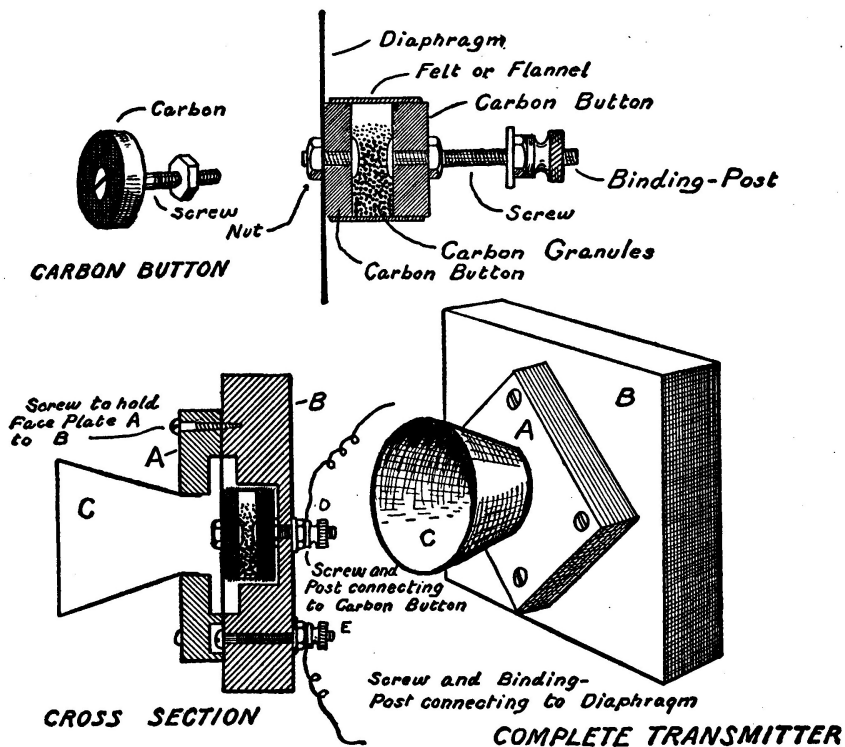

Fig. 148.—A Home-made Telephone Transmitter.

The carbon granules should fill the space between the buttons three-quarters full. They should lie loosely together, and not be packed in.

When connected to a battery and a telephone receiver the current passes from the post, D, to the back button, through the mass of carbon granules into the front button and out at the post, E. When the voice is directed into the mouth-piece, the sound waves strike the diaphragm and cause it to vibrate. The front

button attached to it then also vibrates and constantly changes the pressure on the carbon granules. Each change in pressure is accompanied by an immediate change in resistance and consequently the amount of current flowing.

Figure 149 shows a complete telephone ready for mounting on the wall. It consists of a receiver, telephone transmitter, bell, hook, and push-button. The bell is mounted on a flat base-board. The transmitter is similar to that just described, but is built into the front of a box-like cabinet. The box is fitted with a push-button at the lower right-hand corner. A simple method of making a suitable push-button is shown in the upper left-hand part of the illustration. It consists of two small brass strips arranged so that pushing a small wooden plug projecting through the side of the cabinet will bring the two strips together and make an electrical connection.

The "hook" consists of a strip of brass, pivoted at one end with a round-headed brass wood screw and provided with a small spring, so that when the receiver is taken off of the hook it will fly up and make contact with a screw, marked *C* in the illustration. When the receiver is on the hook, its weight will draw the latter down against the screw, *D*. The hook is mounted on the base-board of the telephone, and projects through a slot cut in the side of the cabinet.

Four binding-posts are mounted on the lower part of the base-board. The two marked *B* and *B* are for the battery.

That marked *L* is for the "line," and *G* is for the ground connection or the return wire.

The diagram of the connections is shown in Figure 150. The line-wire coming from the telephone at the other station enters through the binding-post marked *L*, and then connects to the hook. The lower contact on the hook is connected to one terminal of the bell. The other terminal of the bell leads to the binding-post marked *G*, which is connected to the ground, or to the second line-wire, where two are used.

The post, *G*, and one post, *B*, are connected together. The other post marked *B* connects to one terminal of the transmitter. The other terminal of the transmitter is connected to the telephone receiver. The other post of the telephone receiver leads to the upper contact on the hook marked *C*. The push-button is connected directly across the terminals of the transmitter and the receiver so that when the button is pushed it short-circuits the transmitter and the receiver. When the receiver is on the hook and the latter is down so that it makes contact with *D* any current coming over the line-wire will pass through the bell and down through the ground or the return-wire to the other station, thus completing the circuit. If the current is strong enough it will ring the bell. When the receiver is lifted off the hook, the spring will cause the hook to rise and make contact with the screw marked *C*. This will connect the receiver, transmitter, and the battery

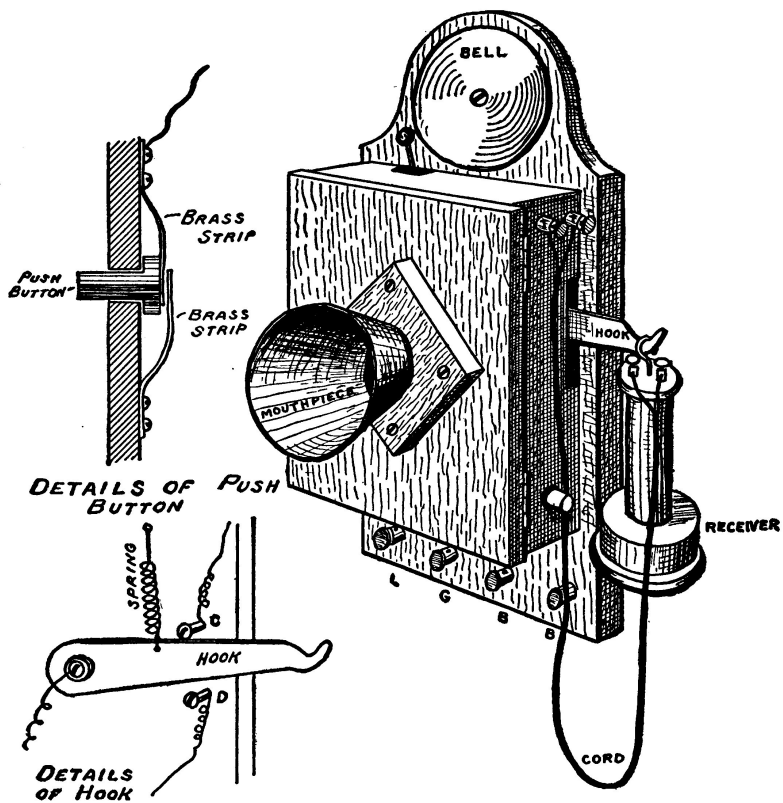
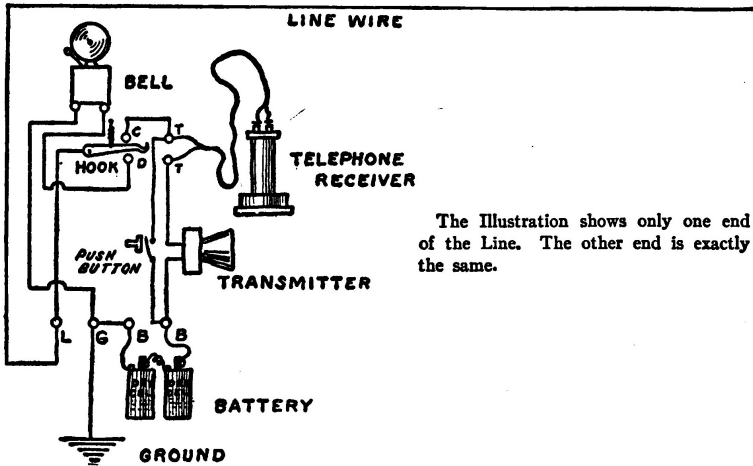

Fig. 149.—A Complete Telephone Instrument. Two Instruments such as this are necessary to form a simple Telephone System.



The Illustration shows only one end of the Line. The other end is exactly the same.

Fig. 150.—Diagram of Connection for the Telephone Instrument shown in Fig. 149.

to the line so that it is possible to talk. If, however, it is desired to ring the bell on the instrument at the other end of the line, all that it is necessary to do is to press the push-button. This will short-circuit the receiver and the transmitter and ring the bell. The battery current is flowing over the line all the time when the receiver is up, but the transmitter and the receiver offer so much resistance to its flow that not enough current can pass to ring the bell until the resistance is cut out by short-circuiting them with the push-button.

The instruments at both ends of the line should be similar. In connecting them together care should be taken to see that the batteries at each end of the line are arranged so that they are in series and do not oppose each other. One side of the line may be a wire, but the return may be the ground, as already explained in the chapter on telegraph apparatus.

A transmitter of the "desk-stand" type may be made according to the scheme shown in Figure 151. It consists simply of a transmitter mounted upon an upright, and provided with a base so that it may stand on a desk or a table.

It is also fitted with a hook and a push-button, so that it is a complete telephone instrument with the exception of the bell and the battery. The battery and the bell may be located in another place and connected to the desk-stand by means of a flexible wire or "electrical cord."

Figure 152 shows what is known as a telephone induction coil. Induction

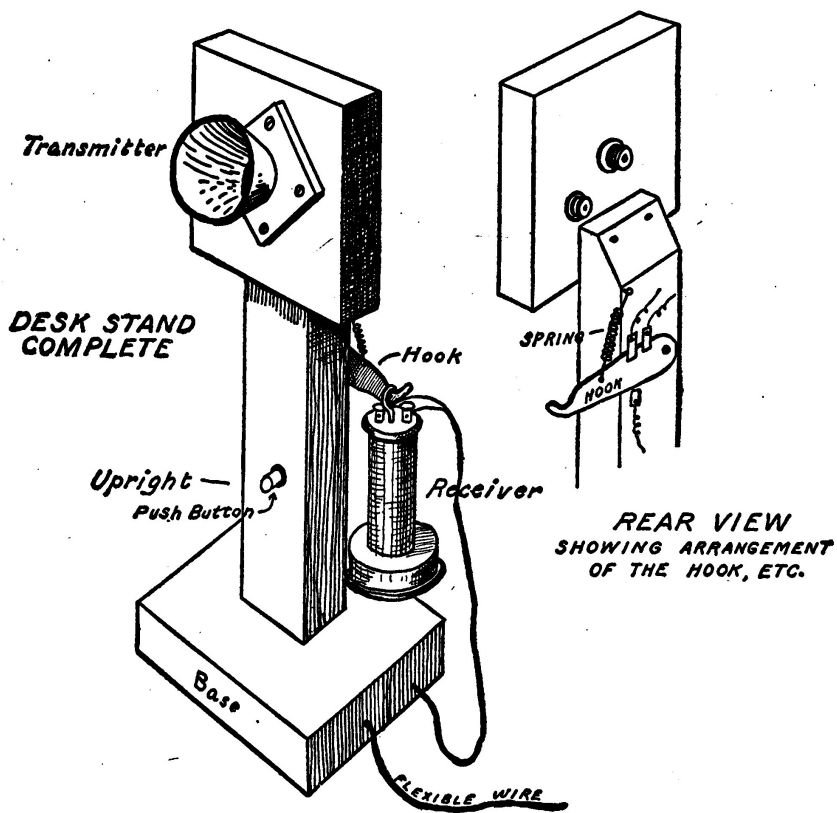

Fig. 151.—A Desk-Stand Type of Telephone.

coils are used in telephone systems whenever it is necessary to work over a long distance. Such a system is more complicated, and requires considerable care in making the connections, but is far superior to the system just described.

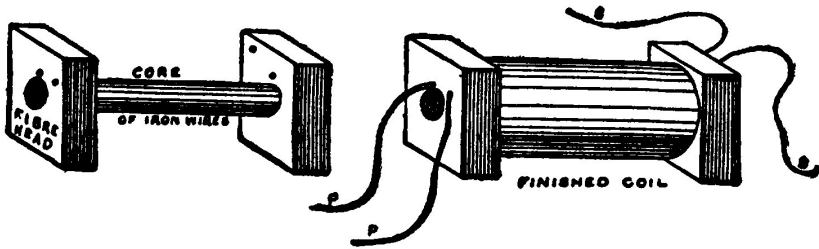

Fig. 152.—A Telephone Induction Coil.

An induction coil consists of two fiber or hard-wood heads, about one inch square and one-quarter of an inch thick, mounted on the ends of an iron core composed of a bundle of small iron wires about two and one-half inches long. The core should be about five-sixteenths of an inch in diameter.

The core is covered with a layer of paper and then wound with three layers of No. 22 B. & S. single-cotton-covered wire. These three layers of wire form the *primary*. The primary is covered with a layer of paper and then the secondary is wound on. The secondary consists of twelve layers of No. 36 B. & S. single-silk-covered magnet wire. It is advisable to place a layer of paper between layers of the secondary winding, and to give each one a coating of shellac. The two secondary terminals of the coil are led out through holes in the fiber head and kept separate from the primary terminals.

The wiring diagram of a telephone system using an induction coil at each station is shown in Figure 153. The speech sent over a line using an induction coil system is much clearer and more easily understood than that on a line not using such a device.

In building telephone instruments or connecting them up, care and accuracy will go a long way towards success. Telephony involves some very delicate and sensitive vibratory mechanical and electrical actions, and such instruments must be very carefully made.

CHAPTER XII INDUCTION COILS

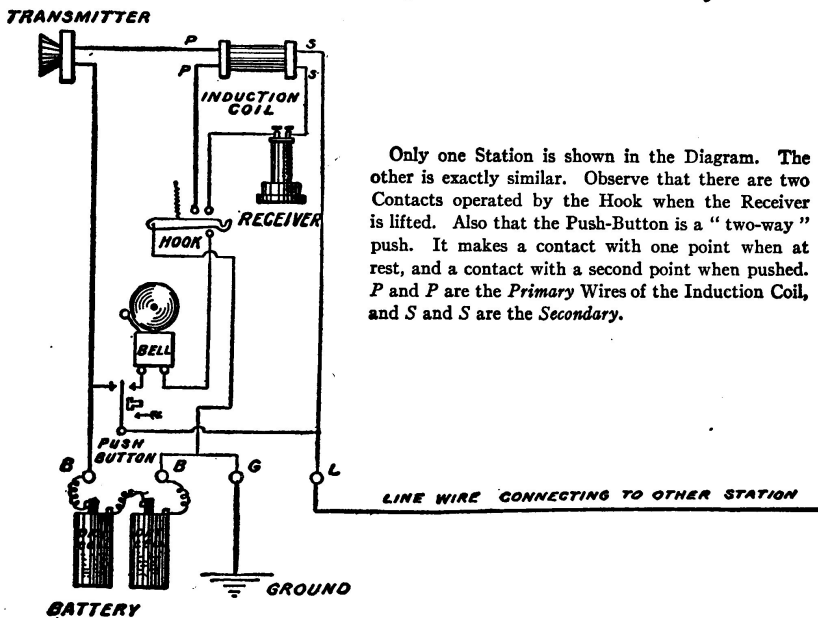

Only one Station is shown in the Diagram. The other is exactly similar. Observe that there are two Contacts operated by the Hook when the Receiver is lifted. Also that the Push-Button is a "two-way" push. It makes a contact with one point when at rest, and a contact with a second point when pushed. *P* and *P* are the *Primary* Wires of the Induction Coil, and *S* and *S* are the *Secondary*.

Fig. 153.—Diagram of Connection for a Telephone System employing an Induction Coil at each Station.

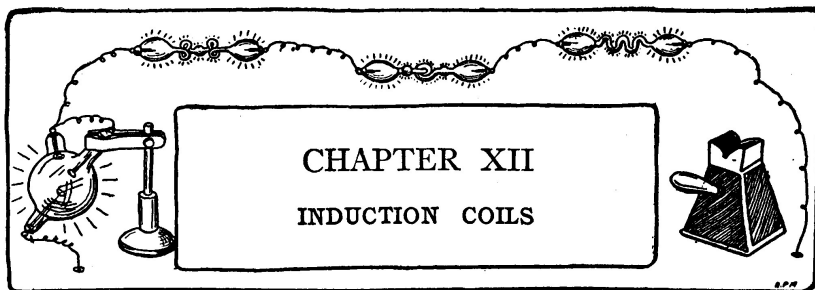

A Medical Coil or shocking coil, as it is properly termed, is nothing more or less than a small induction coil, and consists of a core, a primary winding, a secondary winding, and an interrupter. The principle of an induction coil and that of magnetic induction have already been explained in Chapter V. It might be well for the readers to turn back to pages 89-91 and reread them.

The human body possesses considerable resistance, and the voltage of one or two ordinary cells of battery is not sufficient to overcome that resistance and pass enough current through the body to be felt, unless under exceptional conditions.

The simplest means employable for raising the voltage of a battery high enough to produce a shock is the medical coil.

The first step in making such a coil is to roll up a paper tube, five-sixteenths of an inch in diameter inside, and two and one-half inches long. The outer end of the paper is carefully glued, so that it will not unroll. The tube is filled with pieces of iron wire two and one-half inches long which have been straightened by rolling between two boards. The size of the iron wire may vary from No. 20 to No. 24 B. & S. gauge. Enough should be slipped into the tube to pack it tightly and admit no more.

A square block, 1 x 1 x 5-16 inches, is cut out of fiber or a close-grained hard wood and a hole three-eighths of an inch in diameter bored through the center. One end of the tube containing the core is smeared with glue and slipped into the block. The end of the tube is allowed to project through about one-sixteenth of an inch. A second block, in the form of a circle three-quarters of an inch in diameter, one-quarter of an inch thick, and having a three-eighths of an inch hole through the center, is glued on the opposite end.

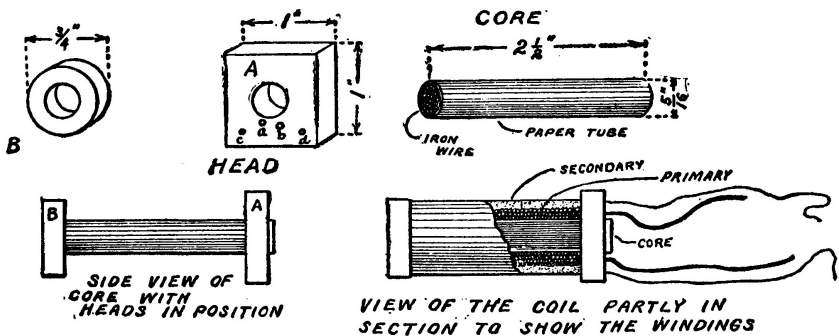

Fig. 154.—Details of Various Parts of a Medical Coil.

After the glue has dried, four small holes are drilled in the square head in the approximate positions shown by Figure 154. Four layers of No. 22 B. & S. gauge magnet wire (it may be either silk or cotton, double or single covered) is wound smoothly and carefully over the core. The terminals are led out of the holes *a* and *b*. The primary is covered with two or three layers of paper, and then enough secondary wound on to bring the total diameter of the coil to about eleven-sixteenths of an inch. The secondary wire must be much finer than the primary. It is possible to use any size from No. 32 to No. 36 B. & S. gauge and obtain good results. The insulation may be either single silk or single cotton.

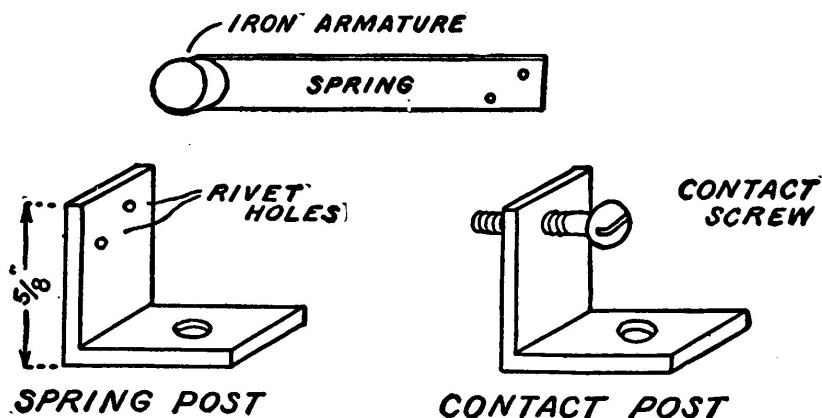

Fig. 155.—Details of Interrupter for Medical Coil.

The secondary terminals are led out through the holes *c* and *d*. It is perhaps a wise plan to re-enforce these leads with a heavier piece of wire, because otherwise they are easily broken.

The interrupter is a simple arrangement capable of being made in several different ways. The drawing shows an arrangement which can be improved upon by any experimenters who are familiar with a medical coil. I have shown the simplest arrangement, so that all my readers will be able to build it, and those who want to improve it can do so.

If a small piece of silver is soldered to the spring and to the contact-point it will give better results. The silver is easily secured by cutting up a ten-cent piece. One terminal of the primary is connected to the interrupter spring and the other to a binding-post. The contact-post is also connected to a binding-post. If a battery is connected to the two binding-posts, the current will flow from one post

through the coil to the interrupter spring, through the spring to the contact post, and thence back to the battery, making a complete circuit. As soon as the current flows, however, it produces magnetism which draws the spring away from the contact and breaks the circuit, cutting off the magnetic pull. The spring flies back to the contact but is drawn forward again immediately and repeats the operation continuously at a high rate of speed.

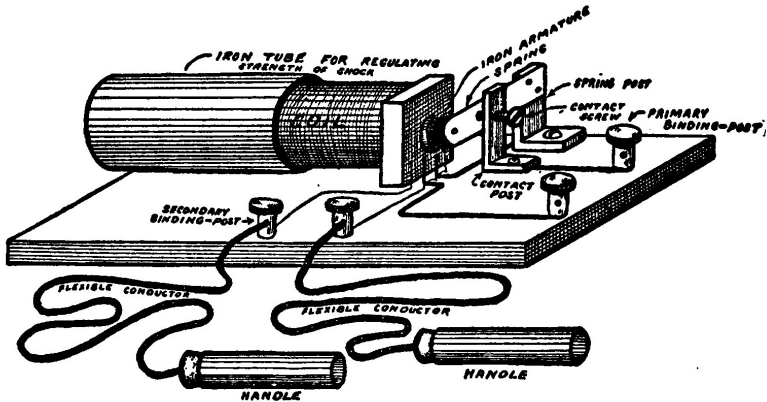

Fig. 156.—Completed Medical Coil.

The secondary terminals are led out to two binding-posts to which are connected two electrodes or handles by means of flexible wires. The electrode may be made of two ordinary flat strips of sheet-metal or a piece of tubing. In the latter case, the wires may be connected by wedging them in with a cork. If the handles are grasped while the battery is connected to the primary posts and the interrupter is in operation a powerful shock will be felt. The shock may be regulated from a weak current that can hardly be felt to a very powerful one by providing the coil with a piece of iron tubing of about seven-eighths of an inch inner diameter and two inches long which will slip on and off the coil. When the tube is all the way on, the shock is very mild, and when all the way off, the shock is very strong. Of course any intermediate strength may be secured at stages between the two extremes.

The current from medical coils is often prescribed by physicians for rheumatism and nervous disorders, but must be properly applied. The coil just described is harmless. It will give a strong shock, but the only result is to make the person receiving it drop the handles and not be anxious to try it again.

Spark-Coils

A "spark-coil" is one of the most interesting pieces of apparatus an experimenter can possess. The experiments that may be performed with its aid are varied and many.

The purpose of a "spark-coil" is to generate enormously high voltages which are able to send sparks across an air space that ordinary currents of low voltage could not possibly pierce. The spark-coil is the same in principle as the small induction coils used as medical or shocking coils, but is made on a larger scale and is provided with a condenser connected across the terminals of the interrupter.

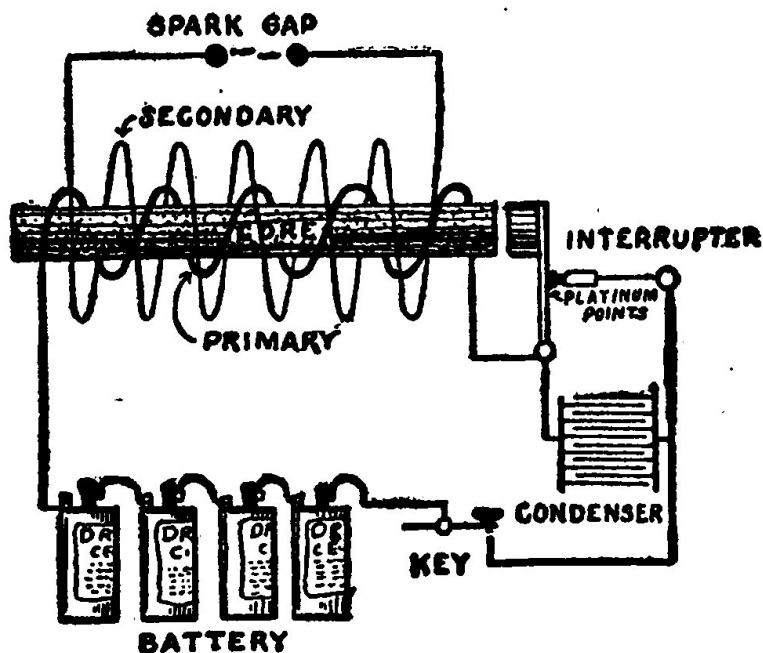

Fig. 157.—Diagram showing Essential Parts of Induction Coil.

It consists of a central iron core surrounded by a coil of heavy wire called the "primary," and by a second outside winding of wire known as the "secondary."

The primary is connected to a few cells of battery in series with an interrupter. The interrupter makes and breaks the circuit, i. e., shuts the current on and off repeatedly.

Every time that the current is "made" or broken, a high voltage is induced in the secondary. By means of the condenser connected across the interrupter terminals, the current at "make" is caused to take a considerable fraction of time to grow, while at "break," the cessation is instantaneous. The currents induced in the secondary at break are so powerful that they leap across the space in a brilliant torrent of sparks.

Building a Spark-Coil

Perhaps more attempts are made by experimenters to construct a spark-coil than any other piece of apparatus, and the results are usually poor. A spark-coil is not hard to construct, but it requires careful work and patience. It is not a job to be finished in a day, but time must be liberally expended in its construction. Satisfactory results are easily obtained by any one of ordinary mechanical ability if patience and care are used.

Parts for spark-coils are for sale by many electrical houses, and it is possible to purchase a set of such machine-made parts for less than the separate materials usually cost.

For the benefit of those who might wish to build a larger coil than the one described in the following text, a table showing the dimensions of two other sizes will be found.



Fig. 158.—Empty Paper Tube, and Tube filled with Core Wire preparatory to winding on the Primary.

The core is made of very soft iron wire about No. 20 or 22 B. & S. gauge, cut to exact length. Each piece should be six inches long. Iron wire may be purchased from electrical supply houses already cut to various lengths for twenty cents a pound. In view of the amount of labor required carefully to cut each piece to length and then straighten it out so that it will form a neat bundle, it is cheaper to purchase the wire already cut. Such wire has been annealed, i.e., softened by bringing to a red heat and then cooling slowly. In case the wire is purchased at a plumbing shop or a hardware store it must be annealed before it can be used.

This is accomplished by tying the wire in a compact bundle and placing it in a wood fire where it will grow red-hot. When this stage is reached, cover the wire with ashes and allow the fire to die away.

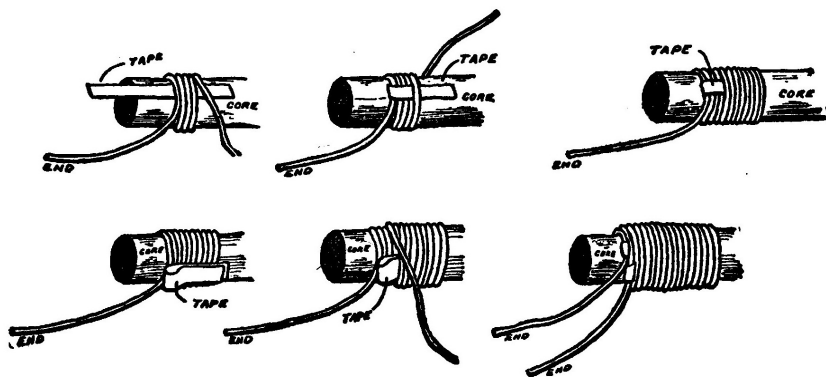

Fig. 159.—Illustrating the Various Steps in winding on the Primary and fastening the Ends of the Wire.

Cut a piece of tough wrapping paper into strips six inches long and about five inches wide. Wrap it around a stick or metal rod one-half of an inch in diameter, so as to form a tube six inches long and having a diameter of one-half of an inch. Glue the inside and outside edges of the paper so that the tube cannot unroll and then slip it off the stick.

Fill the tube with the six-inch wires until it is packed tightly and no more can be slipped in.

The primary consists of two layers of No. 18 B. & S. gauge cotton-covered wire wound over the core for a distance of five inches. One-half pound of wire is more than enough for one primary. The wire must be wound on very smoothly and carefully. In order to fasten the inside end so that it will not become loose, place a short piece of tape lengthwise of the core and wind on two or three turns over it. Then double the end back and complete the winding. After the first layer is finished, give it a coat of shellac and wind on the second layer. The end of the wire is wound with a piece of tape and fastened by slipping through a loop of tape embedded under the last few turns. The illustrations will explain more clearly just how this is accomplished. The second layer is then given a coat of shellac and allowed to dry. After it is dry, wrap about fifteen layers of paper which have been soaked in paraffin around the primary. This operation should be performed

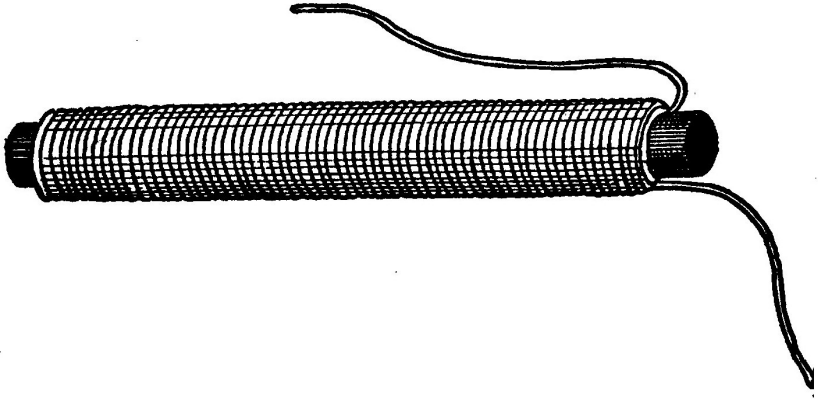

Fig. 160.—Complete Primary Winding and Core.

in a warm place, over a fire or lighted lamp where the paraffin may be kept soft, so that the paper will go on tightly.

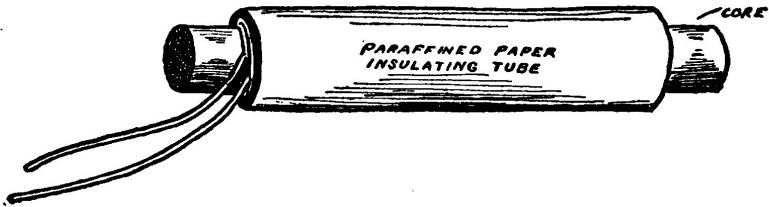

Fig. 161.—The Primary covered with Insulating Layer of Paper ready for the Secondary.

The coil is now ready to receive the secondary winding. The core and primary which have been described are suit-able for a secondary giving sparks from one-half to three-fourths of an inch long.

The secondary winding consists of several thousand turns of very fine wire wound on in smooth even layers with paper between each two layers.

The following table shows the size and amount of wire required. In addition, about two pounds of paraffin and a pad of linen paper or typewriter paper will be required. The wire may be either enamel, cotton, or silk insulated. Single

silk-covered wire is preferred.

SIZE OF COIL	SIZE OF WIRE	AMOUNT
1/2 inch	36 B. & S.	10 ounces
1 inch	34 B. & S.	1 lb.
1/2 inch	34 B. & S.	2 lbs.

The means for supporting and turning the coil in order to wind on the secondary may be left somewhat to the ingenuity of the young experimenter. The following suggestion, however, is one which experience has proved to be well worth following out, and may be applied to other things than the construction of an induction coil. It seems to be the nature of most boys, for some reason or other, to be unwilling to spend time and labor on anything which will aid them in their work. They are always in such a hurry and so anxious to see something completed that they direct all their energy to that end rather than spend part of their time in constructing some little device which would really lighten the other work and go a long way towards insuring its successful completion.

I have frequently given instructions for building an induction coil and placed particular stress upon winding the secondary, only to have such suggestions ignored in the anxious endeavor of boys to finish the coil as soon as possible. In every such instance the coil has been a failure.

The illustration shows a simple form of winder, with which the operation of winding the secondary is a very slow one, but, on the other hand, it is possible to do very accurate, careful winding with the aid of such a device. The parts may all be made from wood.

The chucks fit tightly over the ends of the core so that when the handle is turned, the coil will revolve also. The spring serves to keep the chucks snugly against the coil ends, so that they will not slip.

From one-half to five-eighths of a pound of wire will be required to wind the coil. A large number of strips of thin paraffined or waxed paper must be cut five inches wide. The inside terminal, or "beginning" end of the wire is tied around the insulating tube near the left-hand end. The spool of wire must be placed in a position where it will revolve freely without strain on the wire. No. 36 is very fine and easily broken, so use the utmost care to guard against this mishap.

Wind on a smooth, even layer of wire, permitting each turn to touch the other, but none to lap over. Carry the winding to within one-half inch of the ends

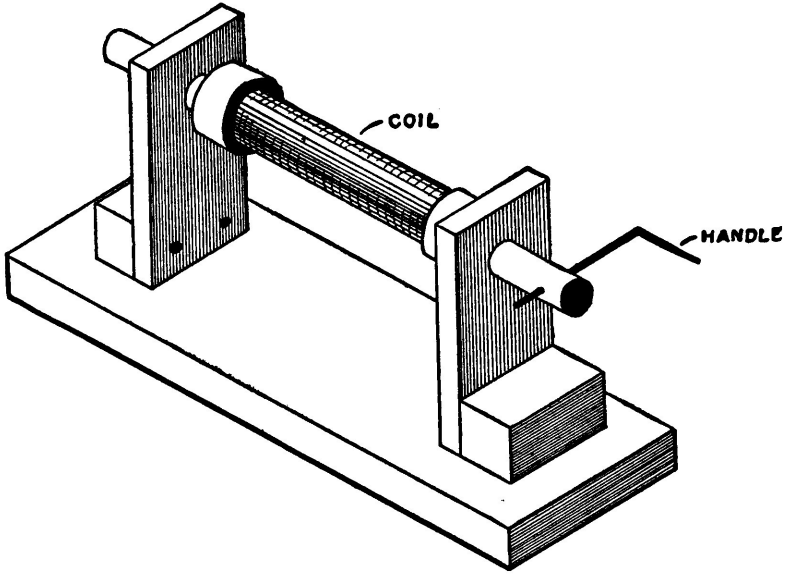

Fig. 162.—Simple Winding Device for winding the Secondary.

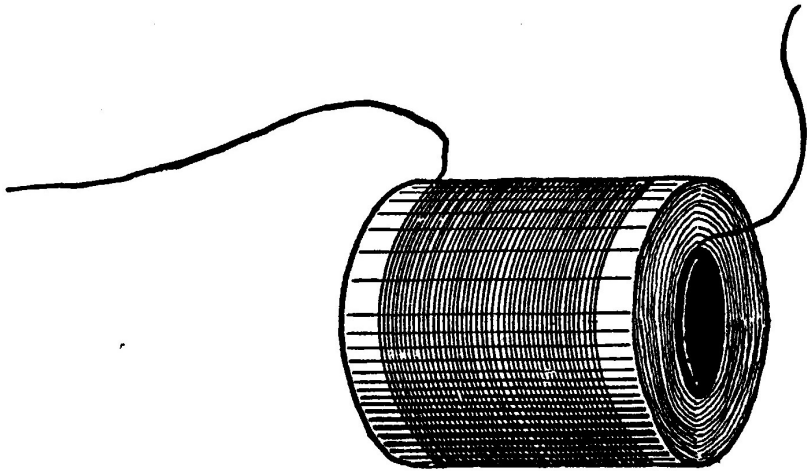

Fig. 163.—Completed Secondary Winding.

of the insulating tube and then wind on two layers of the waxed paper.

The paper must be put on smoothly and evenly, so as to afford a firm foundation for the next layer. The wire is wrapped around with the paper, so that the next layer starts one-half inch from the edge. A second layer is then wound on very carefully, stopping when it comes one-half inch from the edge. Two more layers of paper are put on, and the process repeated, alternately winding on paper and wire until the stated quantity of the latter has been used up. The layers of wire may occasionally be given a coating of shellac. This is a good insulator, and will serve to hold them together and prevent the wire from becoming loose.

In winding the coil, remember that if at any point you allow the winding to become irregular or uneven, the irregularity will be much exaggerated on the succeeding layers. For this reason, do not allow any to occur. If the wire tends to go on unevenly, wrap an extra layer of thick paper around underneath so as to offer a smooth foundation, and you will find the difficulty remedied.

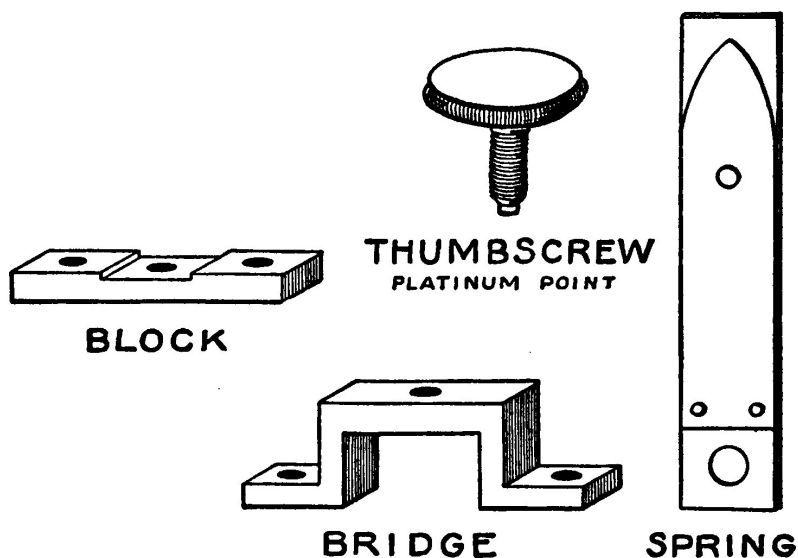

Fig. 164.—Interrupter Parts.

An efficient vibrator for a coil cannot be easily made, and it is best to buy one which is already fitted with platinum points. The interrupter will play a very important part in the successful working of the coil, and its arrangement

and construction are important. Interrupters like that shown in the illustration and used for automobile will be found the best.

The condenser may be home-made. It consists of alternate sheets of tinfoil and paraffined paper, arranged in a pile as shown in the illustration. The following table gives the proper sizes for condensers for three different coils.

SIZE OF SPARK-COIL	TINFOIL	
	NO. SHEETS	SIZE OF SHEETS
1/2 inch	50	2 x 2
1 inch	100	7 x 5
1 1/2 inch	100	8 x 6

The paper must be about one-half inch larger all the way around, so as to leave a good margin. The alternate sheets of tinfoil, that is, all on one side and all on the other, are connected.

The condenser is connected directly across the terminals of the interrupter.



Fig. 165.—Condenser.

There are various methods of mounting a coil, the most common being to place it in a box with the interrupter at one end. Perhaps, however, one of the neatest and also the simplest methods is to mount it in the manner shown in the

illustration.

The end-pieces are cut out of wood. No specific dimensions can be given, because the diameter of the coils will vary somewhat according to who winds them and how tightly they are made. The coil is enclosed in a tube made by rolling up a strip of cardboard and then giving it a coat of shellac. The tube may be covered by a strip of black cloth, so as to improve its appearance.

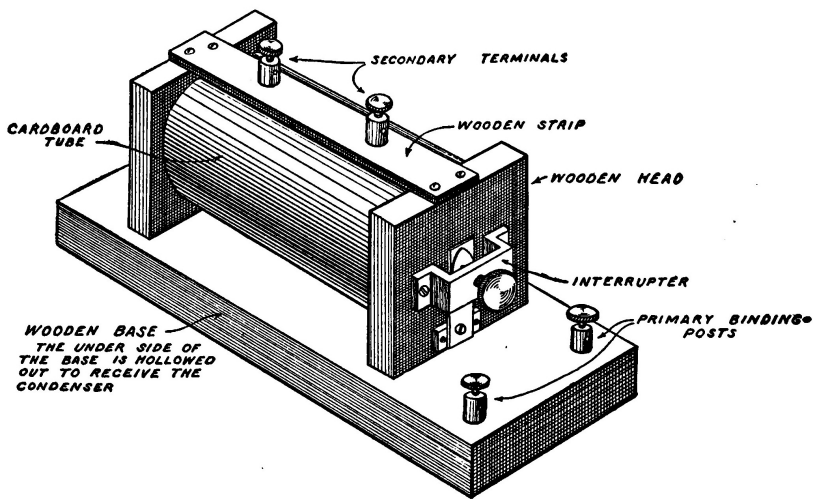

Fig. 166.—Completed Coil.

The vibrator is mounted on the end. The core projects through a hole in the wood near the end of the vibrator spring so that the latter will be drawn in by the magnetism of the core when the current flows. The condenser may be placed in the hollow box which forms the base of the coil.

The secondary terminals of the coil are mounted on a small strip of wood bridging the two coil ends.

One terminal of the primary is connected to a binding-post mounted on the base, and the other led to the vibrator spring. The vibrator yoke is connected to a second binding-post on the base. One terminal of the condenser is connected to the spring, and the other to the yoke.

Four cells of dry battery should be sufficient to run the coil and cause it to give a good one-half-inch spark if built according to the directions here given. The vibrator or interrupter will require adjusting and a position of the adjusting

screw will soon be found where the coil works best.

Experiments with a Spark-Coil

Electrical Hands. Many extraordinary and interesting experiments may be performed with the aid of a spark-coil.

The following experiment never fails to amuse a party of friends, and is mystifying and weird to the ordinary person, unacquainted with the secret of its operation.

Figure 167 shows the arrangement of the apparatus. The primary of an ordinary one-inch spark induction coil is connected in series with a twelve-volt battery and telephone transmitter. A small switch is included in the circuit to break the current and prevent needless waste of the battery when the apparatus is not in immediate use. The secondary terminals of the induction coil are led by means of an insulated wire to the adjoining room where they terminate in a pair of scissors, or some other small metallic object which may be clasped in the hand.

Each of two persons, wearing dry shoes or rubber-soled slippers, grasps the terminal of one wire in one hand. The other hand is placed flat against the ear of a third person, with a piece of dry linen paper intervening between the hands and the head. If a fourth person, in the room where the induction coil is located, then closes the small switch and speaks into the telephone transmitter, the person against whose ears the hands are being held will hear the speech very distinctly. The ticking of a watch held against the mouthpiece of the transmitter will be heard with startling clearness.

The principle governing the operation of the apparatus is very simple. Almost every experimenter is familiar with the ordinary electrical condenser, which consists of alternate sheets of paraffined paper and tinfoil. When this is connected to a source of electricity of high potential, but not enough so as to puncture the paper dielectric, the alternate sheets of tinfoil will become oppositely charged and attract each other. If the circuit is then broken the sheets will lose their charge and also their attraction for one another. If the tinfoil sheets and paper are not pressed tightly together, there will be a slight movement of the tinfoil and paper which will correspond in frequency to any fluctuations of the charging current which may take place.

The head of the third person and the hands held against his head act like three tinfoil sheets of a condenser, separated by two sheets of paper. The words spoken in the transmitter cause the current to fluctuate and the induction coil raises the potential of the current sufficiently to charge the condenser and cause a slight vibration of the paper dielectric. The vibrations correspond in strength

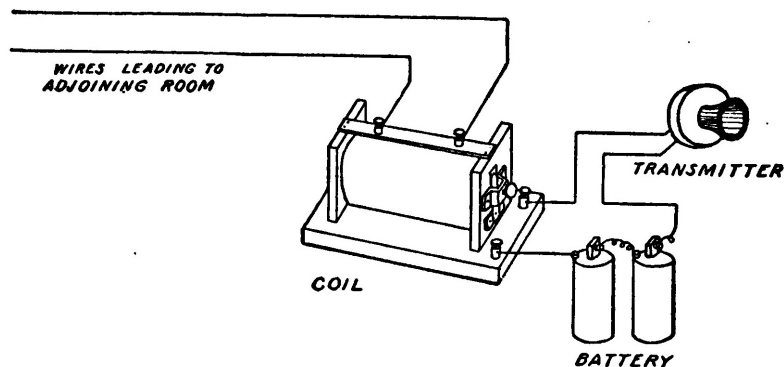

Fig. 167.—Diagram showing how to connect the Apparatus for the "Electric Hands" Experiment.

and speed to those of the voice, and so the words spoken in the transmitter are audible to the person over whose ears the paper is pressed.

Everything about the apparatus must be as dry as possible, to insure its successful operation. The people holding the wires in their hands should stand on a carpeted floor. Always be very careful to tighten the adjusting screw and block the interrupter on the coil, so that by no means can it possibly commence to operate, or the person listening, instead of "hearing things" will become the victim of a rather painful, practical joke.

Geissler Tubes

The most beautiful and surprising effects may be obtained by lighting Geissler tubes with a coil. The tubes are made in intricate and varied patterns of special glass, containing fluorescent minerals and salts, and are filled with different rarefied gases. When the tubes are connected to the secondary of a spark-coil by means of a wire fastened to the little rings at the end, and the coil is set in operation, they light up in the most wonderful way imaginable. The rarefied gases and minerals in the glass throw out beautiful iridescent colors, lighting up a dark room with a weird flickering light. Every tube is usually of a different pattern and has a combination of different colors. The most beautiful tubes are those provided with a double wall containing a fluorescent liquid, which heightens the color effects when the tube is lighted.

Eight to ten tubes may be lighted at once on an ordinary coil by connecting

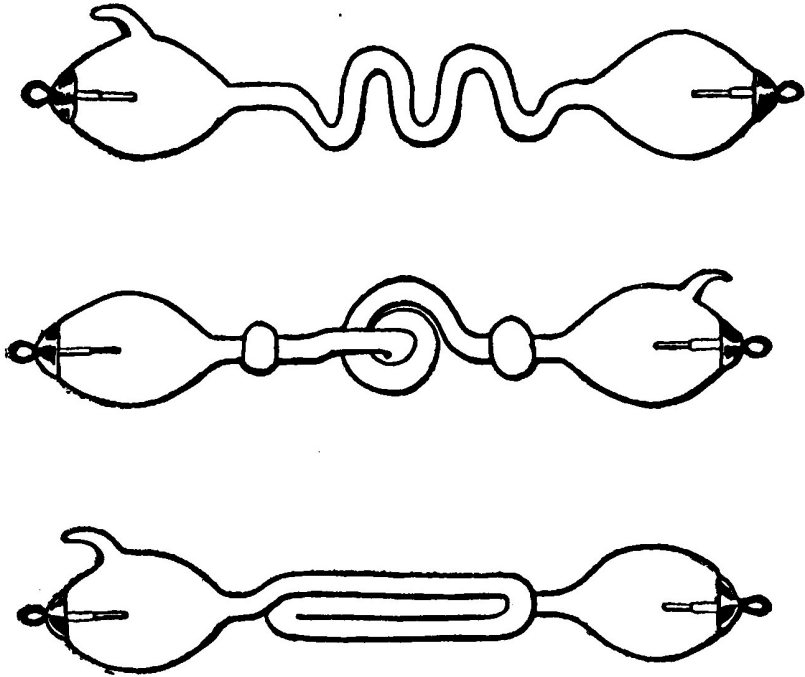

Fig. 168.—Geissler Tubes.

them in series.

Ghost Light

If you grasp the bulb of an old incandescent electric lamp in one hand and touch the base to one side of the secondary when the coil is in operation the bulb will emit a peculiar greenish light in the dark.

Puncturing Paper

If you place a piece of heavy paper or cardboard between two sharp wires connected to the secondary of a spark-coil and start the coil working, the paper will be pierced.

A Practical Joke

This action of the coil may be made the basis of an amusing joke. Offer a friend who may smoke cigarettes some cigarette paper which has been prepared in the following way.

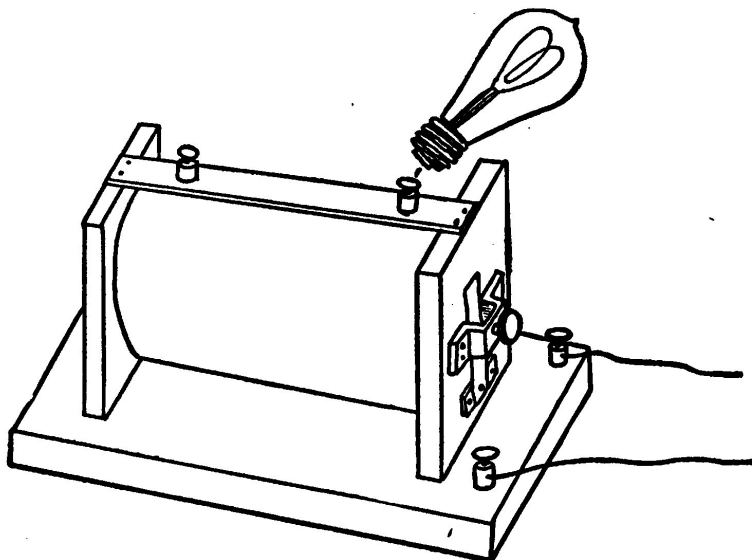

Fig. 169.—The Bulb will emit a Peculiar Greenish Light.

Place several sheets of the paper on a piece of sheet-metal which is connected to one side of the secondary. By means of an insulated handle so that you will not get a shock, move the other wire all over the surface of the cigarette paper. The paper will be pierced with numerous fine holes which are so fine that they can hardly be seen.

If your friend uses any of the paper in making a cigarette and tries to light it he will waste a box of matches without being able to get one good puff, because the little invisible holes in the paper will spoil the draft. Perhaps he may quit smoking altogether.

An Electric Garbage-can

If there are any dogs in your neighborhood that have a habit of extracting

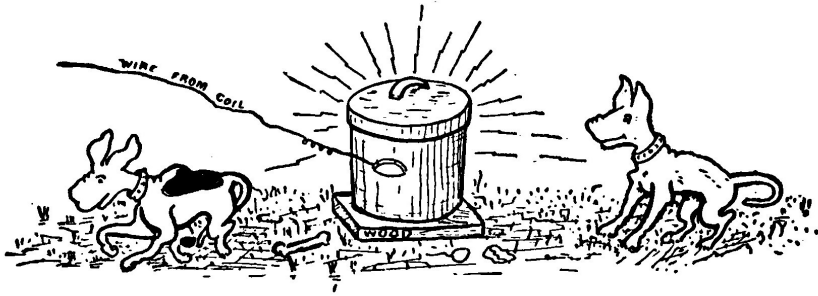

Fig. 170.—An Electrified Garbage-can.

things from your ash-barrel or garbage-can, place the latter on a piece of dry wood. Lead a well insulated wire from one secondary terminal of your coil to the can. Ground the other secondary terminal. If you see a dog with his nose in the can press your key and start the coil working. It will not hurt the dog, but he will get the surprise of his life. He will go for home as fast as he can travel and will not touch that particular can again, even if it should contain some of the choicest canine delicacies.

Photographing an Electric Discharge

The following experiment must be conducted in a dark room with the aid of a ruby photographic lamp, as otherwise the plates used would become lightstruck and spoiled.

Place an ordinary photographic plate on a piece of sheet-metal with the coated side of the plate upwards. Connect one of the secondary terminals of the spark-coil to the piece of sheet-metal.

Then sift a thin film of dry starch powder, sulphur, or talcum through a piece of fine gauze on the plate. Lead a sharp-pointed wire from the other secondary terminal of the coil to the center of the plate and then push the key just long enough to make one spark.

Wipe the powder off the plate and develop it in the usual manner of films and plates. If you cannot do developing yourself, place the plate back in its box and send it to some friend, or to a photographer.

The result will be a negative showing a peculiar electric discharge, somewhat like sea-moss in appearance. No two such photographs will be alike and the greatest variety of new designs, etc., imaginable may be produced in this manner.

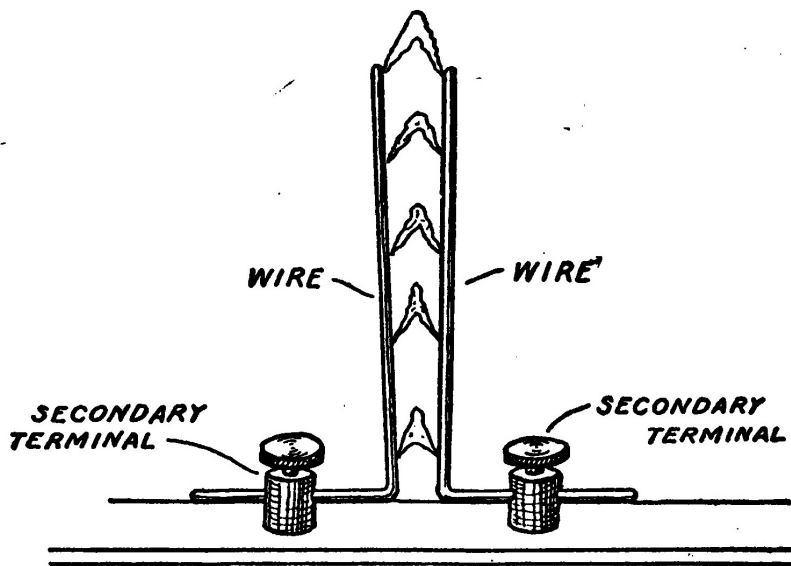

Fig. 171.—Jacob's Ladder.

Jacob's Ladder

Take two pieces of bare copper wire about eight inches long and bend them at right angles. Place them in the secondary terminals of a spark-coil as in Figure 171. Bend them so that the vertical portions are about one-half of an inch apart at the bottom and one inch apart at the top. Start the coil working, and the sparks will run up the wires from the bottom to the top and appear very much like the rungs in a ladder.

X-Rays

Most young experimenters are unaware what a wonderful and interesting field is open to the possessor of a small X-ray tube.

Small X-ray tubes which will operate satisfactorily on an inch and one-half spark-coil may be obtained from several electrical supply houses. They usually cost about four dollars and a half. With such a tube and a *fluoroscope* it is possible to see the bones in the human hand, the contents of a closed purse, etc.

The tube is made of glass and contains a very high vacuum. The long

end of the tube contains a platinum electrode called the *cathode*. The short end contains two electrodes called *anodes*, one perpendicular to the tube and the other diagonal.

The tube is usually clamped in a wooden holder called an X-ray tube stand. The tube should be so adjusted that the X-rays which are reflected from the diagonal anode will pass off in the direction shown by the dotted lines in Figure 174.

The fluoroscope is a cone-shaped wooden box fitted with a screen composed of a sheet of paper covered with crystals of a chemical called platinum-barium-cyanide.

The opposite end of the box is fitted with a covering of felt or velvet which shuts off the light around the eyes and nose when you look into the fluoroscope and hold it tightly against the face.

A fluoroscope may be purchased complete, or the platinum-barium-cyanide screen purchased separately and mounted on a box as shown in Figure 173.

The two anodes of the tube should be connected, and led to one terminal of a spark-coil capable of giving a spark at least one and one-half inches long. Another wire should be led from the cathode of the tube to the other terminal of the coil.

When it is desired to inspect any object, such as the hand, it must be held close to the screen of the fluoroscope and placed between the latter and the tube in the path of the X-rays. The X-rays are thrown forth from the tube at an angle of 45 degrees from the diagonal anode.

Look into the fluoroscope and it should appear to be filled with a green light. If not, the battery terminals connected to the primary of the coil should be reversed, so as to send the current through in the opposite direction.

The X-rays will cause the chemicals on the screen to light up and give forth a peculiar green light. If the hand is held against the screen, between the screen and the tube, the X-rays will pass through the hand and cast a shadow on the screen. They do not pass through the bones as easily as they do through the flesh and so will cast a shadow of the bones in the hand on the screen, and if you look closely you will be able to see the various joints, etc. The interrupter on the coil should be carefully adjusted so that the light does not flicker too much.

If it is desired to take X-ray pictures, a fluoroscope is unnecessary.

Turn the tube around so that the X-rays point downward.

Shut the battery current off so that the tube is not in operation until everything else is ready.

Place an ordinary photographic plate, contained in an ordinary plate-holder, directly under the tube with the gelatin side of the plate upwards.

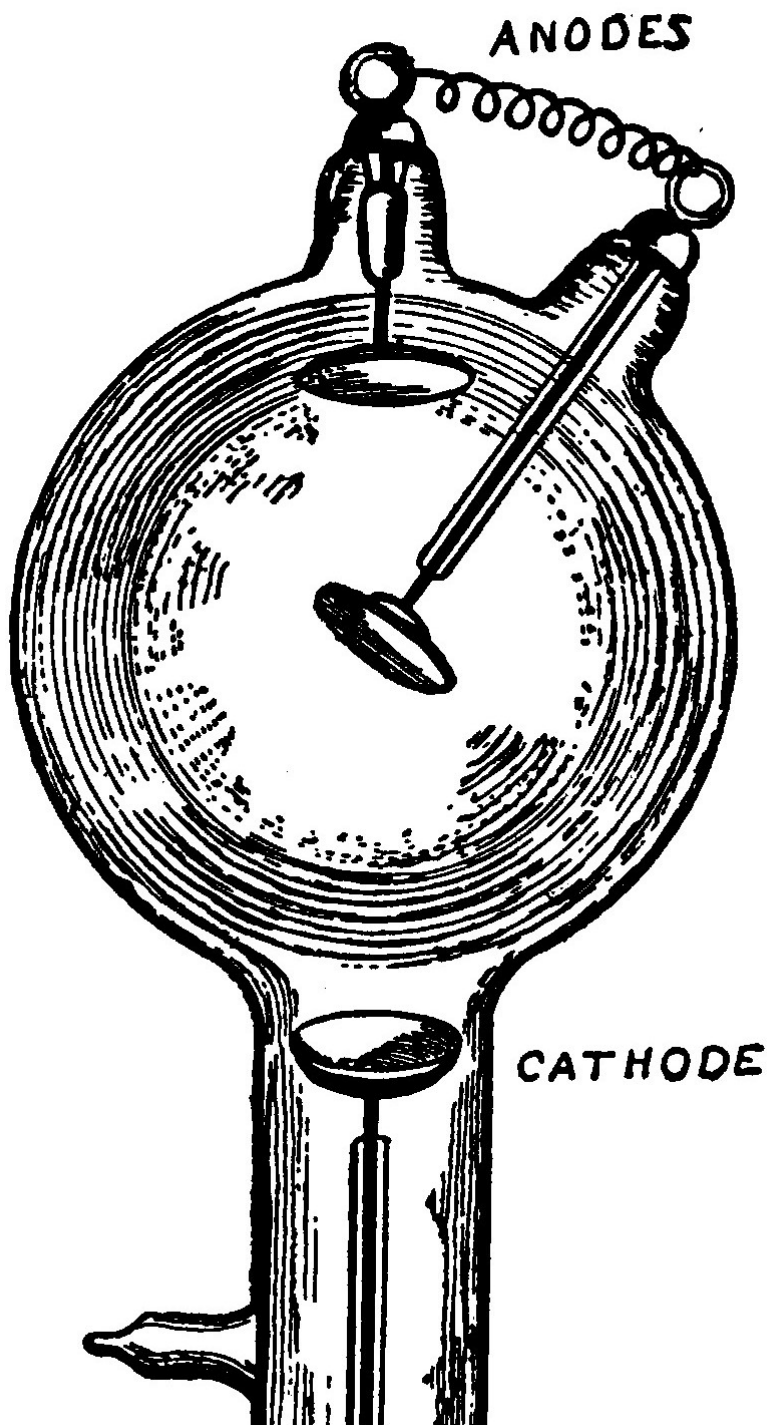

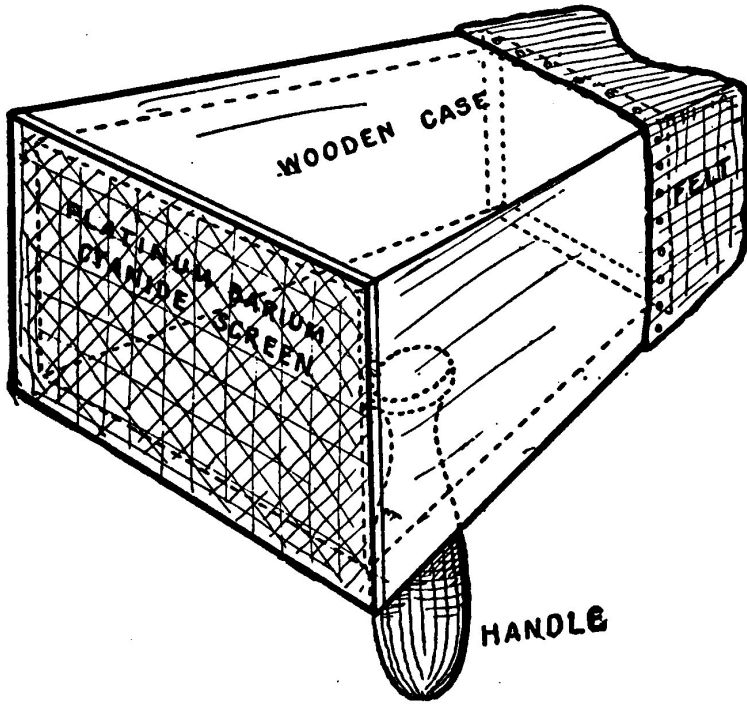

Fig. 173.—Fluoroscope.

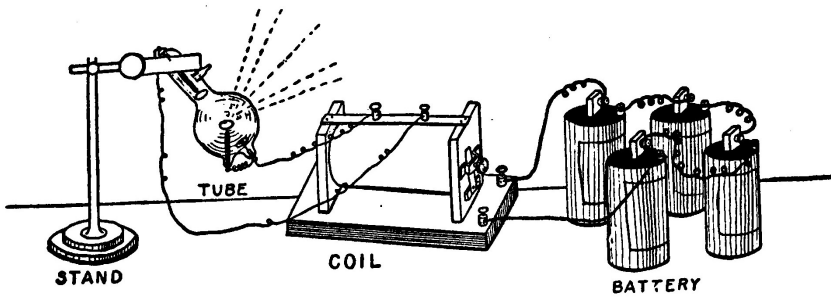

Fig. 174.—How to connect an X-Ray Tube to a Spark-Coil.

Place the hand flat on the plate and lower the tube until it is only about three inches above the hand. Then start the coil working so that the tube lights up and permit it to run for about fifteen minutes without removing the hand. Then turn the current off and develop the plate in a dark room.

It is possible to obtain a very good X-ray photograph of the hand in this manner. Photographs showing the skeleton of a mouse, nails in a board, coins in a purse, a bullet in a piece of wood, etc., are a few of the other objects which make interesting pictures.

CHAPTER XIII TRANSFORMERS

In most towns and cities where electricity for light and power is carried over long distances, it will be noticed that small iron boxes are fastened to the poles at frequent intervals, usually wherever there is a group of houses or buildings supplied with the current. Many boys know that the boxes contain "transformers," but do not quite understand exactly what their purpose is, and how they are constructed.

When it is desired to convey electrical energy to a distance, for the purpose of producing either light or power, one of the chief problems to be faced is, how to reduce to a minimum any possible waste or loss of energy during its transmission. Furthermore, since wires and cables of large size are very costly, it is desirable that they be as small as possible and yet still be able to carry the current without undue losses.

It has already been explained that wires offer resistance to an electrical current, and that some of the energy is lost in passing through a wire because of this resistance. Small wires possess more resistance than large ones, and if small wires are to be used, in order to save on the cost of the transmission line, the loss of energy will be greater, necessitating some method of partially reducing or overcoming this fault.

In order to explain clearly how the problem is solved, the electric current may for the moment be compared to a stream of water flowing through a pipe.

The illustration shows two pipes, a small one and a large one, each supposed to be connected to the same tank, so that the pressure in each is equal, and it is clearly apparent that more water will flow out of the large one than out of the small one. If ten gallons of water flow out of the large pipe in one minute, it may be possible that the comparative sizes of the pipes are such that only one gallon of water will flow out of the small one in the same length of time.

But in case it should be necessary or desirable to get ten gallons of water a minute out of a small pipe such as *B*, what could be done to accomplish it?

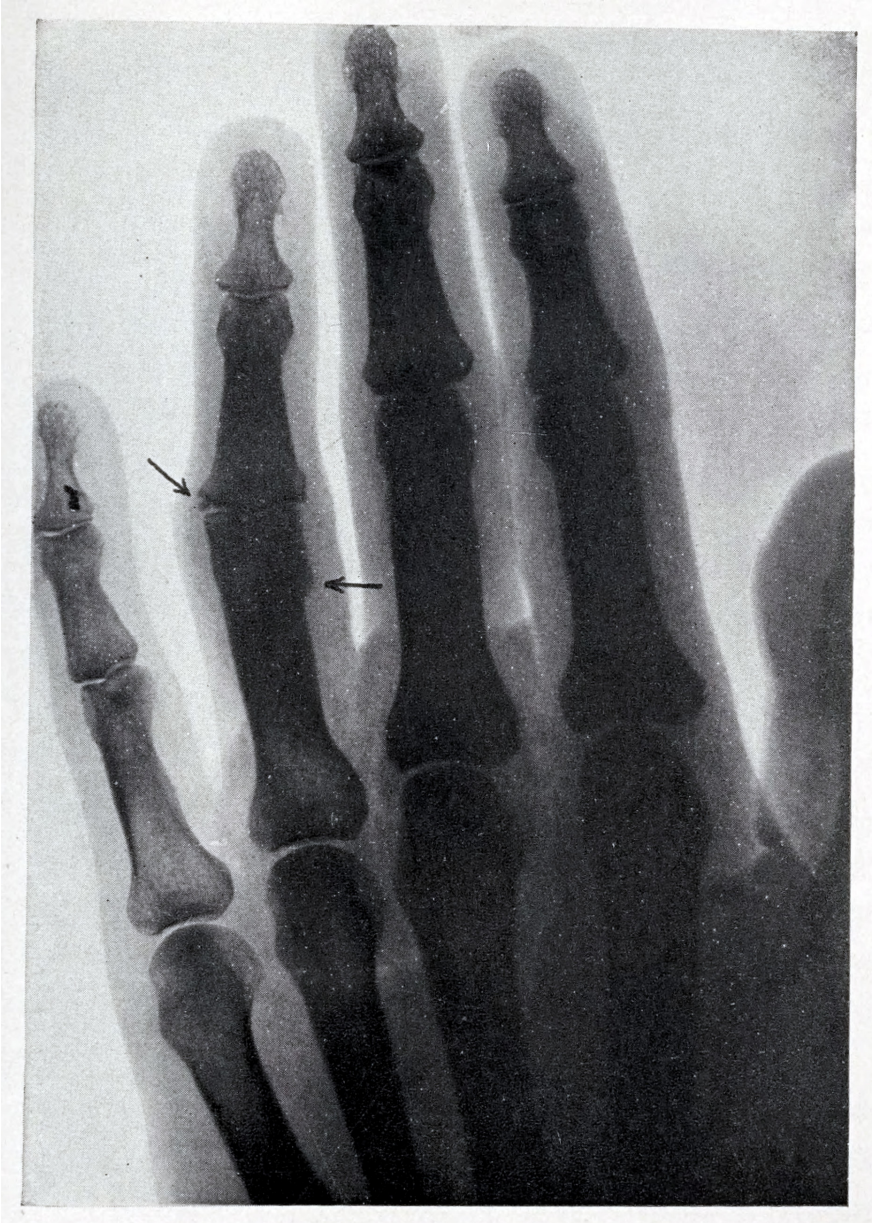

An X-Ray Photograph of the hand taken with the Outfit shown in Figure 174. The arrows point to injuries to the bone of the third finger near the middle Joint Resulting in a Stiff Joint.

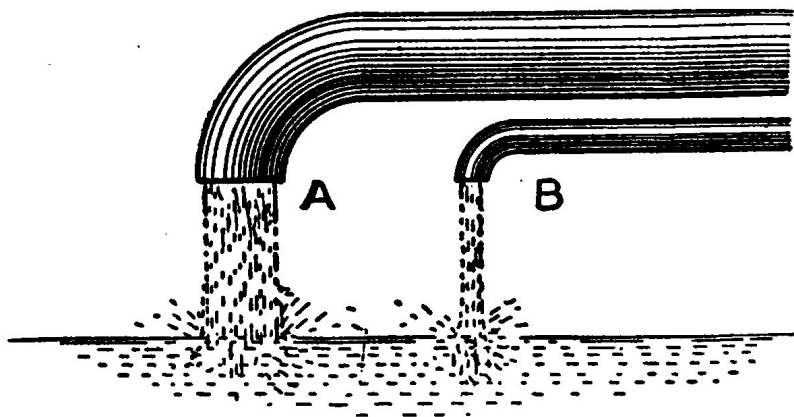
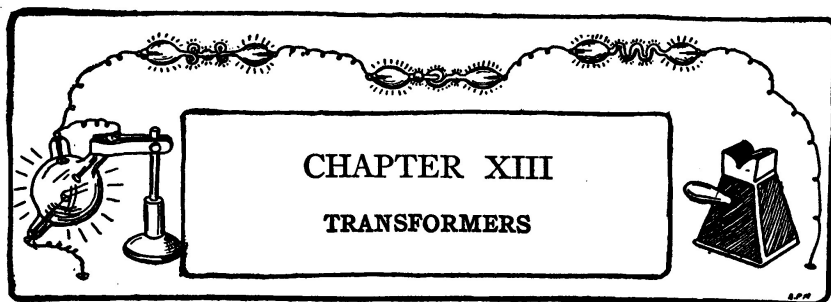

Fig. 175.—Comparison between Electric Current and Flow of Water.

The pressure could be increased. The water would then be able better to overcome the resistance of the small pipe.

This is exactly what is done in the distribution of electric currents for power and lighting. The pressure or potential is increased to a value where it can overcome the resistance of the small wires.

But unfortunately it rarely happens that electrical power can be utilized at high pressure for ordinary purposes. For instance, 110 volts is usually the maximum pressure required by incandescent lamps, whereas the pressure on the line wires issuing from the power-house is generally 2,200 volts or more.

Such a high voltage is hard to insulate, and would kill most people coming into contact with the lines, and is otherwise dangerous.

Before the current enters a house, therefore, some apparatus is necessary, which is capable of reducing this high pressure to a value where it may be safely employed.

This is the duty performed by the "transformer" enclosed in the black iron box fastened on the top of the electric light poles about the streets.

If a transformer were to be defined it might be said to be a device for changing the voltage and current of an *Alternating* circuit in pressure and amount.

The word, *alternating*, has been placed in italics because it is only upon alternating currents that a transformer may be successfully employed. Therein, also, lies the reason why alternating current is supplied in some cases instead of direct current. It makes possible the use of transformers for lowering the voltage at the point of service.

Many boys possessing electrical toys and apparatus operating upon direct current only, have bemoaned the fact that the lighting system in their town furnished alternating current. Very often in the case of small cities or towns one power-house furnishes the current for several communities and the energy has to be carried a considerable distance. Alternating current is then usually employed.

The illustration shows the general method of arranging such a system. A large dynamo located at the power-house generates alternating current. The alternating current passes into a "step-up" transformer which raises the potential to 2,200 volts (approximately). It is then possible to use much smaller line wires, and to transmit the energy with smaller loss than if the current were sent out at the ordinary dynamo voltage. The current passes over the wires at this high voltage, but wherever connection is established with a house or other building, the "service" wires which supply the house are not connected directly to the line wires, but to a "step-down" transformer which lowers the potential of the current flowing into the house to about 110 volts.

In larger cities where the demand for current in a given area is much greater

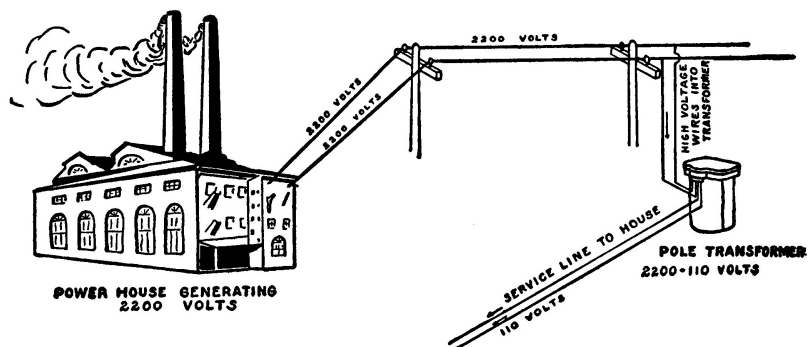

Fig. 176.—Alternating Current System for Light and Power.

than that in a small town, a somewhat different method of distributing the energy is employed.

The alternating current generated by the huge dynamos at the "central" station is passed into a set of transformers which in some cases raise the potential as high as five or six thousand volts. The current is then sent out over cables or "feeders" to various "sub" stations, or "converter" stations, located in various parts of the city. Here the current is first sent through a set of step-down transformers which reduce the potential to the approximate value originally generated by the dynamos. It then passes into the "rotary converters" which change the alternating current into direct current after which it is sent by underground cables direct to the consumers in the neighborhood.

A transformer in its simplest form consists of two independent coils of wire wound upon an iron ring. When an alternating current is passed through one of the coils, known as the primary, it produces a magnetic field which induces a current of electricity in the other, or secondary, coil.

The potential or voltage of the current in the secondary is in nearly the same ratio to the potential of the current passed into the primary as the number of turns in the secondary is to the number of turns in the primary.

Knowing this, it is very easy to arrange a transformer to "step" the potential up or down as desired. The transformer in Figure 178 represents a "step-up" transformer having ten turns of wire on the primary and twenty turns on the secondary. If an alternating current of 10 volts and 2 amperes is passed into the primary, the secondary winding will double the potential, since it has twice as many turns as the primary and the current delivered by the secondary will be

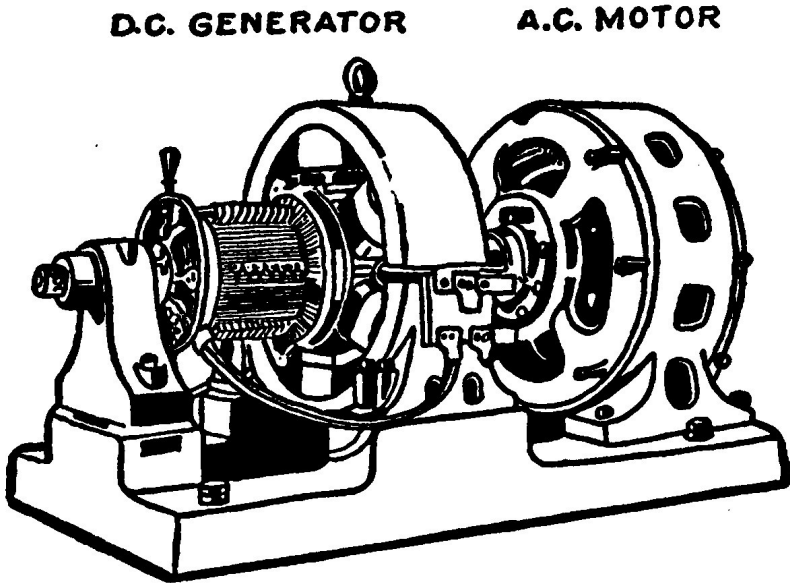

Fig. 177.—Motor Generator Set for changing Alternating Current to Direct Current.

approximately 20 volts and 1 ampere.

The action may be very easily reversed and a "step-down" transformer arranged by placing twenty turns of wire on the primary and ten turns on the secondary. If a current of 20 volts and 1 ampere is passed into the primary, the secondary will deliver a current of only 10 volts and 2 amperes, since it contains only half as many turns.

A circular ring of iron wire wound with two coils would in many respects be somewhat difficult to construct, and so the iron core is usually built in the form of a hollow rectangle and formed of sheets of iron.

It is often desirable to have at hand an alternating current of low voltage for experimental purposes. Such a current may be used for operating induction coils, motors, lamps, toy railways, etc., and is quite as satisfactory as direct current for many purposes, with the possible exception of electro-plating and storage-battery charging, for which it cannot be used.

When the supply is drawn from the 110-volt lighting circuit and passed through a small "step-down" transformer, the alternating current is not only

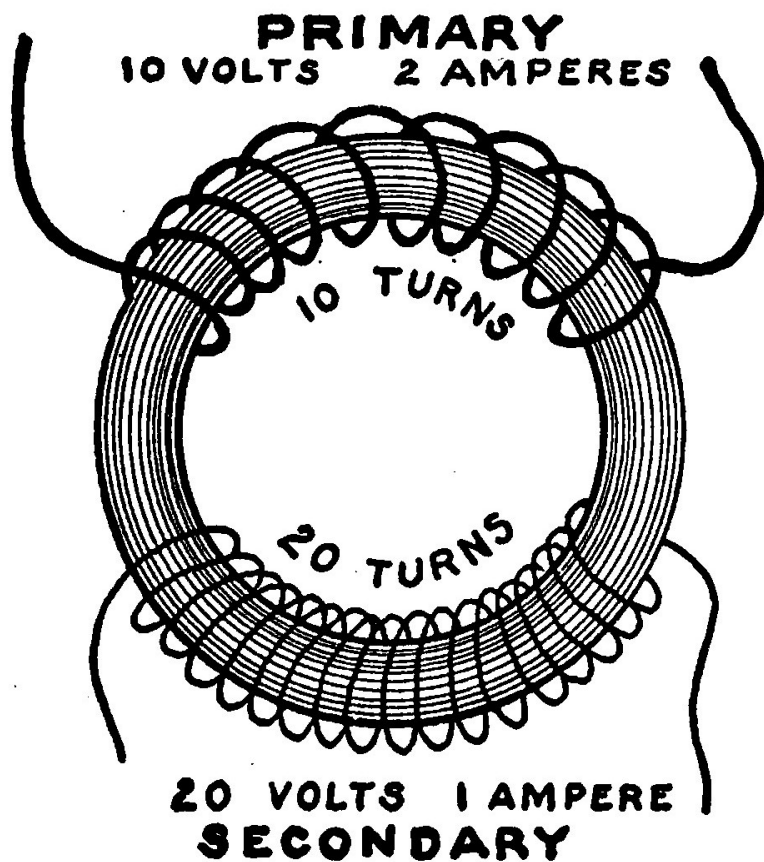

Fig. 178.—Step-Up Transformer.

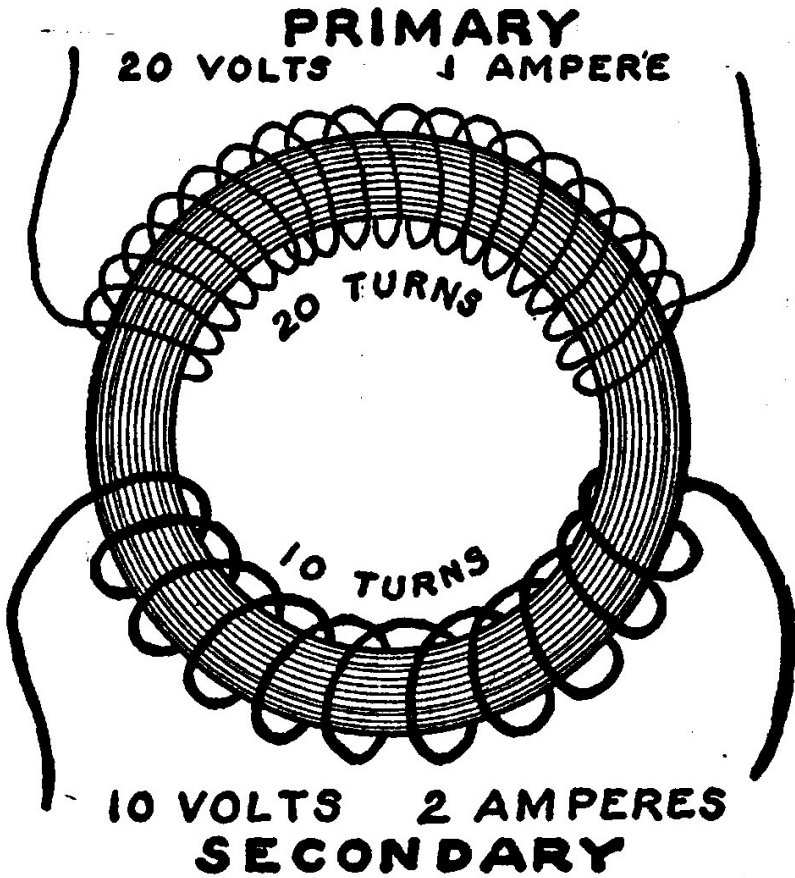

Fig. 179.—Step-Down Transformer.

cheaper but more convenient. A transformer of about 100 watts capacity, capable of delivering a current of 10 volts and 10 amperes from the secondary will not draw more than approximately one ampere from the 110-volt circuit. This current is only equal to that consumed by two ordinary 16-candle-power lamps or one of 32 candle-power, making it possible to operate the transformer to its full capacity for about one cent an hour. A further advantage is the fact that a "step-down" transformer enables the small boy to use the lighting current for operating electrical toys without danger of receiving a shock.

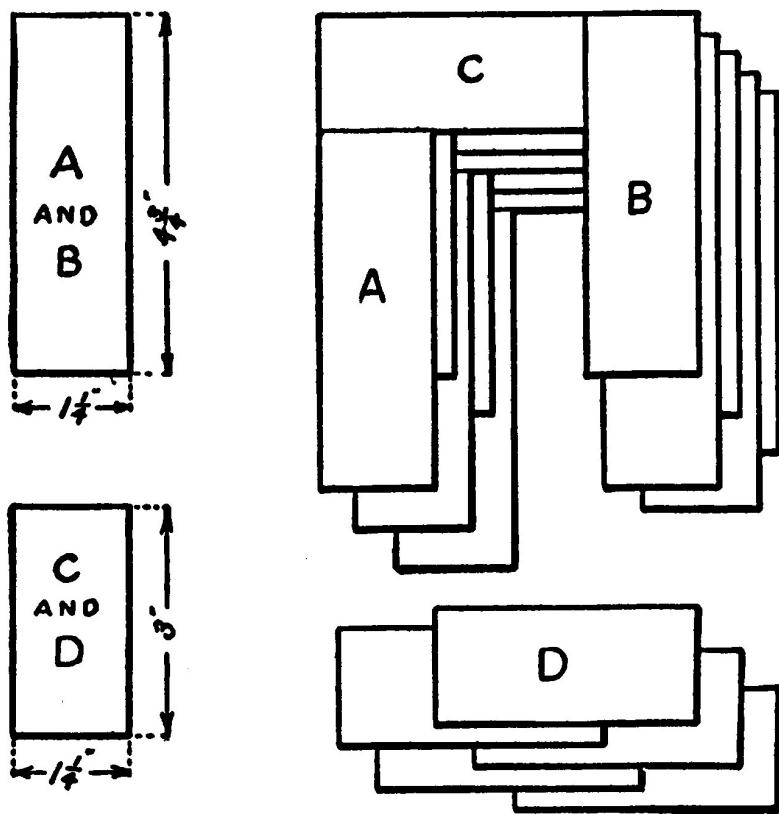

Fig. 180.—Core Dimensions.

The transformer described in the following pages can be easily built by any

boy at all familiar with tools, and should make a valuable addition to his electrical equipment, provided that the directions are carefully followed and pains are taken to make the insulation perfect.

The capacity of the transformer is approximately 100 watts. The dimensions and details of construction described and illustrated are those of a transformer intended for use upon a lighting current of 110 volts and 60-cycles frequency. The frequency of most alternating current systems is 25, 60, or 120 cycles. The most common frequency is 60. Dimensions and particulars of transformers for 25 and 120 cycles will be found in the form of a table farther on.

The frequency of your light circuit may be ascertained by inquiring of the company supplying the power.

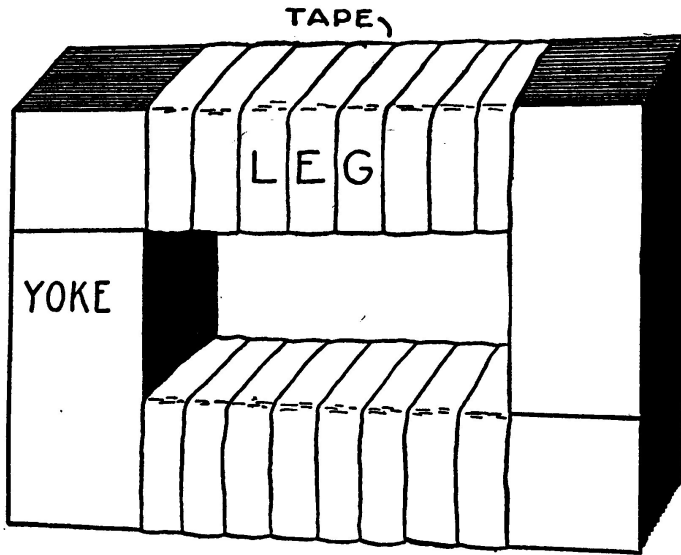

Fig. 181.—The Core, Assembled and Taped.

The first part to be considered in the construction of a transformer is the core. The core is made up of thin sheet-iron strips of the dimensions shown in Figure 180. The iron may be secured from almost any hardware store or plumbing shop by ordering "stove-pipe iron." Have the iron cut into strips 1 1/4 inches wide and 24 inches long. Then, using a pair of tinner's shears, cut the long strips into pieces 3 inches and 4 3/4 inches long until you have enough to make a pile of each 2 1/2 inches high when they are stacked up neatly and compressed. The

long strips are used to form the "legs" of the core, and the short ones the "yokes."

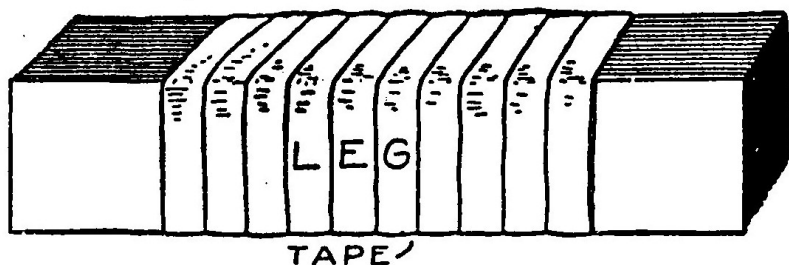

Fig. 182.—Transformer Leg.

The strips are assembled according to the diagram shown in Figure 180. The alternate ends overlap and form a hollow rectangle $4\frac{1}{4} \times 6$ inches. The core should be pressed tightly together and the legs bound with three or four layers of insulating tape preparatory to winding on the primary. After the legs are bound, the yoke pieces may be pulled out, leaving the legs intact.

Four fiber heads, $2\frac{1}{2}$ inches square and $\frac{1}{8}$ of an inch thick, are made as shown in Figure 183. A square hole $1\frac{1}{4} \times 1\frac{1}{4}$ inches is cut in the center. Two of these are placed on each of the assembled legs as shown in Figure 184.

The primary winding consists of one thousand turns of No. 20 B. & S. gauge single-cotton-covered magnet wire. Five hundred turns are wound on each leg of the transformer. The wire should be wound on very smoothly and evenly with a layer of shellacked paper between each layer of wire.

The two legs should be connected in series. The terminals are protected and insulated by covering with some insulating tape rolled up in the form of a tube.

The secondary winding consists of one hundred turns of No. 10 B. & S. gauge double-cotton-covered wire. Fifty turns are wound on each leg, over the primary, several layers of paper being placed between the two.

A "tap" is brought out at every ten turns. The taps are made by soldering a narrow strip of sheet-copper to the wire at proper intervals. Care must be taken to insulate each joint and tap with a small strip of insulating tape so that there is no danger of a short circuit being formed between adjacent turns.

After the winding is completed the transformer is ready for assembling. The yoke pieces of the core should be slipped into position and the whole carefully lined up. The transformer itself is now ready for mounting.

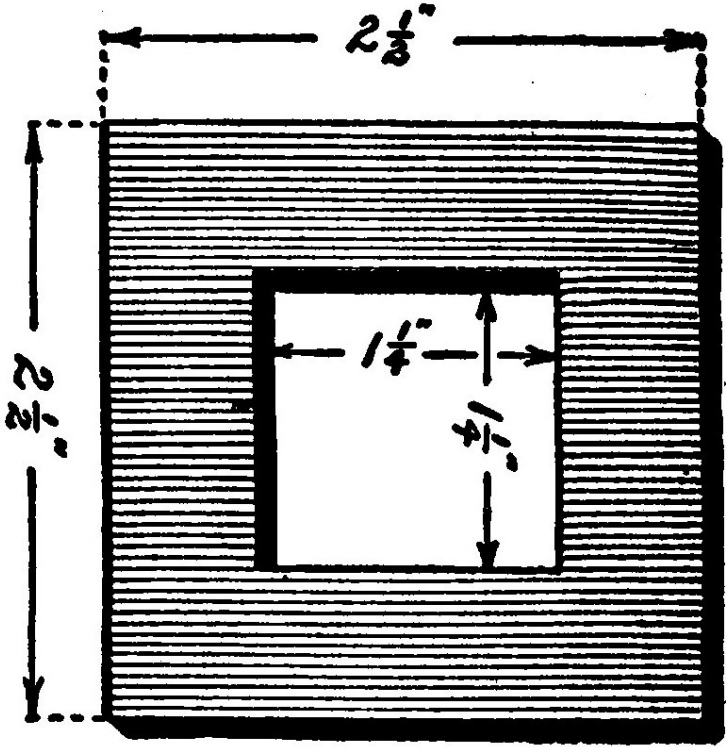

Fig. 183.—Fiber Head.

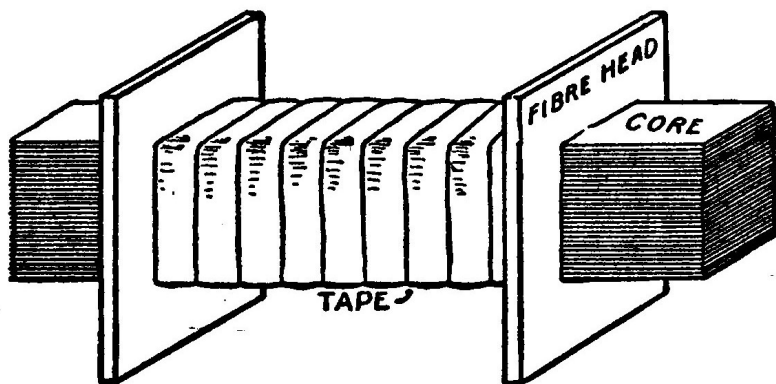

Fig. 184.—Leg with Heads in Position for Winding.

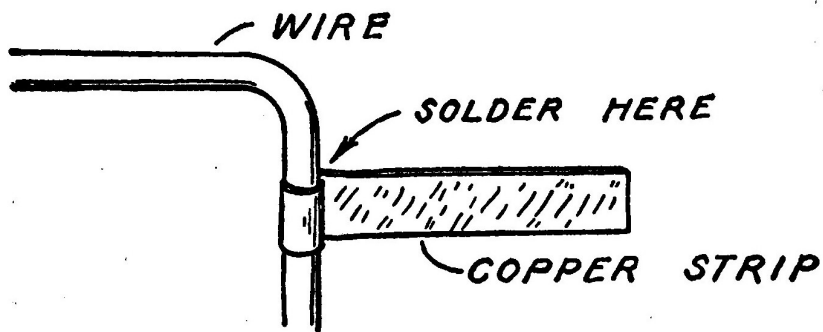

Fig. 185.—How to make a Tap in the Primary by soldering a Copper Strip to the Wire.

The base-board measures $11 \times 7 \frac{3}{4} \times 7 \frac{7}{8}$ inches. It is shown in Figure 192.

The transformer rests upon two wooden strips, *A* and *B*, $4 \frac{1}{4}$ inches long, $1 \frac{1}{4}$ inches wide, and $\frac{3}{4}$ of an inch high. The strips are nailed to the base so that they will come under the ends of the core outside of the fiber heads.

The transformer is held to the base by two tie-rods passing through a strip, *C*, 6 inches long, one-half of an inch thick and three-quarters of an inch wide. The strip rests on the ends of the core. The tie-rods are fastened on the under side of the base by means of a nut and washer on the ends. When the nuts are screwed up tightly, the cross-piece will pull the transformer firmly down to the base.

The regulating switches, two in number, are mounted on the lower part of the base. The contact points and the arm are cut out of sheet-brass, one-eighth of an inch thick. It is unnecessary to go into the details of their construction, because the dimensions are plainly shown in Figure 188.

The contacts are drilled out and countersunk so that they may be fastened to the base with small flat-headed wood screws.

Each switch-arm is fitted with a small rubber knob to serve as a handle. The arm works on a small piece of brass of exactly the same thickness as the switch-points. Care must be taken that the points and this washer are all exactly in line, so that the arm will make good contact with each point. There are five points to each switch, as shown in Figure 190.

The switch, *D*, is arranged so that each step cuts in or out twenty turns of the secondary, the first point being connected with the end of the winding. The second point connects with the first tap, the third contact with the second tap, the fourth contact with the third tap, and the fifth contact with the fourth tap.

The switch, *E*, is arranged so that each step cuts in or out five turns. The contacts on this switch are numbered in the reverse direction. The fifth contact of switch *D*, and the fifth contact of switch *E*, are connected together. The fourth contact is connected to the fifth tap, the third contact to the sixth tap, the second contact to the seventh, and the first contact to the end of the winding.

This arrangement makes it possible to secure any voltage from one-half to ten in one-half-volt steps from the secondary of the machine. Each step on the switch, *D*, will give two volts, while those on *E* will each give one-half of a volt.

Two binding-posts (marked *P* and *P* in the drawing) mounted in the upper corners of the base are connected to the terminals of the primary winding. The two posts in the lower corners (marked *S* and *S* in the drawing) are connected to the switch levers, and are the posts from which the secondary or low voltage is obtained.

The transformer may be connected to the 110-V. alternating current circuit by means of an attachment plug and cord. One end of the cord is placed in each of

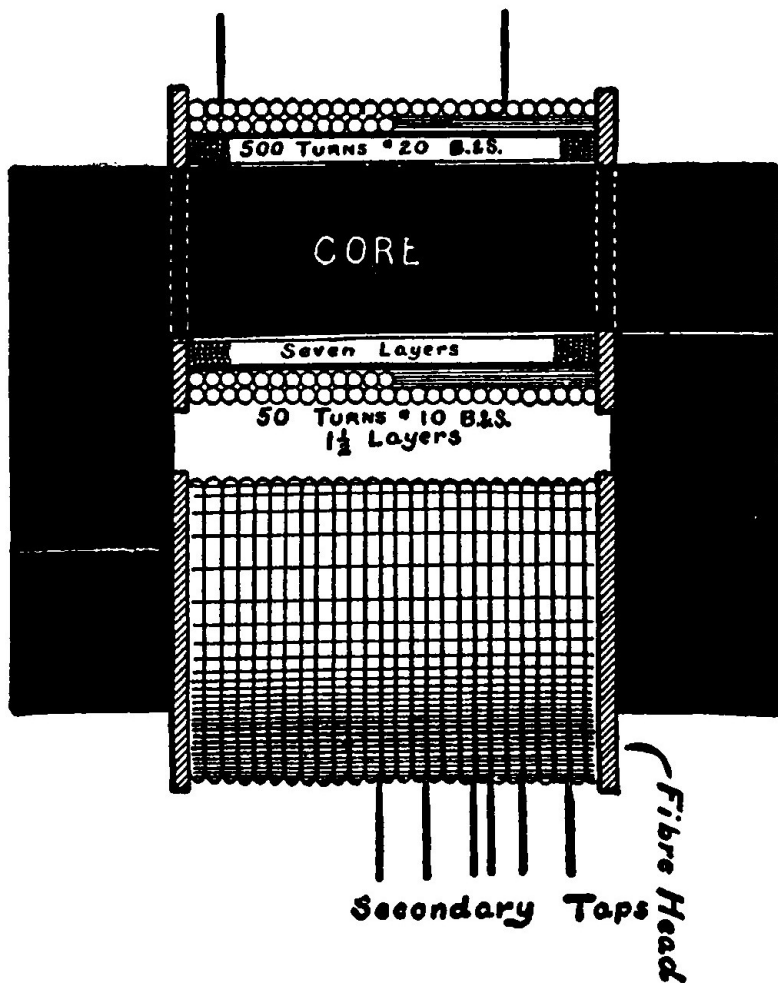

Fig. 186.—The Transformer completely Wound and ready for Assembling.

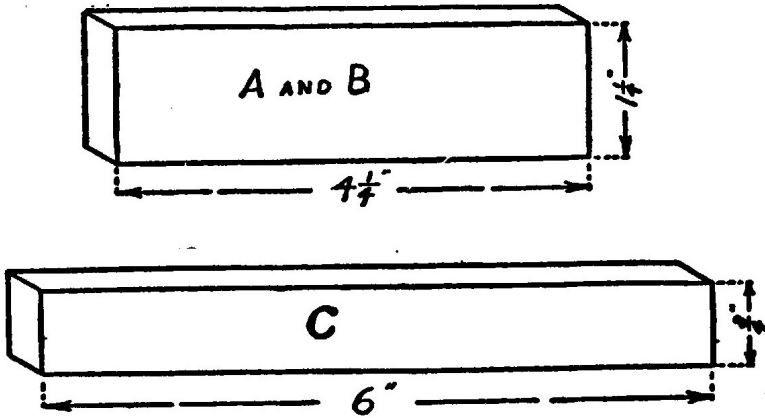

Fig. 187.—Wooden Strips for mounting the Transformer on the Base.

the primary binding-posts. The other end of the cord is connected to the attachment plug so that the latter may be screwed into any convenient electric-light socket.

The transformer must not be connected directly to the line. An instrument such as this is not designed for continuous service and is intended to be disconnected as soon as you are through using it.

It will be found a great convenience in operating many of the electrical devices described, wherever direct current is not essential.

CHAPTER VIV WIRELESS TELEGRAPHY

Probably no branch of electrical science ever appealed more to the imagination of the experimenter than that coming under the heading of wireless telegraphy. Wherever you go, you are likely to see the ear-marks of *amateur* wireless telegraph stations in the aerials and masts set up in trees and on house-tops. It is estimated that there are nearly a quarter of a million such stations in the United States.

There is really no great mystery about this wonderful art which made possible the instantaneous transmission of messages over immense distances without any apparent physical connection save that of the earth, air, or water.

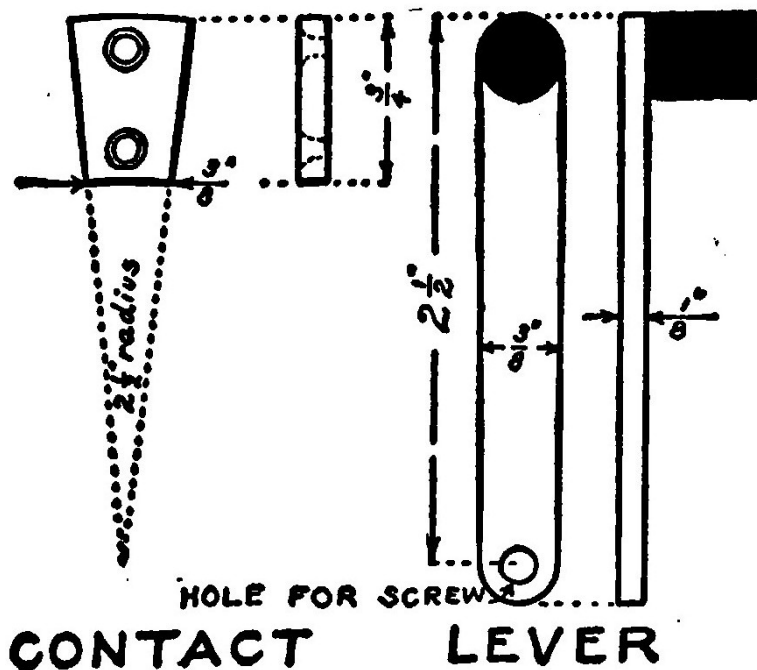

Fig. 188.—Details of the Switch Parts.

Did you ever throw a stone in a pool of water? As soon as the stone struck, little waves spread out from the spot in gradually enlarging circles until they reached the shore or died away.

By throwing several stones in succession, with varying intervals of time between them, it would be possible so to arrange a set of signals, that they would convey a meaning to a second person standing on the opposite shore of the pool.

Wireless telegraphy is based upon the principle of *creating and detecting* waves in a great *pool* of ether.

Modern scientists suppose that all space is filled with an "imaginary" substance called *ether*. The ether is invisible, odorless, and practically weightless. This ether, however, bears no relation to the anaesthetic of that name which is used in surgical operations.

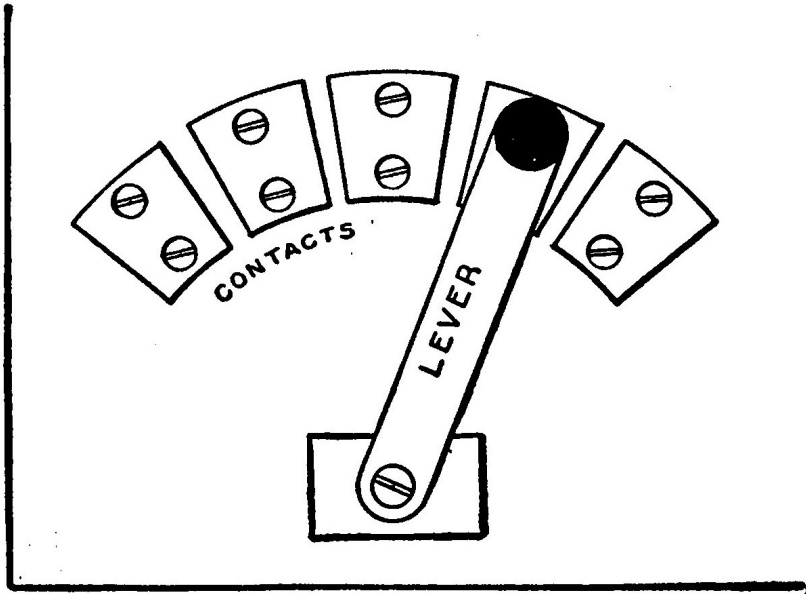

Fig. 189.—The Complete Switch.

It surrounds and penetrates all substances and all space.

It exists in a vacuum and in solid rocks. Since the ether does not make itself apparent to any of our physical senses, some of these statements may seem contradictory. Its definite existence cannot be proved except by reasoning, but by accepting and imagining its reality, it is possible to understand and explain many scientific puzzles.

A good instance is offered by the sun. Light and heat can be shown to consist of extremely rapid vibrations. That fact can be proved. The sun is over 90,000,000 miles away from our earth and yet light and heat come streaming down to us through a space that is devoid even of air. Something must exist as a medium to transmit these vibrations; it is the ether.

Let us consider again the pool of water. The waves or ripples caused by throwing in the stone are vibrations of the water. The distance between two adjacent ripples is called the *wave length*.

The distances between two vibrations of light can also be *measured*. They are so small, however, that they may be spoken of only in *thousandths* of an inch.

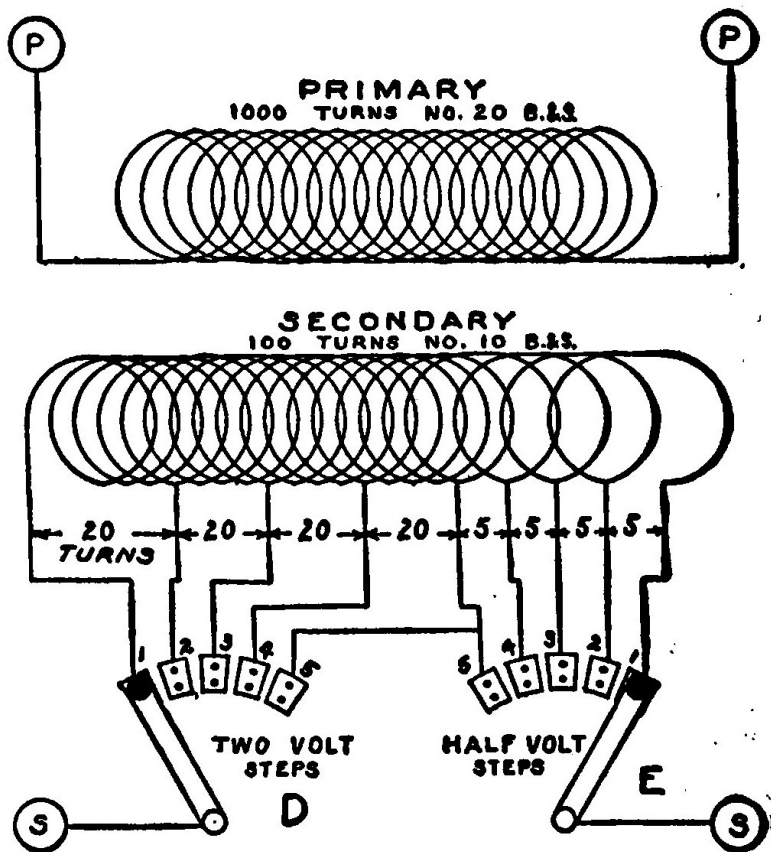

Fig. 190.—Diagram of Connections.

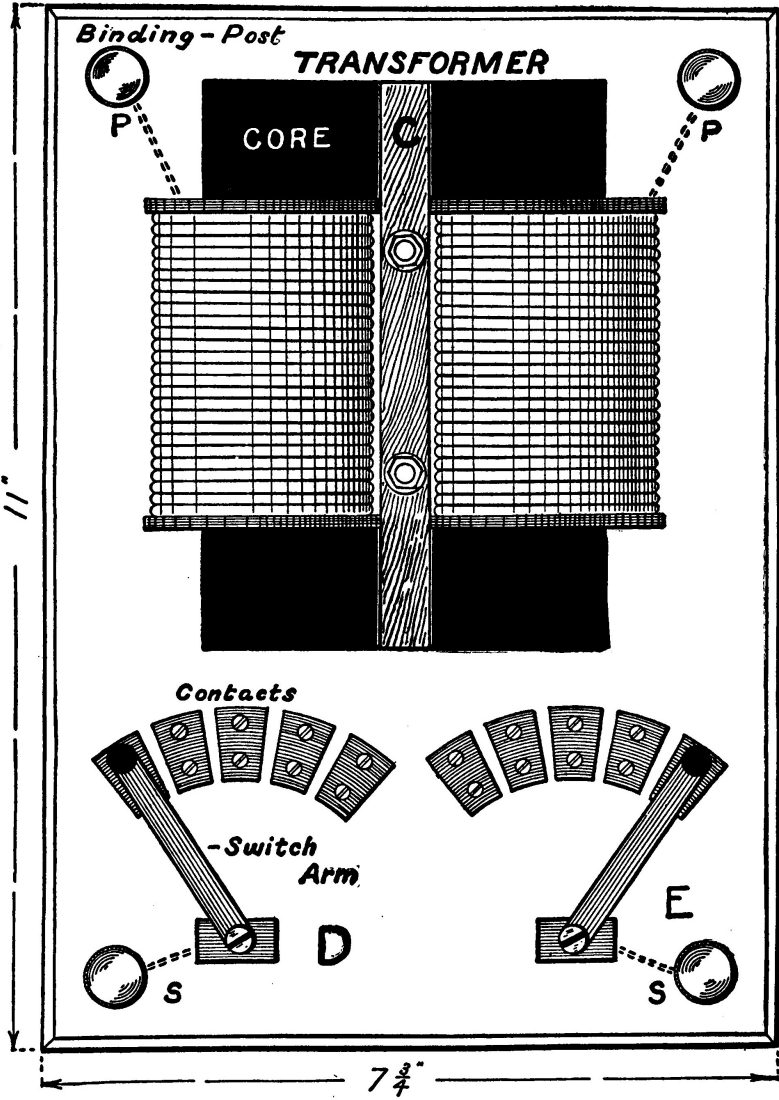

Fig. 191.—Top View of the Transformer.

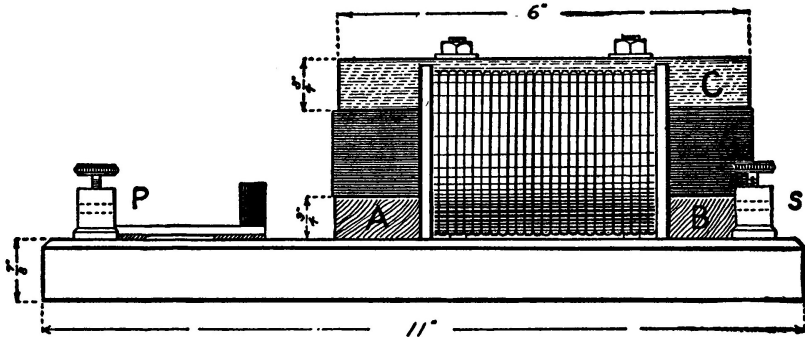
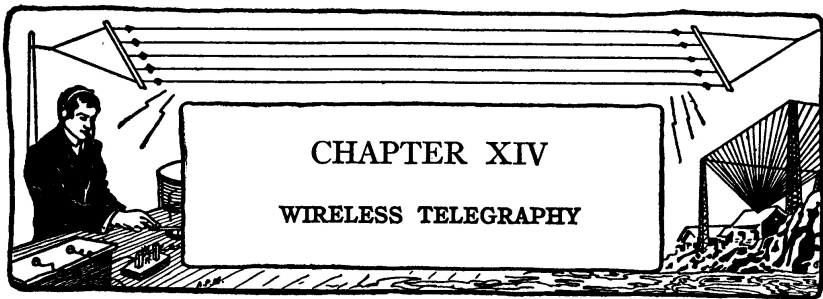

Fig. 192.—Side View of the Transformer.



The waves created in the ether by wireless telegraph apparatus are the same as those of light except that their length usually varies from 75 to 9,000 *feet* instead of a fraction of a thousandth of an inch.

A **Simple Transmitter** is illustrated in Figure 194. A telegraph key is connected in series with a set of cells and the *primary* of an induction coil, which, it will be remembered, is simply a coil consisting of a few turns of wire. This induces a high voltage in a second coil consisting of a larger number of turns and called the *secondary*.

The terminals of the secondary are led to a spark-gap—an arrangement composed of two polished brass balls, separated by a small air-gap. One of the balls, in turn, is connected to a metal plate buried in the earth, and the other to a network of wires suspended high in the air and insulated from all surrounding objects.

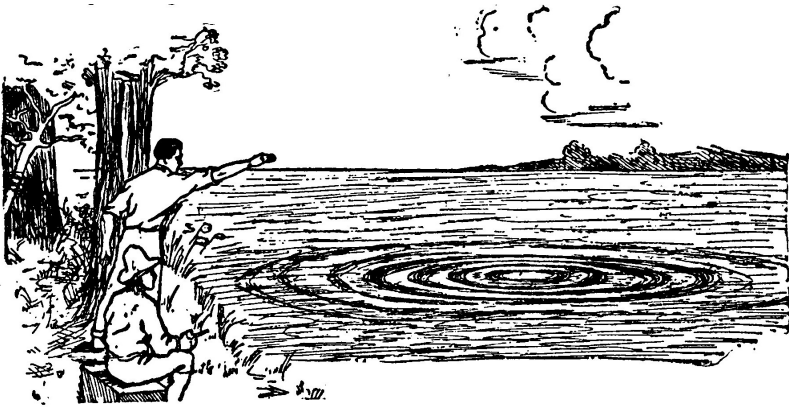

Fig. 193.—Little Waves spread out from the Spot.

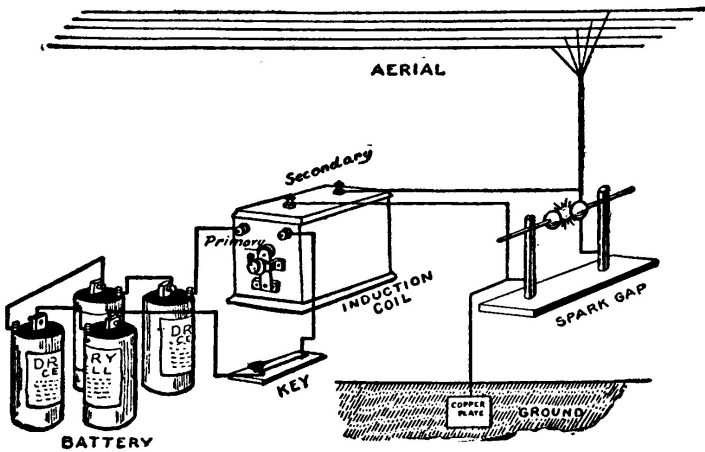

Fig. 194.—A Simple Transmitter.

When the key at the transmitter is pressed, the battery current flows through the primary of the induction coil and generates in the secondary a current of very high voltage, 20,000 volts or more, which is able to jump an air-gap in the shape of a spark at the secondary terminals. The latter are connected to the earth and aerial, as explained above. The high potential currents are therefore enabled to charge the aerial. The charge in the aerial exerts a great tendency to pass into the ground, but is prevented from doing so by the small air-gap between the spark-balls until the charge becomes so great that the air-gap is punctured and the charge passes across and flows down into the ground. The passage of the charge is made evident by the spark between the two spark-balls.

The electrical charges flowing up and down the aerial disturb the ether, strike it a blow, as it were. The effect of the blow is to cause the ether to vibrate and to send out waves in all directions. It may be likened to the pond of water which is suddenly struck a blow by throwing a stone into it, so that ripples are immediately sent out in widening circles.

These Waves in the Ether are called electro-magnetic or *Hertzian* waves, after their discoverer, Hertz. The distance over which they pass is dependent upon the power of the transmitting station. The waves can be made to correspond to the dots and dashes of the telegraphic code by so pressing the key. If some means of detecting the waves is employed we may readily see how it is possible to send wireless messages.

The Action of the Receiving Station is just the opposite of that of the transmitter. When the waves pass out through the ether, some of them strike the aerial of the receiving station and generate a charge of electricity in it which tends to pass down into the earth. If the transmitting and receiving stations are very close together and the former is very powerful, it is possible to make a very small gap in the receiving aerial across which the charge will jump in the shape of sparks. Thus the action of the receptor simply takes place in a reversed order from that of the transmitter.

If the stations are any considerable distance apart, it is impossible for the currents induced in the receiving aerial to produce sparks, and so some more sensitive means of detecting the waves from the transmitter is necessary, preferably one which makes itself evident to the sense of hearing.

The telephone receiver is an extremely sensitive instrument, and it only requires a very weak current to operate it and produce a sound. The currents or *oscillations* generated in the aerial, however, are alternating currents (see pages 97-99) of *high frequency*, that is, they flow in one direction and then reverse and flow in the other several thousand times a second. Such a current cannot be made to pass through a telephone receiver, and in order to do so the nature of the current must be changed by converting it into direct current flowing in one

direction only.

Certain minerals and crystals possess the remarkable ability to do this, *silicon*, galena, and iron pyrites are among the best.

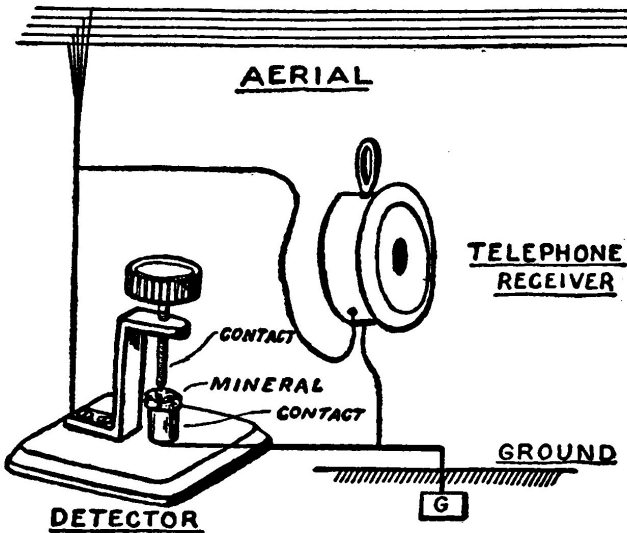

Fig. 195.—A Simple Receptor.

The diagram in Figure 195 shows the arrangement of a simple receiving outfit. The *detector* consists of a sensitive mineral placed between two contacts and connected so that the aerial currents must pass through it on their way to the ground. A telephone receiver is connected to the detector so that the *rectified currents* (currents which have been changed into direct current) pass into it and produce a sound. By varying the periods during which the key is pressed at the transmitting station, according to a prearranged code, the sounds in the receiver may be made to assume an intelligible meaning.

HOW TO BUILD WIRELESS INSTRUMENTS

The Aerial

Every wireless station is provided with a system of wires elevated high in the air, above all surrounding objects, the purpose of which is to radiate or intercept the electromagnetic waves, accordingly as the station is transmitting

or receiving. This system of wires is, as already has been stated, called the *aerial* or *antenna*.

The arrangement of the aerial will greatly determine the efficiency and range of the apparatus.

The aerial should be as long as it is reasonably possible to make it, that is from 50 to 150 feet.

It will be necessary for most amateurs to put up their aerial in some one certain place, regardless of what else may be in the vicinity, but whenever possible the site selected should preferably be such that the aerial will not be in the immediate neighborhood of any tall objects, such as trees, smoke-stacks, telephone wires, etc., because such objects will interfere with the aerial and noticeably decrease the range of the station, both when transmitting and receiving.

Bare copper wire makes the best aeriels. Aluminum wire is very often used and on account of its light weight causes very little strain on the poles or cross arms. Iron wire should never be used for an aerial, even if galvanized or tinned, because it tends to choke the currents which must flow up and down the aerial when the station is in operation.

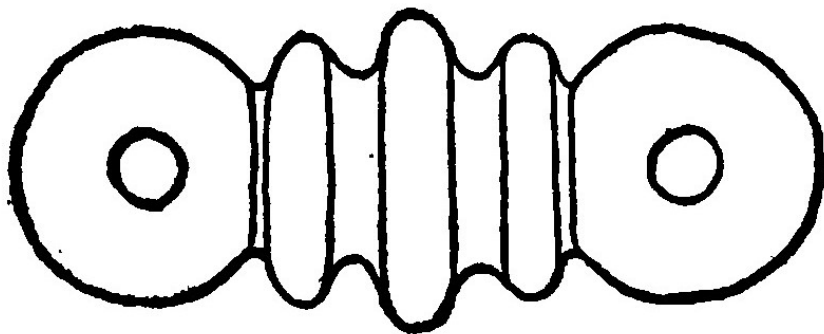

Fig. 196.—Molded Aerial Insulator

The aerial must be very carefully insulated from its supports and all surrounding objects. The insulation must be strong enough to hold the weight of the aerial and able to withstand any strain caused by storms.

Special aerial insulators made of molded insulating material and having an iron ring imbedded in each end are the best.

Ordinary porcelain cleats may be used on small aeriels where the strain is light.

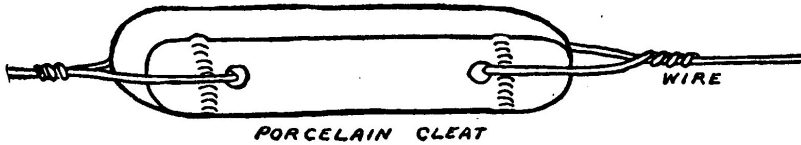

Fig. 197.—A Porcelain Cleat will make a Good Insulator for Small Aerials.

One insulator should be placed at each end of each wire close to the spreader or spar.

Most aerials are made up of four wires. The wires should be placed as far apart as possible.

There are several different forms of aerials, the principal ones of which are shown in Figure 199. They are known as the grid, "V," inverted "L," and "T" types.

Most amateurs support their aerials from a pole placed on the top of the house, in a tree, or erected in the yard. Many use two supports, since such an aerial has many advantages. The facilities to be had for supporting the aerial will largely determine which form to use.

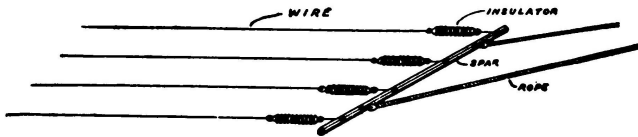

Fig. 198.—Method of Arranging the Wires and Insulating them from the Cross Arm or Spreader.

The grid aerial has no particular advantages or disadvantages.

The "V" aerial receives waves much better when they come from a direction opposite to that in which the free end points. The "free" end of the aerial is the one not leading into the station.

The inverted "L" aerial possesses the same characteristics as the "V" type.

The "T" aerial is the best "all around" and is to be recommended whenever it is possible to put up an aerial of this sort.

Much of the detail of actually putting up an aerial or antenna must be omitted, because each experimenter will usually meet different conditions.

It should be remembered, however, that the success of the whole undertak-

ing will rest largely upon the construction of a proper aerial. The most excellent instruments will not give very good results if connected to a poor aerial, while, on the other hand, inferior instruments will often give fair results when connected to a good aerial.

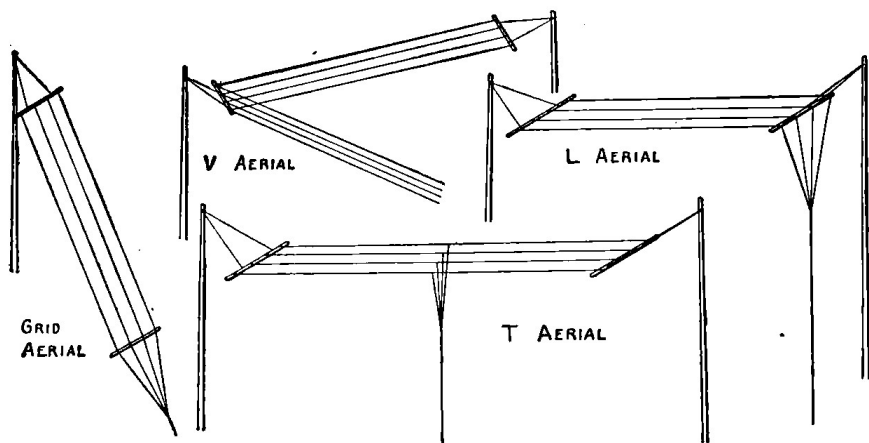

Fig. 199.—Various Types of Aerials.

The aerial should be at least thirty feet high.

The wire should not be smaller than No. 14 B. & S.

The masts which support the aerial should be of wood and provided with pulleys so that the wires may be lowered any time it may be necessary. The mast should be thoroughly braced with stays or guys so as to counteract the strain of the aerial.

The aerial should not be hoisted up perfectly tight, but should be allowed to hang somewhat loose, as it will then put less strain on the ropes and poles that support it.

When an aerial is to be fastened in a tree, it is best to attach it to a pole placed in the top of the tree, so that it will come well above any possible interference from the branches.

The wires leading from the aerial to the instruments should be very carefully insulated throughout their length. This part of the aerial is called the "rat-tail" or lead-in.

The illustrations in Figure 199 show the proper place to attach the "lead-in" form of aerial. The wires should gradually converge.

It is very important that a good ground connection be secured for wireless

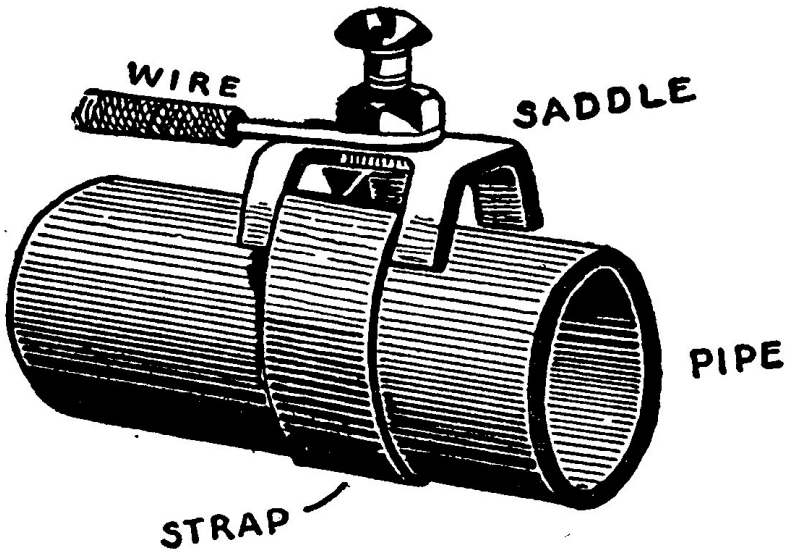

Fig. 200.—A Ground Clamp for Pipes.

instruments. A good ground is absolutely necessary for the proper working of the apparatus. Amateur experimenters usually use the water or gas-pipes for a ground, and fasten the wires by means of a ground clamp such as shown in Figure 200. In the country, where such pipes are not available, it is necessary to bury a sheet of copper, three or four feet square, in a moist spot in the earth and connect a wire to it.

The Receiving Apparatus

The receiving instruments form the most interesting part of a wireless station and usually receive first attention from the amateurs. They are the ears of the wireless station and are wondrously sensitive, yet are very simple and easy of construction.

The instruments necessary for receiving are:

A Detector,

A Tuning Coil or a Loose Coupler,

A Fixed Condenser,

A Telephone Receiver.

Other devices, such as a test buzzer, variable condenser, etc., may be added and will improve the outfit.

After the aerial has been properly erected, the first instrument necessary to construct will be either a tuning coil or a loose coupler. It is a good plan to make a tuning coil first, and a loose coupler after you have had a little experience with your apparatus.

A **Tuning Coil** is a very simple arrangement making it possible to receive messages from greater distances, and also somewhat to eliminate any messages not desirable and to listen without confusion to the one wanted.

A tuning coil consists of a single layer of wire wound upon a cylinder and arranged so that connection may be had with any part of it by means of sliding contacts.

The cylinder upon which the wire is wound is a cardboard tube six and three-quarters inches long and two and seven-eighths inches in diameter outside. It should be given two or three coats of shellac both inside and out so that it is thoroughly impregnated, and then laid away until dry. This treatment will prevent the wire from becoming loose after the tube is wound, due to shrinkage of the cardboard.

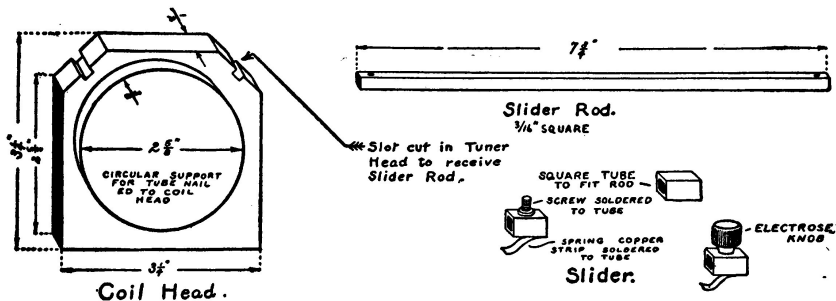

Fig. 201.—Details of the Tuning Coil.

After having become dry, the tube is wound with a single layer of No. 25 B. & S. gauge green silk or cotton-covered magnet wire. The wire must be wound on very smoothly and tightly, stopping and starting one-quarter of an inch back

from each end. The ends of the wire are fastened by weaving back and forth through two small holes punched in the cardboard tube with a pin.

The winding should be given a single coat of clear varnish or white shellac and allowed to dry.

The coil heads or end pieces are cut from one-half-inch wood according to the plan and dimensions shown in the accompanying illustration.

The top corners are beveled and notched to receive the slider-rods. A circular piece of wood two and five-eighths inches in diameter and three-eighths of an inch thick is nailed to the inside of each of the coil heads to support the ends of the cylinder.

The wooden parts should be stained mahogany or some other dark color and finished with a coat of shellac or varnish.

The slider-rods are square brass 3-16 x 3-16 inches and seven and three-quarters inches long. A small hole is bored near the ends of each, one-quarter of an inch from the edge, to receive a round-headed brass wood screw which holds the rod to the tuner end.

The sliders may be made according to the plan shown in Figure 201.

The slider is made from a small piece of brass tubing, three-sixteenths of an inch square. An 8-32 flat-headed brass screw is soldered to one face, in the center. A small strip of phosphor bronze sheet or spring copper soldered to the bottom of the slider forms a contact for making connection to the wire on the cylinder. A small "electrose" knob screwed to the slider makes a neat and efficient handle.

Two sliders are required, one for each rod.

The tuning coil is assembled as shown in Figure 203. The cardboard tube is held in place by several small brass nails driven through it into the circular pieces on the coil heads.

A slider is placed on each of the slider-rods and the rods fastened in the slots in the coil ends by a small round-headed brass screw, passing through the holes bored near the ends for that purpose.

Two binding-posts are mounted on one of the coil ends. One should be connected to each of the slider-rods. A third binding-post is placed below in the center of the head and connected to one end of the wire wound around the cylinder.

A small, narrow path along the coil, directly underneath each slider and to which the copper strip can make contact, must be formed by scraping the insulation off the wire with a sharp knife. The sliders should make contact with each one of the wires as they pass over, and should slide smoothly without damaging or disarranging any of the wires.

When scraping the insulation, be very careful not to loosen the wires or remove the insulation from between them, so that they are liable to short-circuit

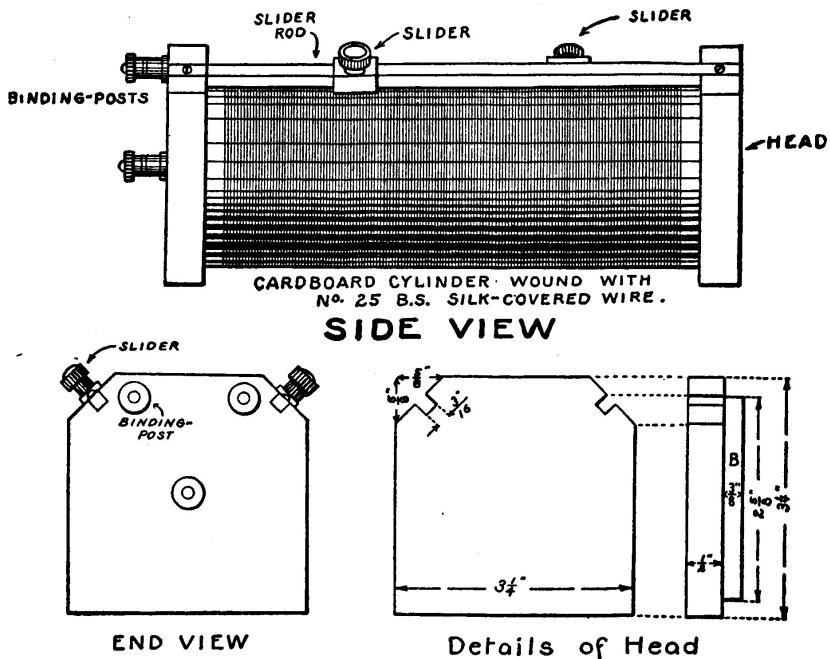

Fig. 202.—Side and End Views of the Tuning Coil.

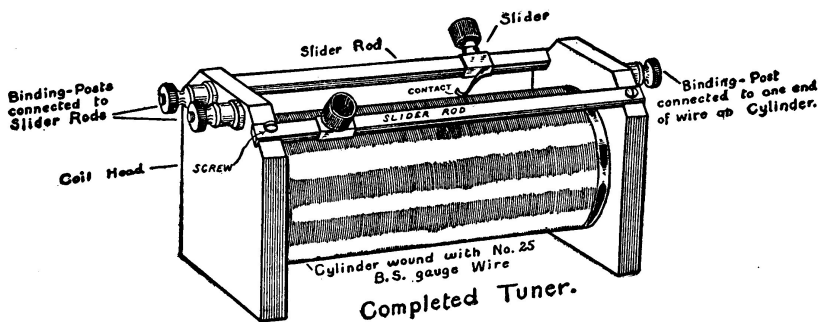

Fig. 203.—Complete Double-Slider Tuning Coil.

between adjacent turns.

A Loose Coupler is a much more efficient tuning device than a double-slider tuner, and sooner or later most amateur wireless operators install one in their station.

The loose coupler shown in the figure given on the next page is a very simple one and is both easy and inexpensive to build. Its simplicity is a disadvantage in one respect, however. Owing to its construction, it is impossible to move the slider on the secondary when the latter is inside the primary. The reason that I have chosen this sort of loose coupler to describe is to acquaint my young readers with the methods of making a loose coupler.

The "Junior" loose coupler described farther on is a more elaborate instrument of greater efficiency, but much harder to build.

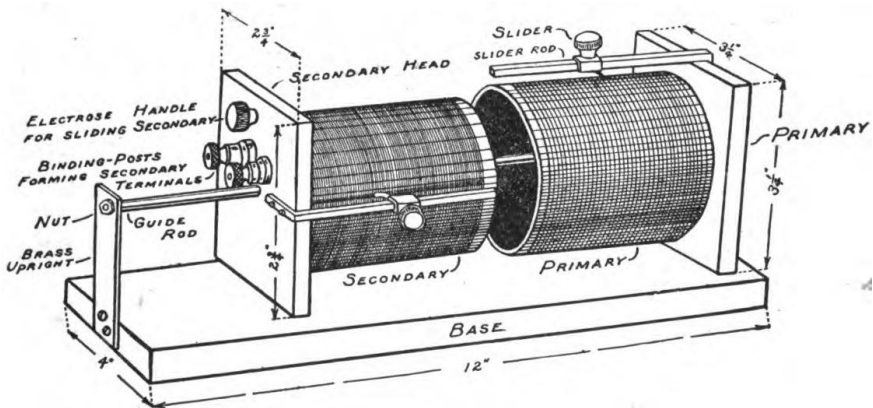

Fig. 204.—A Simple Loose Coupler.

The base of the loose coupler is of wood and measures twelve by four inches. The head supporting the primary is of the same size as those used on the "Junior" double-slide tuning coil just described. It may be made in the same manner, and fitted with a circular block to support the tube. The primary tube is of the same diameter as that on the tuning coil but is only four inches long. It is fastened to the primary head with glue and then secured with a number of small tacks. One or two coats of shellac liberally applied will render it non-shrinkable, so that the wire will not be apt to loosen after the loose coupler has been in use a while.

The secondary is of the same length as the primary, but of smaller diameter, so that it will easily slip inside. It also is treated with shellac.

The primary should be wound with a single layer of No. 22 single-silk-covered magnet wire. The secondary is wound with No. 29 single-silk.

The head supporting the secondary is smaller than that used for the same purpose on the primary. The round boss to which the tube is fastened, however, is much thicker.

The secondary slides on a "guide-rod" supported at one end by passing through the primary head and at the other by a brass upright. The upright may also be made of wood.

If the secondary is "offset," that is, placed out of center slightly to one side, it will leave room so that the secondary slider will possibly pass inside of the primary without striking.

Both the primary and the secondary must be fitted with "sliders" to make contact with the various turns of wire.

The method of constructing a slider has already been described.

The ends of the slider-rods are bent at right angles and fastened to the coil heads by two small screws passing through holes bored near the ends. A small narrow path must be scraped in the insulation under each so that the slider will make contact with each turn. The secondary head may be provided with a small electrose handle to facilitate sliding it back and forth.

Two binding-posts are mounted on each of the coil heads.

One post on each is connected to the end of the coil farthest from the head, and the other posts are each connected to the slider-rods.

Figure 220 shows how to connect the loose coupler in the receiving set.

In order to tune with a loose coupler, first adjust the slider on the primary until the signals are the clearest. Then set the secondary slider in the best place and move the secondary in and out of the primary until the signals are clearest.

How to Build the Junior Loose Coupler

A loose coupler of the sort just described is simple and quite easily constructed, but will not be found to work as well as one in which the secondary may be varied by means of a switch while it is inside of the primary.

The base of the instrument measures twelve by three and five-eighths inches. The primary is composed of a single layer of No. 24 B. & S. gauge single-silk-covered wire wound on a cardboard tube two and three-quarter inches in diameter and three and three-quarter inches long. The winding is laid on in a single layer and should comprise about 150 turns. After winding on tightly, it should be given a coat of clean white shellac and allowed to dry. The shellac is for the purpose of fastening the wire down tightly to the tube so that it will not loosen when the slider is moved back and forth.

The primary is mounted between two heads, the details of which are shown in Figure 205. One of the heads, *B*, has a flanged hole two and three-quarter inches

in diameter cut through the center so as to receive the end of the tube and permit the secondary to pass inside.

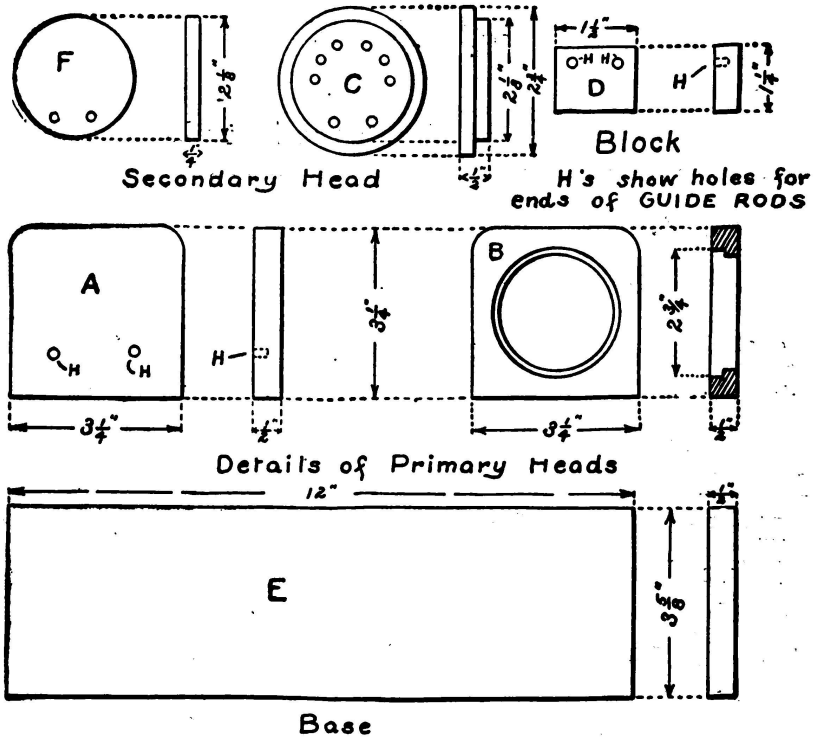

Fig. 205.—Details of the Wooden Parts.

The secondary winding is composed of a single layer of No. 28 B. & S. gauge silk-covered wire and divided into six equal sections. The secondary is supported by two circular wooden pieces, **C** and **F**, and slides back and forth on two guide-rods. The guide-rods should be brass. Iron or steel rods running through the center of a loose coupler will seriously weaken the signals, and such practice must by all means be avoided.

The secondary sections are connected to six contacts and a switch-arm mounted on the end of the secondary so that by turning the switch either one, two, three, four, five, or six sections of the winding may be connected.

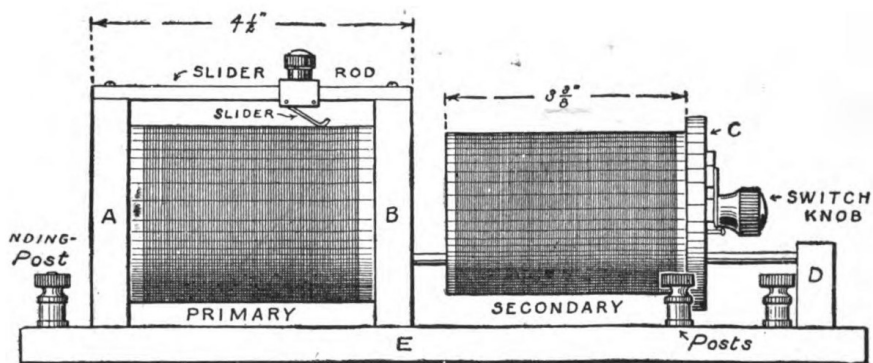

Fig. 206.—Side View of the Loose Coupler.

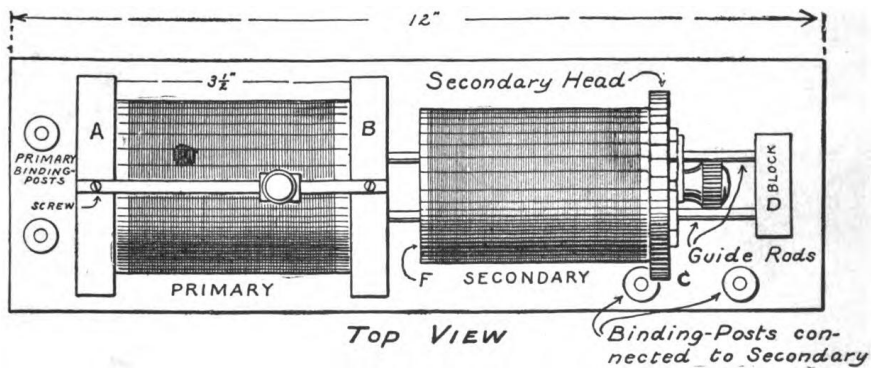

Fig. 207.—Top View of the Loose Coupler.

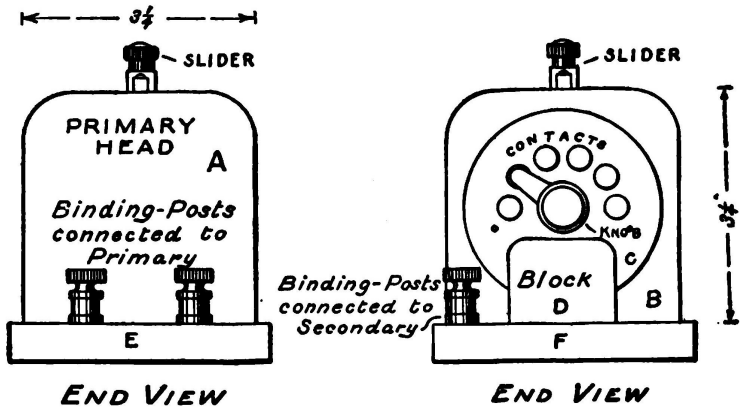

Fig. 208.—End Views of the Loose Coupler.

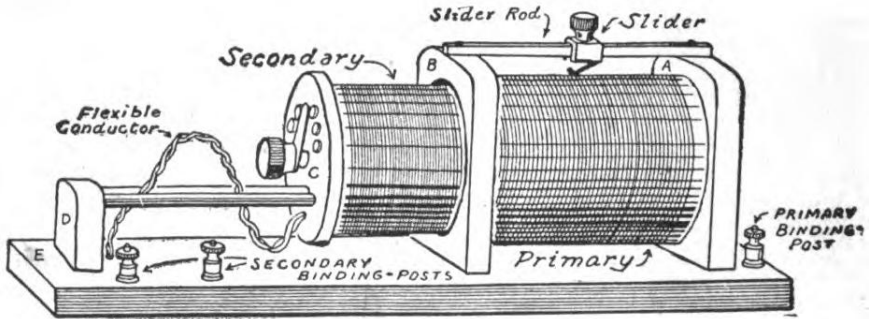

Fig. 209.—Complete Loose Coupler.

The two binding-posts near the secondary end of the coupler are connected to the terminals of the secondary winding by means of two flexible wires. They have not been shown in several of the illustrations because they would be liable to confuse the drawing.

The primary is provided with a slider moving back and forth over a narrow path scraped through the insulation so that it may make contact with each wire independently.

Detectors

Detectors are very simple devices and consist merely of an arrangement for holding a small piece of certain minerals and making a contact against the surface.

The crystal detector shown in Figure 210 is a very efficient form that may be easily and quickly made. When finished, it will make a valuable addition to almost any amateur experimenter's wireless equipment.

The bracket is bent out of a piece of strip brass about one-eighth of an inch thick and five-eighths of an inch wide, according to the shape shown in the illustration. The bracket is mounted on a circular wooden base about three inches in diameter. The circular wooden blocks used by electricians in putting up chandeliers, called "fixture blocks," will make a satisfactory base. An electrose knob of the typewriter type may be purchased from any good dealer in wireless supplies. It should be fitted with a threaded shank which will screw into a hole in the upper part of the bracket.

The mineral is contained in a small brass cup mounted on the base below the end of the knob.

Contact with the mineral in the cup is made by means of a fine wire spring soldered to the end of the adjusting screw.

Moving the screw up or down will vary the pressure of the spring on the mineral and permit the most sensitive adjustment to be secured. The bracket is connected to one of the binding-posts and the cup to the other.

The detector shown in Figure 212 is of the type often termed a "cat-whisker," because of the long, fine wire resting on the mineral.

It consists of a small clip, formed by bending a strip of sheet-brass, which grips a piece of galena.

Galena may be obtained from any dealer in radio supplies. A piece of No. 30 phosphor bronze wire is soldered to the end of a short length of brass rod supported by a binding post. The other end of the rod is fitted with an electrose knob. This part of the detector is called the "feeler."

The detector is fitted with binding posts and may be mounted upon any suitable small base. The mineral clip is connected to one post and the binding-post supporting the "feeler" to the other. The tension or pressure of the end of

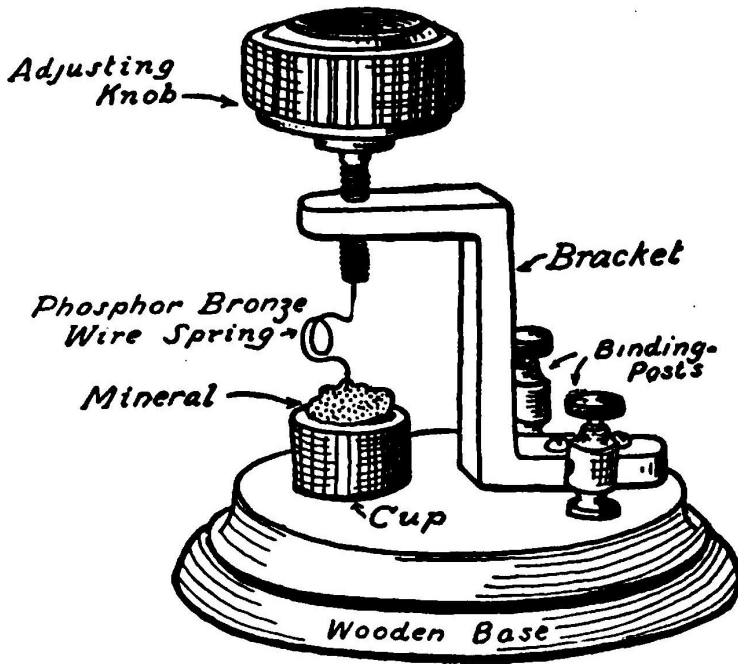

Fig. 210.—A Crystal Detector.

the fine wire upon the mineral may be regulated by twisting the electrose knob so as to twist the rod. The different portions of the crystal may be "searched" for the most sensitive spot by sliding the rod back and forth.

A somewhat similar form of cat-whisker detector is shown in Figure 213. It is provided with a cup to hold the mineral in place of a clip.

The detector shown in Figure 214 is more elaborate than any of the others described so far.

The base is a wooden block, three and one-half by one and three-quarters inches by one-half inch. The binding-posts are of the type commonly used on electrical instruments. One of the posts is pivoted so that it will swing from side to side. A short piece of brass rod fitted with a rubber or fiber knob passes through the wire hole in the post. A piece of No. 30 B. & S. gauge bronze wire is soldered to the end of the rod. A small brass cup contains the mineral, which

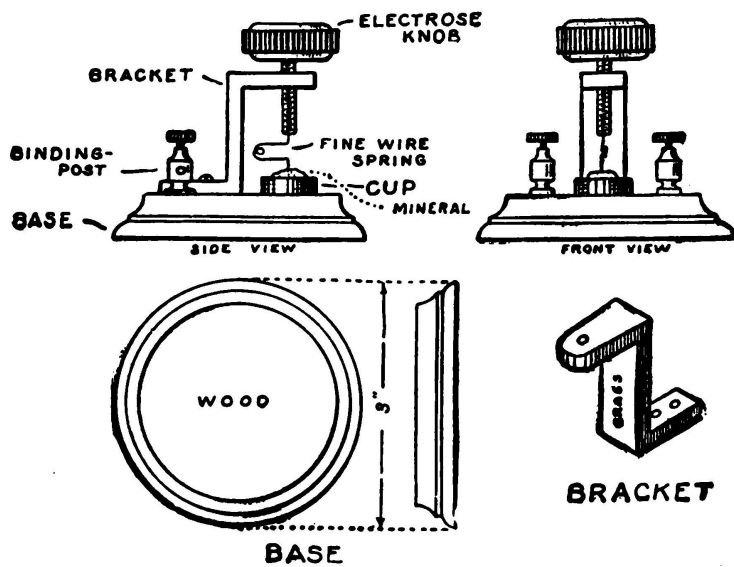
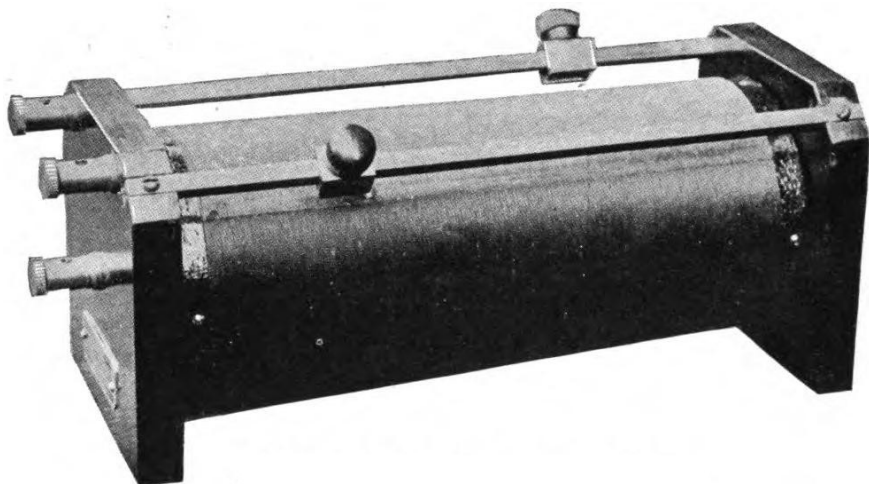
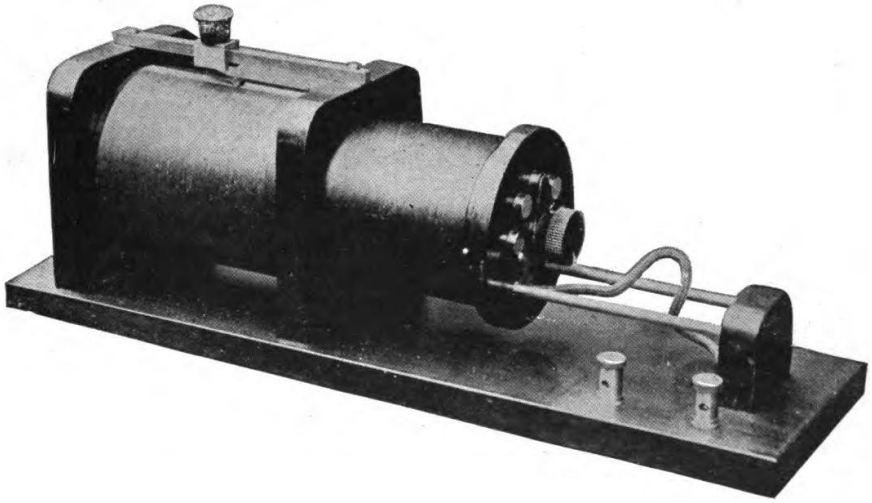

Fig. 211.—Details of the Crystal Detector.



A Double Slider Tuning Coil.



A Junior Loose Coupler.



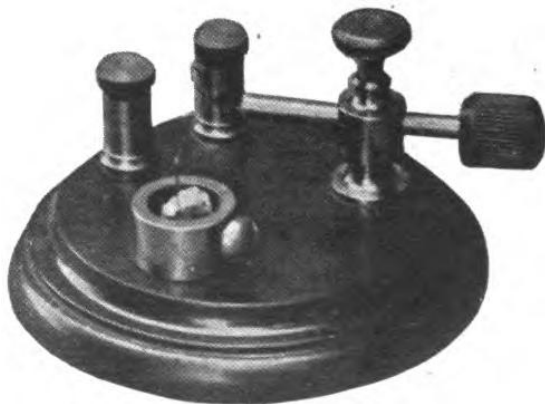

Crystal Detectors.

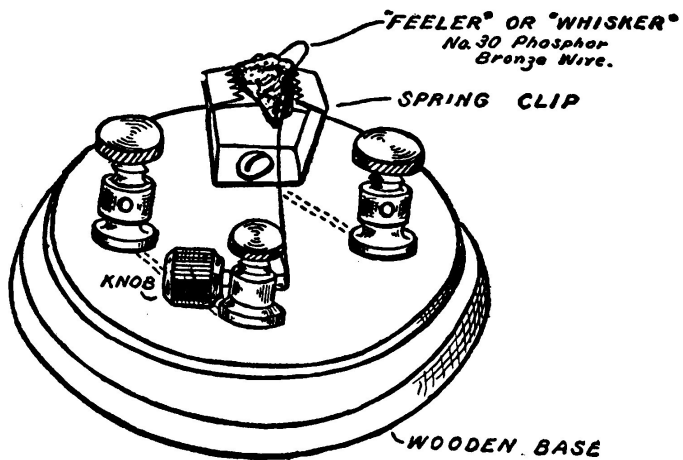

Fig. 212 Details of the "Cat Whisker" Detector.

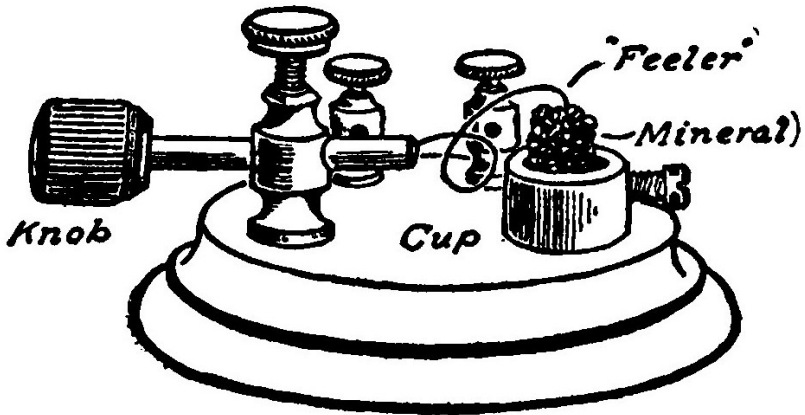

Fig. 213.—Another Form of the "Cat-Whisker" Detector.

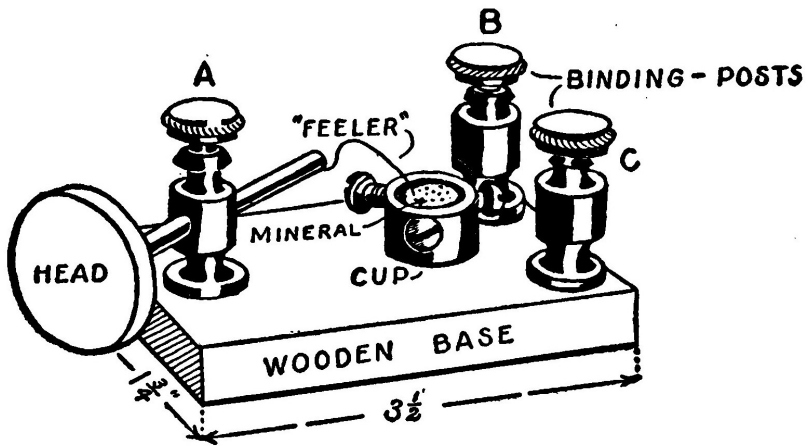

Fig. 214.—"Cat-Whisker" Detector.

may be either *galena*, or *silicon*. By twisting the post and sliding the rod back and forth, any portions of the mineral surface may be selected.

Fixed Condenser.

The construction of the condenser is illustrated in Figure 205. Take twenty-four sheets of thin typewriter paper, three by four inches, and twenty-three sheets of tinfoil, two by four inches. Pile them up, using first a sheet of paper then a sheet of tinfoil, then paper, and so on, so that every two sheets of tinfoil are separated by a sheet of paper. Each sheet of tinfoil must, however, project out beyond the edge of the paper. Connect all the tinfoil projections on one end of the condenser together and attach a small wire. Connect all those on the opposite side in a similar manner. Then fasten a couple of rubber bands around the condenser to hold it together.

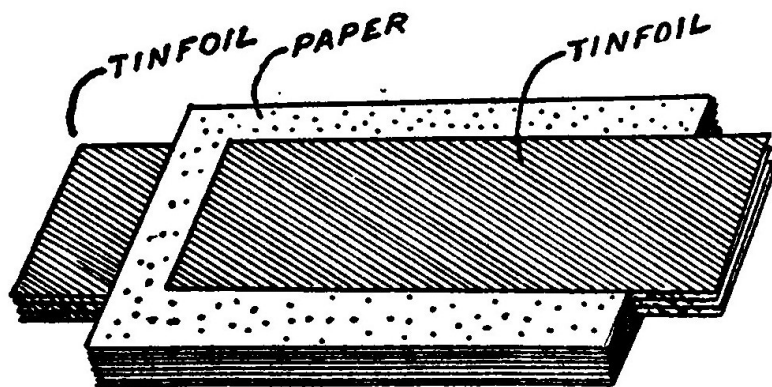

Fig. 215.—Building up a Fixed Condenser.

If it is desired to give the condenser a finished appearance, it may be placed in a brass tube fitted with two wooden or fiber ends. The ends are provided with binding-posts to which the terminals of the condenser are connected.

Telephone Receivers for use with wireless instruments must be purchased. Their construction is such that they cannot be made by the experimenter.

A seventy-five ohm, double-pole telephone receiver will do for stations not wishing to receive farther than fifty miles.

In order to secure the best results from wireless instruments, it is necessary to have receivers especially made for wireless. Each receiver should have 1000 ohms resistance. Some boys may find it necessary to purchase one receiver at a time. Two receivers, a double headband, and a double cord, forming a complete

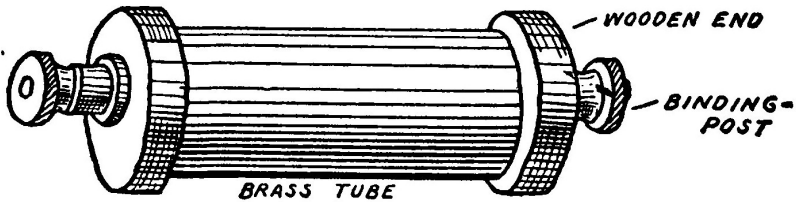

Fig. 216.—A Fixed Condenser enclosed in a Brass Case made from a Piece of Tubing fitted with Wooden Ends.

head set as shown in Figure 217, should be secured as soon as possible.

Connecting the Receiving Apparatus

Figure 218 shows how to connect a double-slide tuner, a detector, a fixed condenser and a pair of telephones to the aerial and ground. The same instruments with a loose coupler in place of the double-slide tuner are shown in Figure 219.

The diagrams in Figure 220 are the same circuits as those shown in Figures 218 and 219, but show different instruments.

After the instruments are connected, place a piece of galena or silicon in the cup of the detector and bring the wire down on it. Then move the sliders on the tuning coil or loose coupler and adjust the detector until you can hear a message buzzing in the telephones. It may require a little patience and practice, but if you persist you will soon learn how to adjust the apparatus so as to receive the signals loudly and clearly with very little trouble.

The Transmitting Apparatus

Spark coils have already been described in Chapter XII. They may be used to transmit wireless messages simply by connecting to a spark-gap and a key.

Spark coils which are especially made for wireless telegraphy will usually send farther than an ordinary spark coil used for experimental purposes.

A good one-inch coil costs from \$4.50 to \$5.00 and will send from three to five miles if used with a fair aerial.

A spark coil requires considerable current for its successful operation and will give the best results if operated on storage cells, dry cells, or bichromate cells. If dry cells are used, it is a good plan to connect them in series multiple as shown in Figure 69.

Spark-gaps may be made by mounting two double binding-posts on a

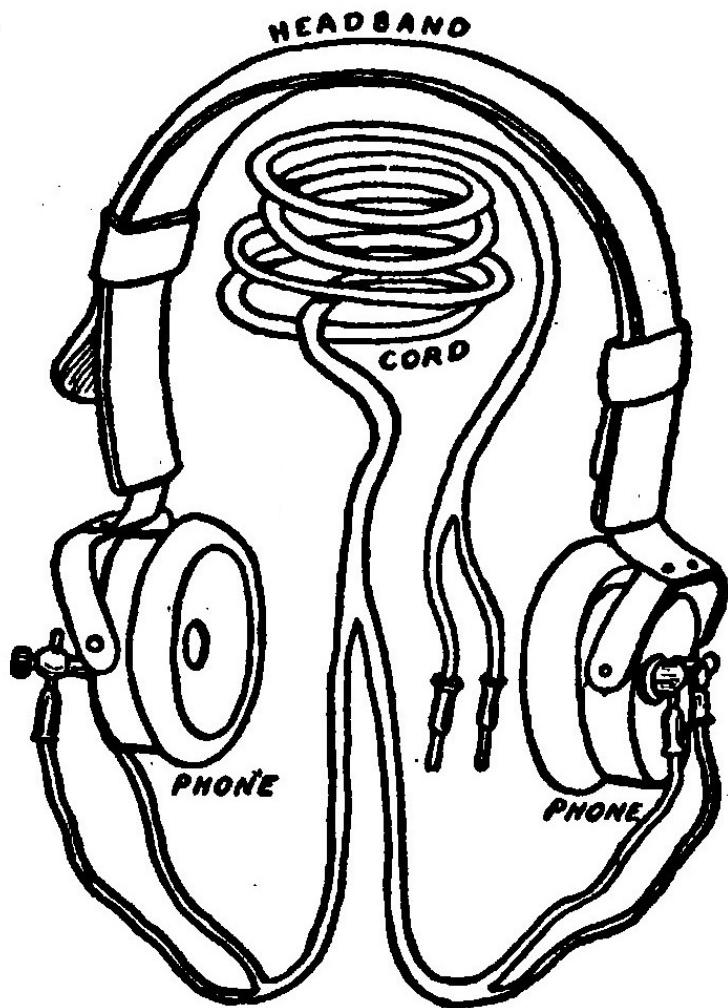

Fig. 217.—A Telephone Head Set.

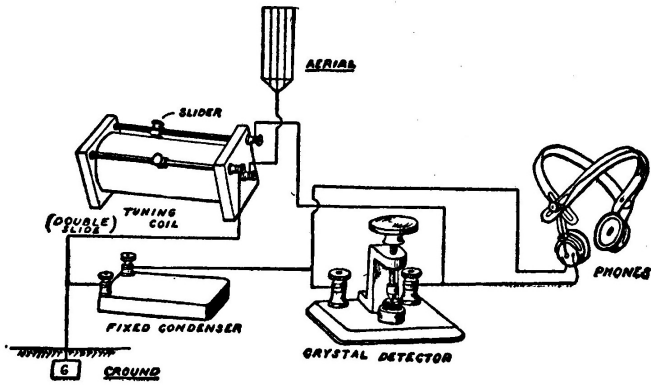

Fig. 218.—A Circuit showing how to connect a Double-Slider Tuning Coil.

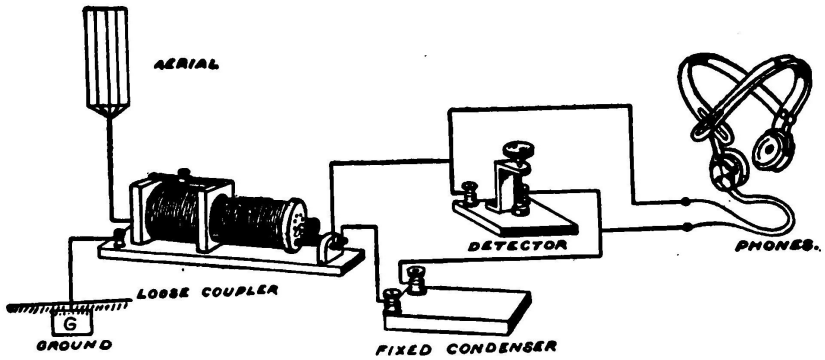

Fig. 219.—Circuit showing how to connect a Loose Coupler.

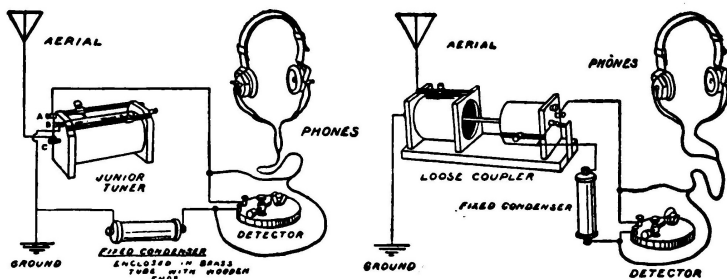

Fig. 220.—A Diagram showing how to connect some of the Instruments described in this Chapter.

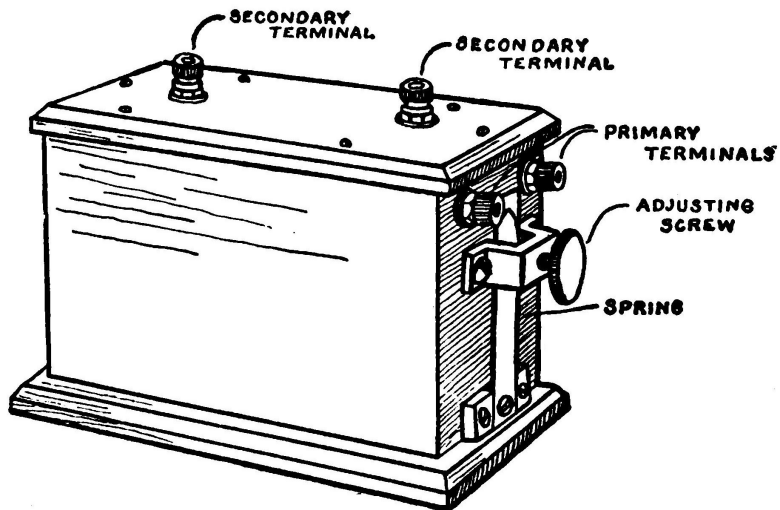

Fig. 221.—A Wireless Spark Coil.

wooden base as shown in Figure 222.

Zinc possesses some peculiar property which makes it very efficient for a spark-gap, and for this reason the electrodes of a spark-gap are usually zinc.

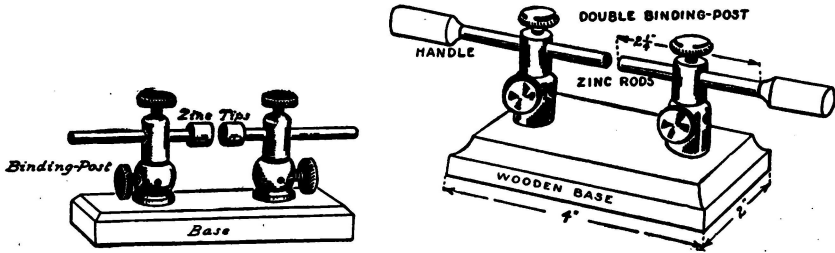

Fig. 222.—Small Spark Gaps.

The figure shows two different forms of electrodes. In one, they are made of zinc rods and provided with "electrose" handles. In the other gap, the zinc electrodes are in the shape of "tips" fitted on the ends of two short brass rods.

A one-inch spark coil will give very good results by connecting the spark-gap directly across the secondary of the coils. The aerial is connected to one side of the gap and the ground to the other.

The transmitter may be "tuned" and the range sometimes increased by using a condenser and a helix.

A condenser is most easily made by coating the inside and outside of a test-tube with tinfoil so as to form a miniature Leyden jar. The end of the tube is closed with a cork through which passes a brass rod connecting to the inner coating of tinfoil.

If such a condenser is connected directly across the spark-gap, the spark will become very white and crackling.

Several tubes may be arranged in a rack as shown in Figure 225.

A helix consists of a spiral of brass ribbon set in a wooden frame. The two strips composing the frame are each nine inches long. The spiral consists of eight turns of brass ribbon, three-eighths of an inch wide, set in saw-cuts made in the frame. A binding-post is connected to the outside end of the ribbon.

Figure 228 shows how to connect a helix and a condenser to a coil and a spark-gap.

The two clips are made by bending a strip of sheet brass and connecting a piece of flexible wire to one end.

In large stations, the best position for the clips is found by placing a "hot-

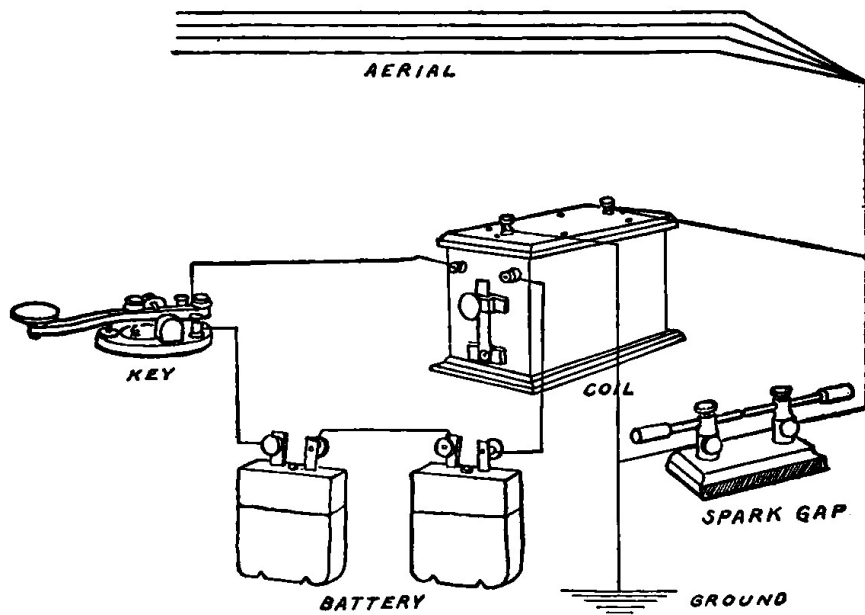

Fig. 223.—Diagram showing how to connect a Simple Transmitter.

wire ammeter” in the aerial circuit and then moving the clips until the meter shows the highest reading.

The young experimenter will have to tune his set by moving the helix clips about until the best results are obtained in sending.

If the spark coil is a good one and capable of giving a good hot spark, it may be possible to tell when the set is in proper tune by placing a small miniature tungsten lamp in series with the aerial and changing the clips, the condenser, and the length of the spark-gap until the lamp lights the brightest.

An *oscillation transformer* is sometimes used to replace an ordinary helix when it is desirable to tune a station very closely so that its messages shall not be liable to be confused with those of another station when both are working at the same time.

An oscillation transformer consists of two helixes arranged so that one acts as a primary and the other as a secondary. An oscillation helix may be made by making two sets of helix frames similar to that in Secondary Figure 226.

The primary should be provided with eight turns of brass ribbon and the

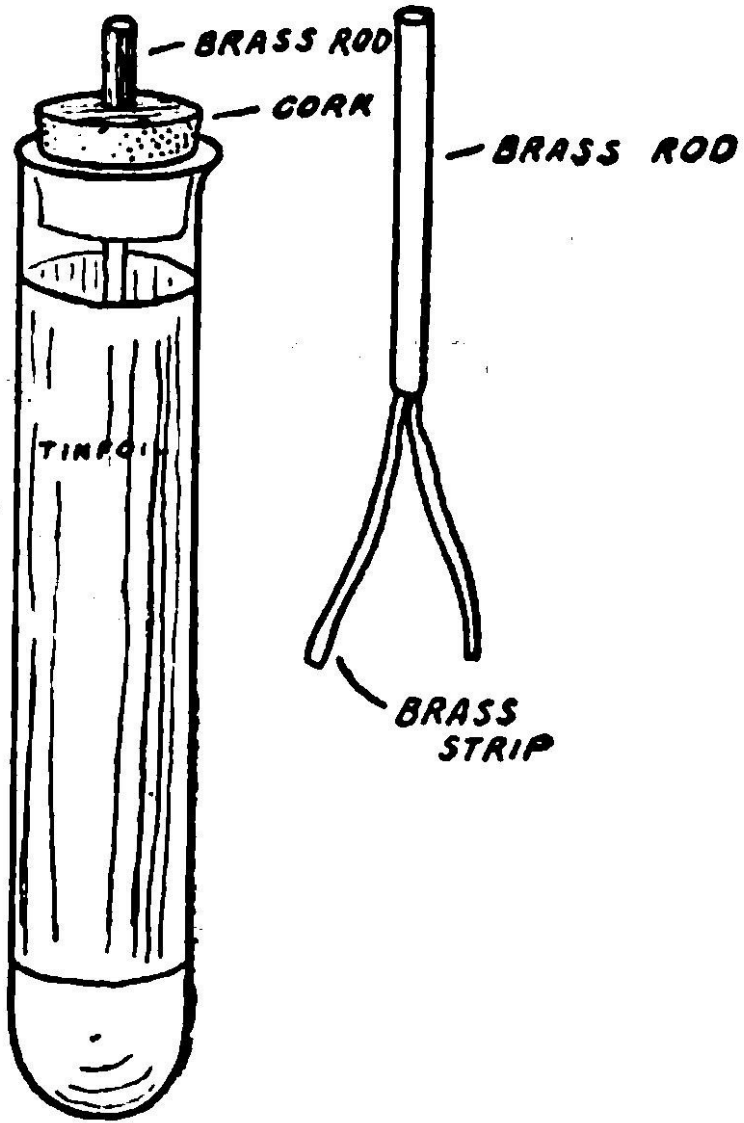

Fig. 224.—A Test-Tube Leyden Jar.

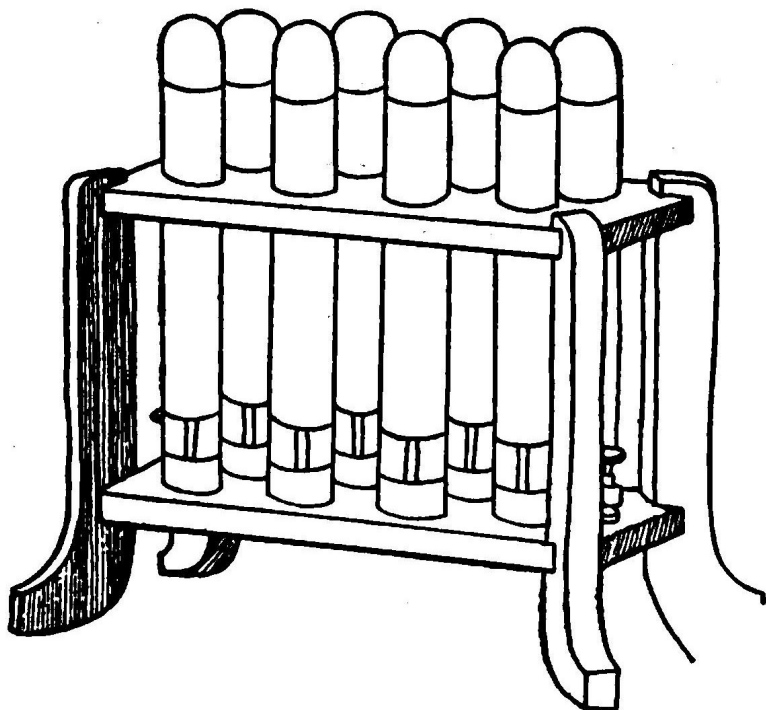

Fig. 225.—Eight Test-Tube Leyden Jars mounted in a Wooden Rack.

secondary with twelve. The primary supports a stiff brass rod upon which the secondary is mounted. The secondary should slide up and down on the rod but move very stiffly so that it will stay where it is put.

An ordinary double-throw, double-pole knife switch having a porcelain base will make a very good aerial switch in a small station. It is used to connect the aerial and ground to either the transmitting or receiving apparatus at will. Such a switch is shown in Figure 230.

The aerial should be connected to the post *A* and the ground to *B*. The posts *E* and *F* lead to the transmitter, and *C* and *D* to the receptor, or vice-versa according to which is the more convenient from the location of the apparatus on the table or operating bench.

A suitable table should be arranged to place the wireless instruments upon

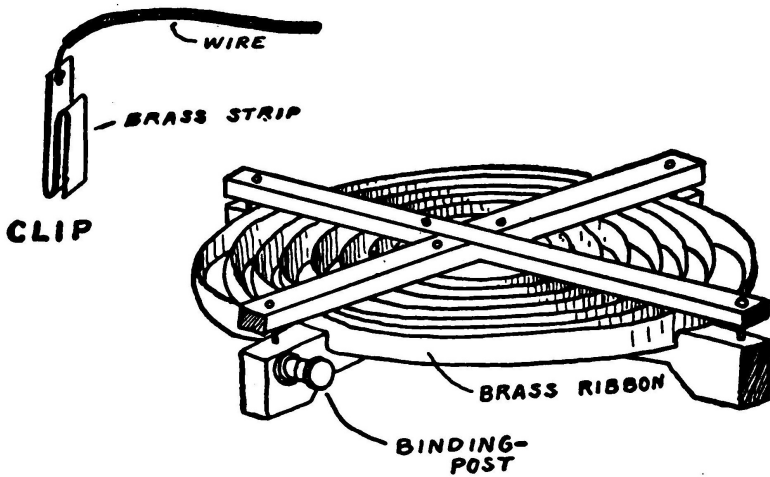

Fig. 226.—A Helix and Clip.

so that they may be permanently connected together.

The Continental Code is the one usually employed in wireless telegraphy. It differs slightly from Morse as it contains no space letters. It will be found easy to learn and somewhat easier to handle than Morse.

Two or three months' steady practice with a chum should enable the young experimenter to become a very fair wireless telegraph operator. Then by listening for some of the high power wireless stations which send out the press news to ships at sea during the evening it should be possible to become very proficient. The press news is sent more slowly than ordinary commercial wireless messages, and is therefore easy to read and a good starting point for the beginner learning to read.

A Coherer Outfit

A Coherer Outfit is usually capable of only receiving messages coming from a distance of under one mile. In spite of this fact, however, it is an exceedingly interesting apparatus to construct and experiment with, and for this reason is found fully described below.

A coherer set will ring a bell or work a sounder for short distances and therefore is the best sort of an arrangement for demonstrating the workings of your wireless apparatus to your friends.

The first thing that you need for a coherer is a pair of double binding-posts.

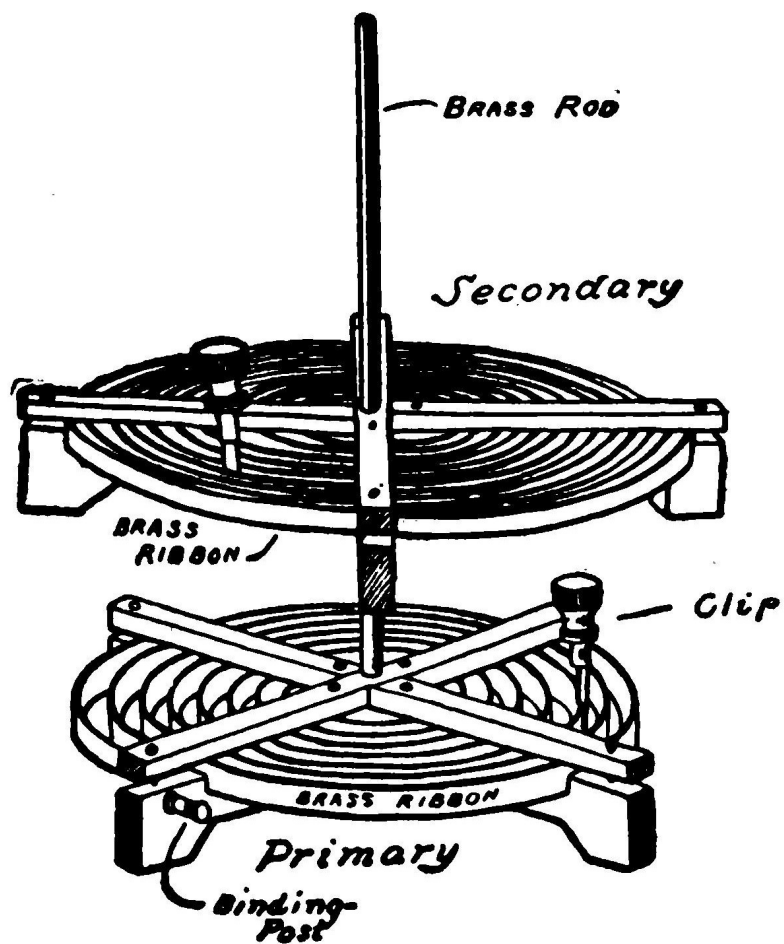
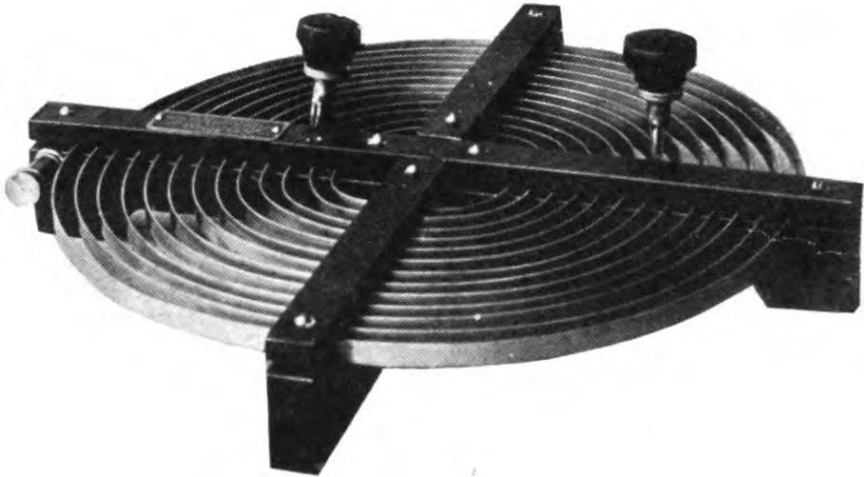

Fig. 227.—An Oscillation Transformer.



AN OSCILLATION HELIX.

Mount these about an inch and three-quarters apart on a wooden base, six inches long and four inches wide as shown in Figure 233.

Get a piece of glass tubing about an inch and one-half long and about one-eighth of an inch inside diameter. You will also need some brass rod which will just slide into the tube tightly. Cut off two pieces of the brass rod each one and three-quarters inches long and slip these through the upper holes in the binding-posts and into the glass tube as shown in Figure 234. Before putting the second rod in place, however, you must put some nickel and silver filings in the tube, so that when the rods are pushed almost together, with only a distance of about one-sixteenth of an inch between them, the filings will about half fill the space.

The filings must be very carefully prepared, and in order to make them, first use a coarse-grained file on the edge of a five-cent piece. Do not use the fine dust and powder, but only the fairly coarse filings. Mix a few silver filings from a ten-cent piece with the nickel in such proportion that the mixture is 90% nickel and 10% silver.

You will have to experiment considerably to find out just the right amount of filings to place in the tube, and how far apart to place the brass rods or plugs.

Remove the gong from an old electric bell and mount the bell on the base as shown in Figure 233. It should be in such a position that the bell hammer will touch the coherer very lightly when the bell is ringing.

The two binding-posts, tube rods, and filings constitute the *coherer*. The

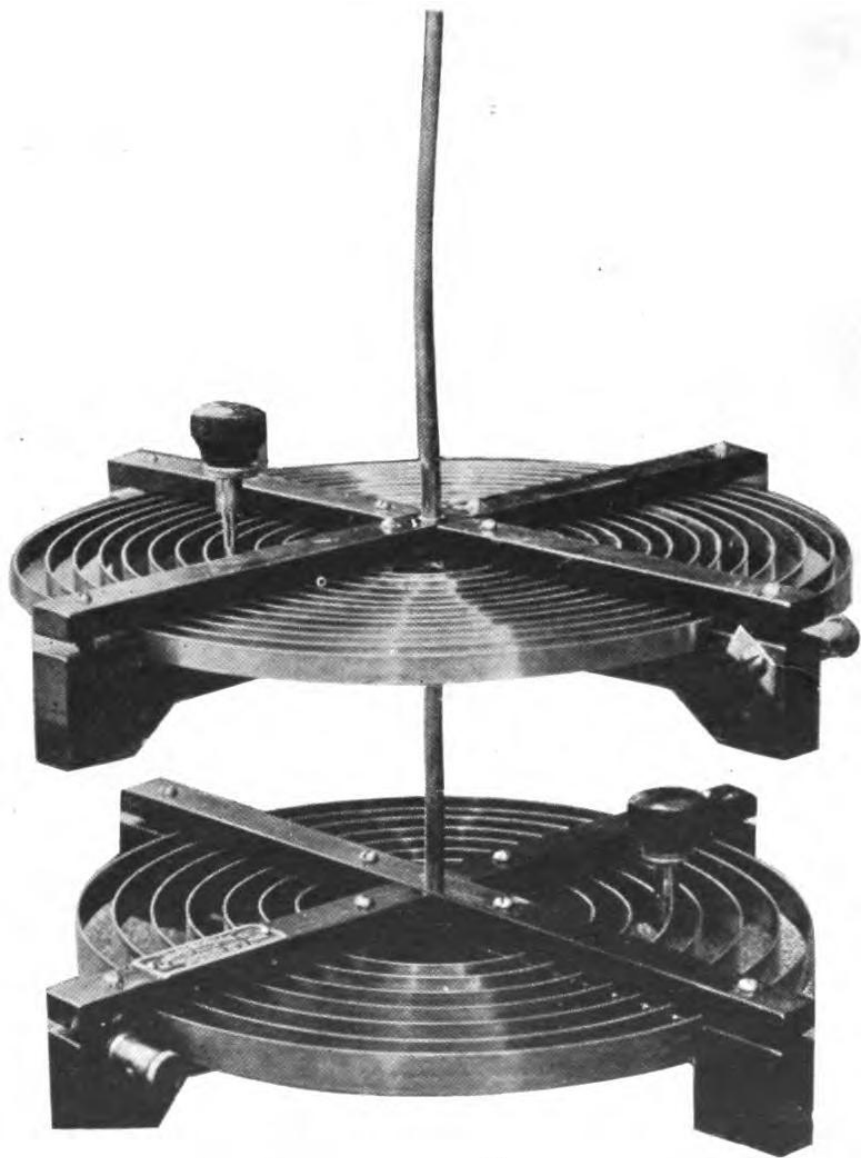

AN OSCILLATION CONDENSER.

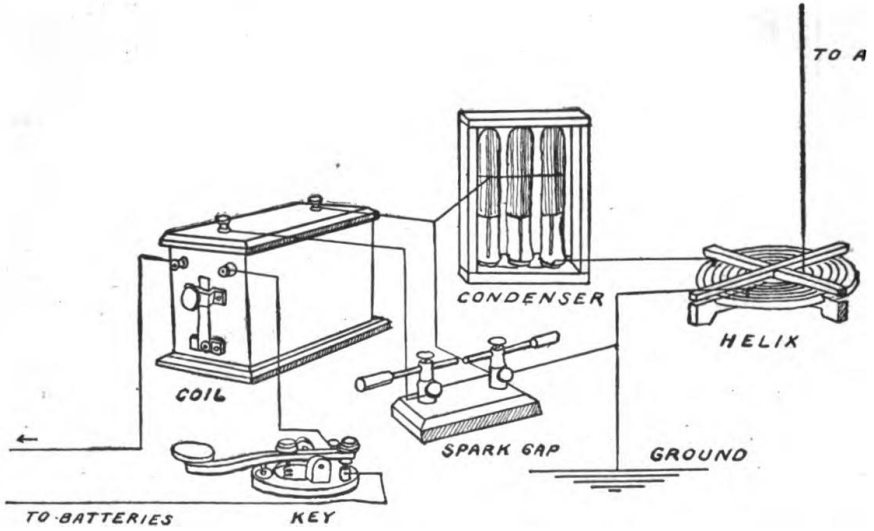

Fig 228.—Circuit showing how to connect a Helix and a Condenser.

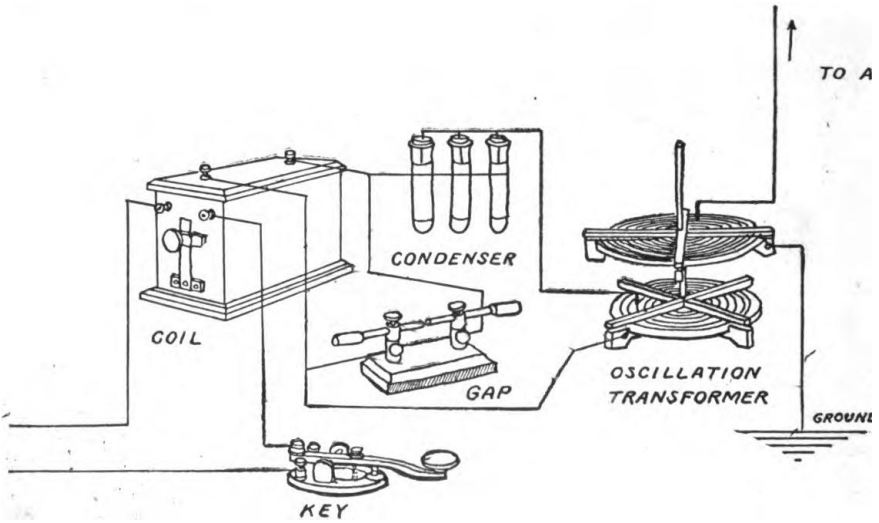

Fig 229.—Circuit showing how to connect an Oscillation Transformer and a Condenser.

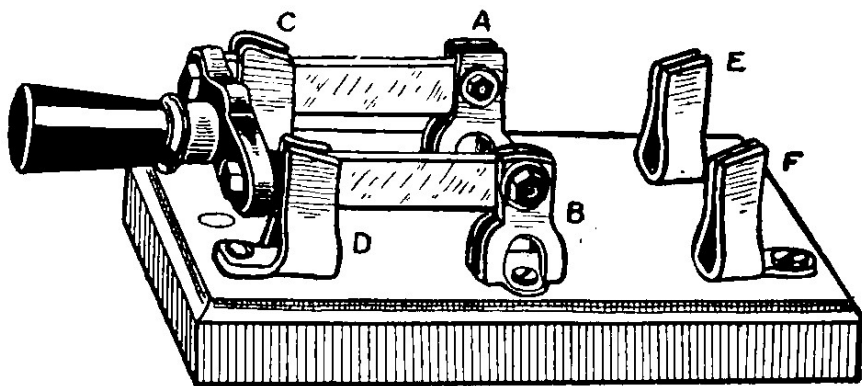

Fig 230.—An Aerial Switch.

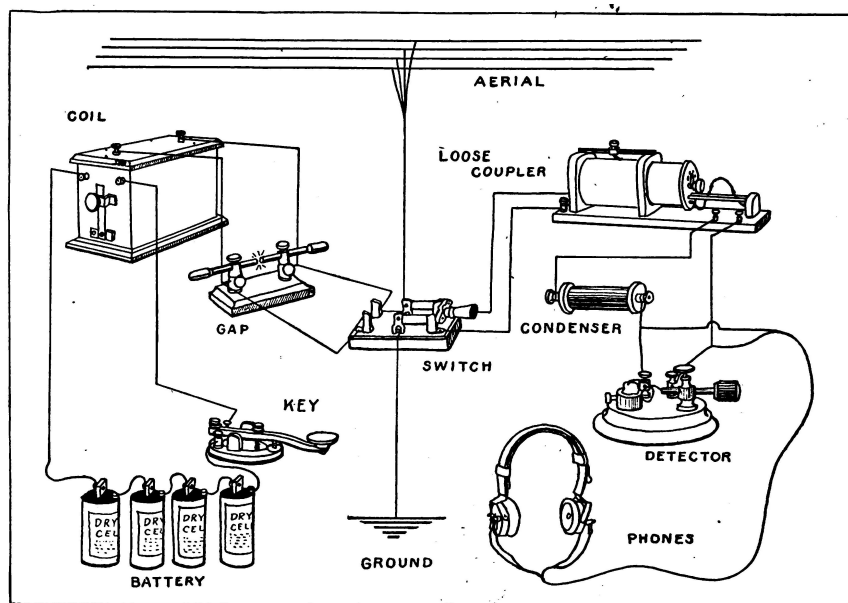

Fig 231.—A Complete Wiring Diagram for both the Transmitter and the Receptor.

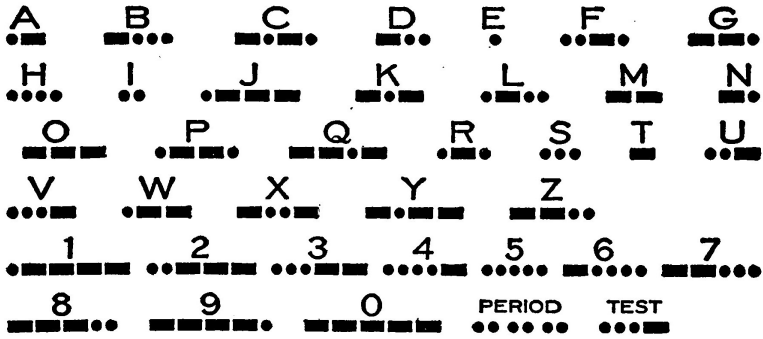

Fig. 232.—The Continental Alphabet.

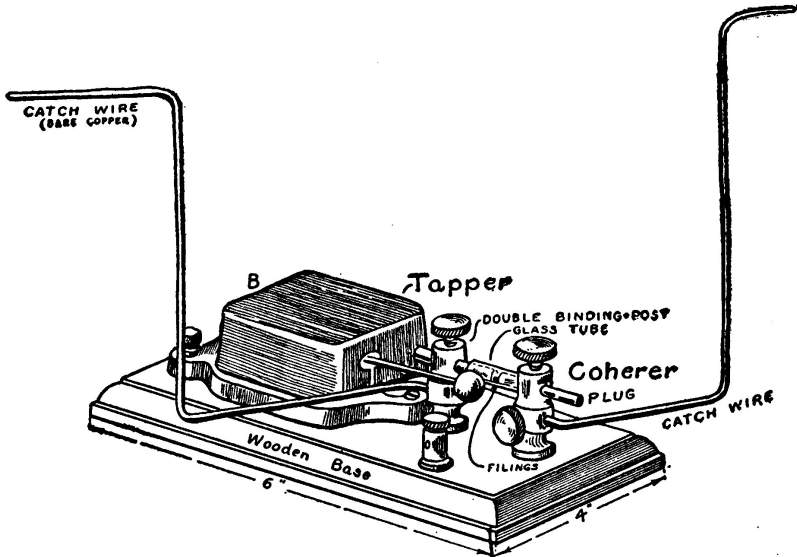

Fig. 233.—A Coherer and a Decoherer.

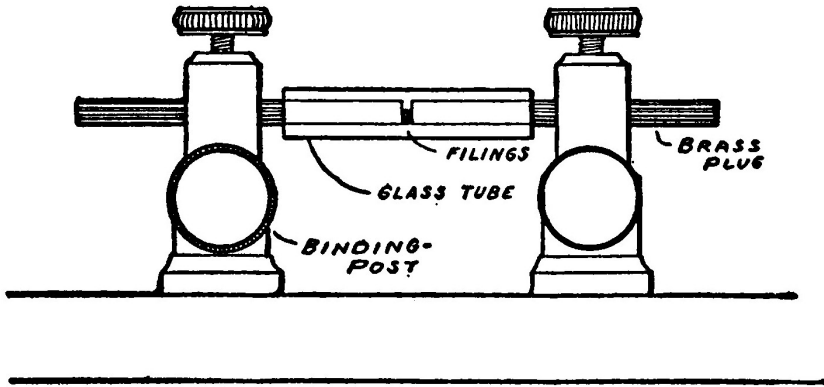

Fig. 234.—Details of the Coherer.

bell is the *decoherer*.

The next thing required in order to complete the apparatus is a relay. You may use the relay described in Chapter X or build one according to the plan shown in Figure 235. This relay consists of a single electro-magnet mounted on a wooden base, two inches wide and four inches long. The armature is a piece of soft iron rod one-quarter of an inch in diameter and one-eighth of an inch long, riveted to the end of a thin piece of spring brass, about No. 34 B. & S. gauge in thickness.

The other end of the spring is fitted to a bracket and provided with a thumb-screw to adjust the tension of the spring.

The under side of the armature and the upper side of the magnet core are each fitted with a small silver contact.

The contacts should meet squarely when the armature is drawn down on to the core by a current of electricity passing through the electro-magnet.

By turning the adjusting screw, the armature can be raised or lowered. It should be adjusted so that it almost touches the core and is only just far enough away to slip a piece of thick paper under.

The terminals of the magnet are connected to the two binding-posts on the base marked *S* and *S*. One of the binding-posts, *P*, is connected to the brass upright, and the other is connected to the core of the magnet.

Figure 236 shows how to connect up the outfit. It will require some very nice adjusting before you will be able to get it to working properly.

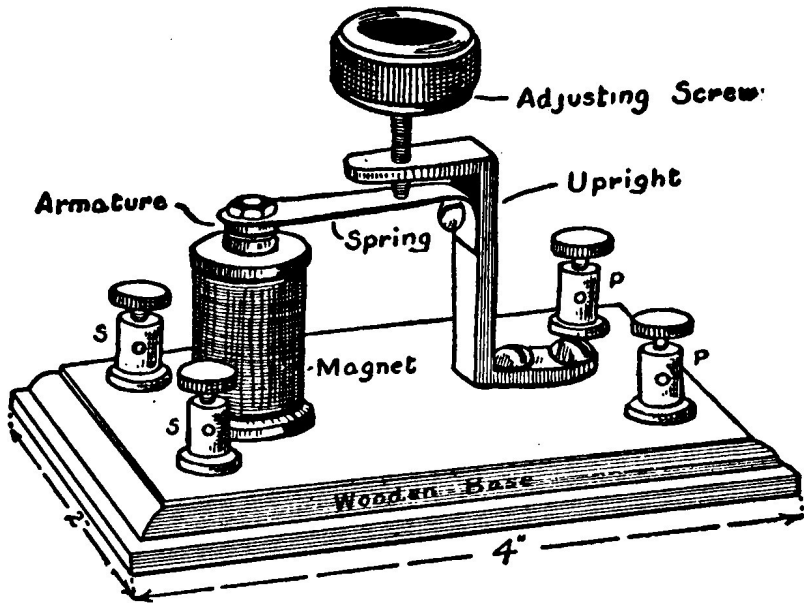

Fig. 235.—The Relay.

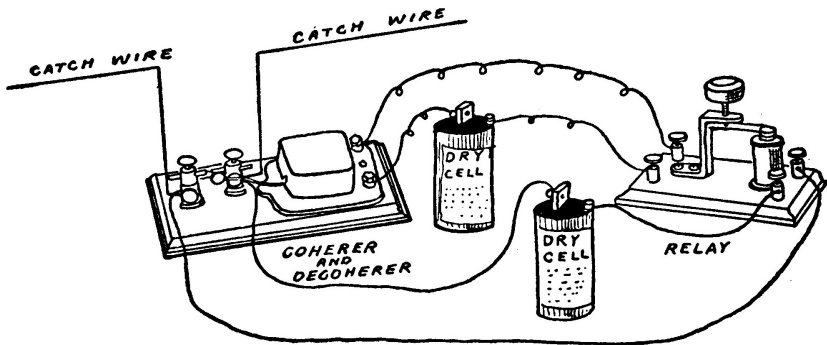

Fig. 236.—The Complete Coherer Outfit.

If you wish to use the outfit for demonstration purposes or for sending messages for very short distances, as for instance across a room, you do not need an aerial but merely a pair of "catch-wires."

The "catch-wires" are two pieces of stiff copper wire, about two feet long, placed in the lower holes in the double binding-posts forming part of the coherer.

In order to set the apparatus for operation, raise the adjusting screw of the relay until the armature is quite far away from the core. Then push the armature down against the contact on the core. The decoherer should then immediately operate and begin to tap the coherer. Then turn the thumbscrew until the armature is brought down to the core in such a position that it is as close as it is possible to get it without ringing the bell.

The transmitter should consist of a spark coil, battery, key, and a spark-gap. The gap should be connected to the secondary of the coil and adjusted so that the electrodes are only about one-eighth of an inch apart. The key is placed in series with the primary of the coil and the battery, so that pressing the key will send a stream of sparks across the gap. Fit the spark-gap with two catch-wires similar to those on the coherer and place the transmitter about four or five feet away from the coherer outfit.

You are now likely to find that if you press the key of the transmitter, the decoherer will ring. It is possible that it will continue to ring after you have stopped pressing the key. If such is the case, it will be necessary to turn the adjusting screw on the relay so as to move the armature upward a short distance away from the core.

If the decoherer will not operate each time when you press the key, the brass plugs in the coherer need adjusting. You must not be discouraged if you have some difficulty in making the apparatus work at first. After you learn how to adjust it properly, you will find that you can move the transmitter quite a distance away from the coherer and it will still operate very nicely.

After you manage that, you can place the apparatus in separate rooms and find it possible to work it just the same, because ordinary walls will not make any difference to wireless waves.

Bear in mind that the nearer the coherer plugs are to each other, the more sensitive the coherer will be, but that if too close, the decoherer will not be able to shake the filings properly and will not stop when you stop pressing the key.

The operation of the apparatus depends upon the fact that when properly adjusted the resistance of the filings between the two brass plugs is too great to allow sufficient battery current to flow to attract the armature of the relay. As soon as any wireless waves from the transmitter strike the catch-wires of the coherer, they cause the filings to cling together or cohere. When in this state, they have a low resistance and permit the current to flow in the relay circuit and

draw down the armature. The armature closes the second circuit and sets the decoherer into operation. The decoherer shakes the filings and causes them to decohere or fall apart and so makes them ready again for the next signal.

A coherer set of this sort may be used on an aerial and ground by substituting the coherer for the detector, but otherwise following any of the receiving circuits which have already been shown.

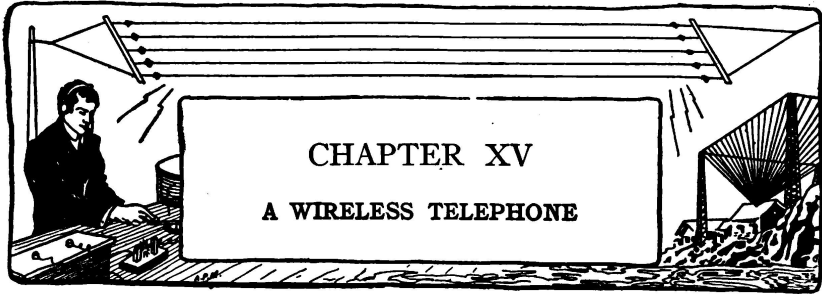

CHAPTER XV A WIRELESS TELEPHONE

Probably many readers of the "Boy Electrician" are amateur wireless operators and have constructed their own apparatus with which they are able to pick up commercial messages or communicate with other experimenters in the neighborhood, but not many have ever built a wireless telephone.

The device described in the following pages is easy to make and arrange, and will serve for some very interesting experiments.

It is of no practical value as a commercial wireless telephone, because the distance over which it will transmit speech is limited to from 250 to 300 feet. If you have a chum who lives across the street and within the distance named above, it is possible for you to construct a simple wireless telephone which will enable you to remain in your own rooms and talk to each other without any connecting wires.

The instruments operate by magnetic induction. It has already been explained how it is possible for the current in the primary of an induction coil to induce a current in the secondary coil, even though the two are not electrically connected. This type of wireless telephone really consists of an induction coil in which the two windings are widely separated.

Suppose that two coils of wire are connected as in Figure 237. The illus-

tration shows that one coil, *A*, is connected in series with a set of batteries and a telegraph key. The terminals of the other coil, *B*, are connected to a telephone receiver. The coils are placed parallel to each other and a few inches apart. If the key is pressed so that the battery current may flow through the coil, *A*, it will create a magnetic field, and lines of force will be set up in the immediate vicinity. The lines of force will pass through the coil, *B*, and induce in it a current of electricity which will cause a sound like a click to be heard in the telephone receiver.

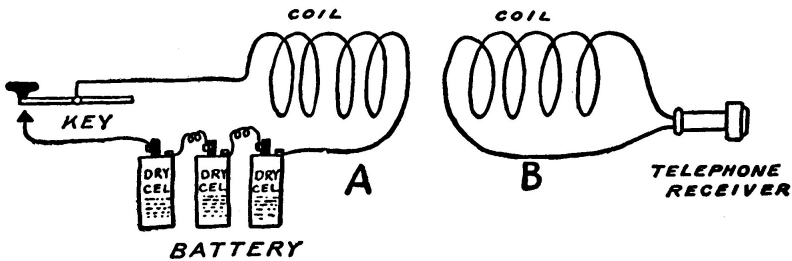

Fig. 237.—A Simple Arrangement showing the Inductive Action between two Coils.

If a telephone transmitter is substituted for the key and words are spoken into it, the current passing through the coil from the battery will vary with each vibration of the voice and the words will be distinctly repeated by the receiver connected to *B*.

This experiment may be tried by any boy with the equipment he probably has already around his shop. Twenty-five to thirty turns of wire wound around a cardboard tube five or six inches in diameter will serve as a coil. Two such coils, an ordinary telephone transmitter, a telephone receiver and a couple of dry cells are all that is required.

The diagram in the accompanying illustration shows how the apparatus is arranged. The coils may be used several inches apart and the voice will be clearly heard in the receiver.

Such an outfit is, however, only experimental, and if it is desired to make a practical set, the coils, etc., must be much larger in diameter and contain a greater number of turns.

Larger coils are made by first drawing a circle four feet in diameter on the floor of the "shop" or attic. Then drive a number of small nails around the circumference, about four inches apart.

Procure two and one-half pounds of No. 20 B. & S. gauge cotton-covered

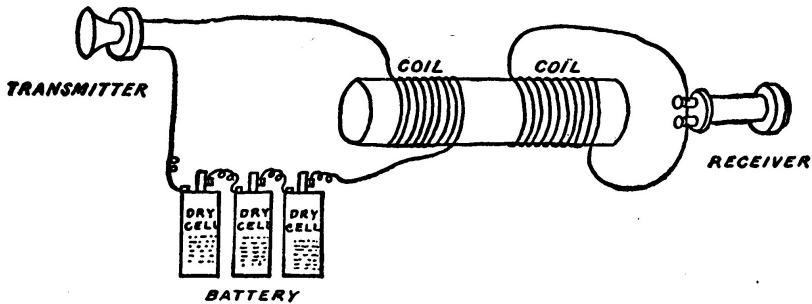

Fig. 238.—A Simple Wireless Telephone. Speech directed into the Transmitter can be heard in the Receiver, although there is no direct electrical connection between the two.

magnet wire and wind it around the circumference of the circle. The wire should form at least sixty complete turns. About one foot should be left at each end to establish connections with. After winding, the coil should be tied about every six inches with a small piece of string so that it will retain its shape and not come apart. The nails are then pulled out so that the coil may be removed.

The coil may be used just as it is for experimental purposes, but if it is intended for any amount of handling it is wise to procure a large hoop such as girls use for rolling along the sidewalk, and make the coil the same diameter as the hoop so that upon completion they may be firmly bound together with some insulating tape. Two binding-posts may then be fastened to the hoop and the terminals of the coil connected to them.

Two such coils are required for a complete wireless telephone system, one to be located at each station.

It is also necessary to make a double-contact strap-key. Such a key is easily built out of a few screws and some sheet-brass. The illustration shows the various parts and construction so clearly that no detailed explanation is necessary.

The telephone transmitter and the telephone receiver required for this experiment must be very sensitive, and it is hardly possible for the young experimenter to build one which will be satisfactory. They can be secured from a second-hand telephone or purchased at an electrical supply house. The transmitter should be of the "long distance" type. An 80-ohm receiver will serve the purpose, but if you also have a wireless station, use the same 1000-ohm receivers belonging to your wireless set and you will secure very good results.

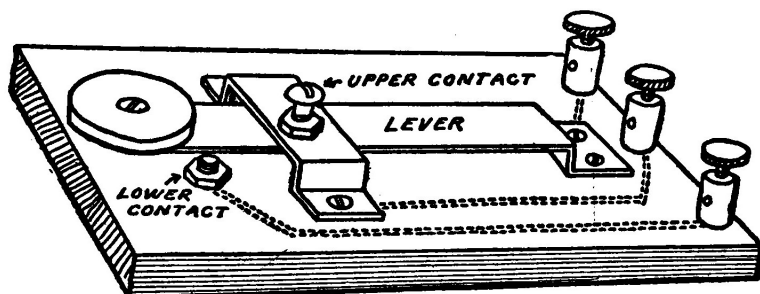

Fig. 239.—A Double-Contact Strap-Key. The Dotted Lines show how the Binding-Posts are connected.

A battery capable of delivering about 10 volts and a good constant current is required.

The apparatus is connected as shown in Figure 240.

When the key is pressed, the coil is connected to the battery and the telephone transmitter. If words are then spoken into the transmitter they will vary the amount of current flowing and the magnetic field which is set up in the neighborhood of the coil will induce currents in the coil at the other station, provided that it is not too far away, and cause the words to be reproduced in the telephone receiver.

When the key is released it will connect with the upper contact and place the telephone receiver in the circuit for receiving, so that your chum at the other station can answer your message by pressing his key and talking into his transmitter.

The best plan is to mount each of the coils upon a tripod and experiment by placing them close together at first and gradually moving them apart until the maximum distance that the apparatus will work is discovered.

Be very careful to keep the two coils exactly parallel.

Much depends upon the battery. Be certain that it is capable of delivering a good strong current. Do not hold the key down any longer than is absolutely necessary, or the telephone transmitter will become hot.

By making the coils six feet in diameter and placing from 200 to 400 turns of wire in each coil you can make a set which is capable of transmitting speech 300 feet or more.

The coil may be mounted on the wall of your shop in a position where it

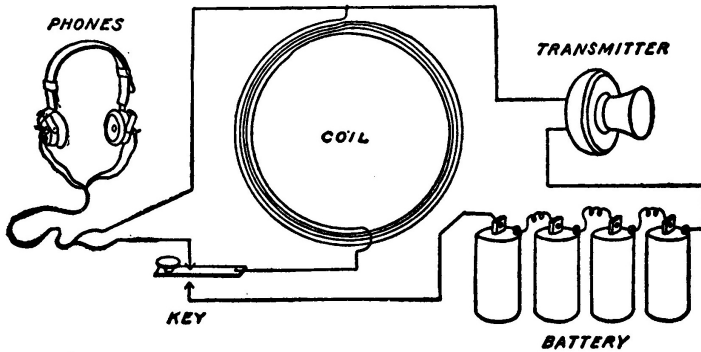

Fig. 240.—The Circuit of the Wireless Telephone. When the Key is up, the Receiver is ready for Action. When the Key is pressed, the Transmitter and Battery are thrown into the Circuit.

will be parallel to one located in your chum's house.

The success of a wireless telephone system of this sort lies in making the coils of large diameter and many turns, in keeping the coils parallel, using a sensitive transmitter and receiver, and in employing a good strong battery. Storage cells are the best for the purpose.

CHAPTER XVI ELECTRIC MOTORS

The first American patentee and builder of an electric motor was Thomas Davenport. The father of Davenport died when his son was only ten years old. This resulted in the young inventor being apprenticed to the blacksmith's trade at the age of fourteen.

Some years later, after having thoroughly learned his trade, he married a beautiful girl of seventeen, named Emily Goss, and settled in the town of Brandon, Vermont, as an independent working blacksmith.

About this time Joseph Henry invented the electro-magnet. Davenport heard of this wonderful "galvanic magnet" which it was rumored would lift a blacksmith's anvil. This was his undoing, for never again was he to know peace of mind but was destined to always be a seeker after some elusive scientific "will-o'-the-wisp." Although many times he needed iron for his shop, the greater part of his money was spent in making electro-magnets and batteries.

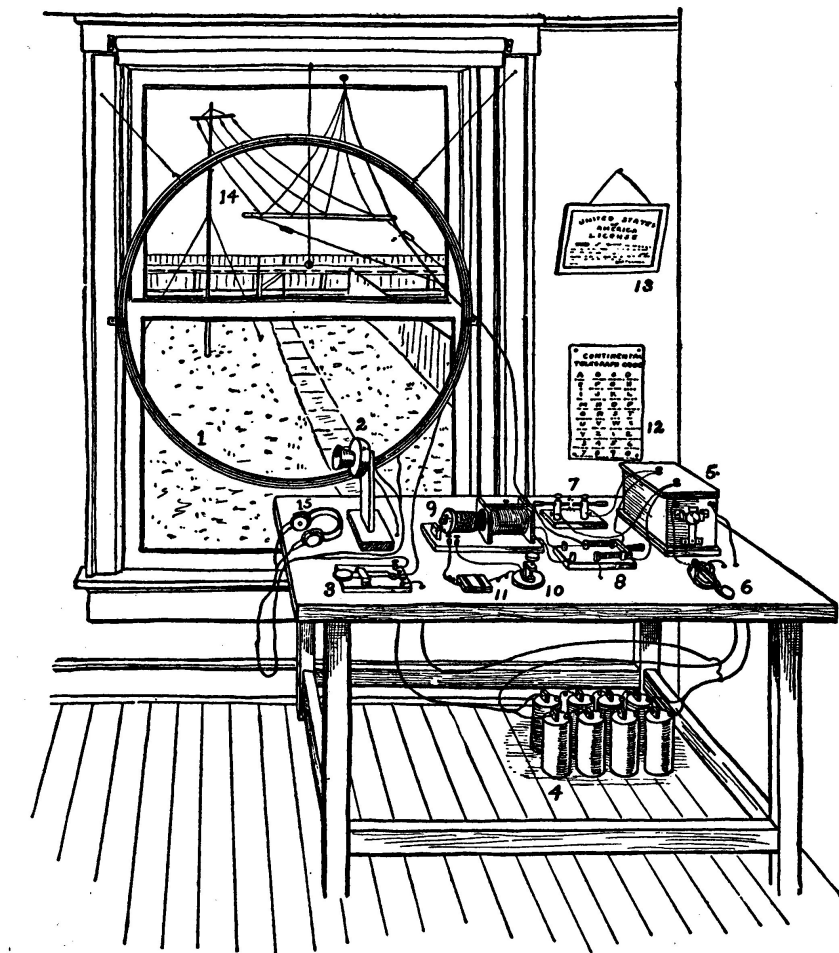
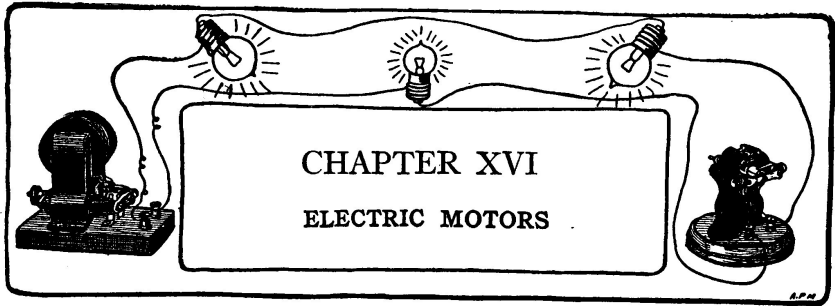

Fig. 241.—A Complete Wireless Telephone and Telegraph Station for Amateurs. 1. The Telephone Coil. 2. The Telephone Transmitter. 3. Double-Contact Strap-Key. 4. The Battery. 5. Spark Coil. 6. Key. 7. Spark-Gap. 8. Aerial Switch. 9. Loose Coupler. 10. Detector, 11. Fixed Condenser. 12. Code Chart. 13. Amateur License. 14. Aerial. 15. Telephone Receivers.



In those days insulated wire could not be purchased, and any one wishing insulated wire had to buy bare wire and insulate it himself. It was then supposed by scientists that silk was the only suitable material for insulating wire and so Davenport's brave young wife cut her silk wedding gown into narrow strips and with them wound the coils of the first electric motor.

Continuing his experiments in spite of almost insurmountable difficulties and making many sacrifices which were equally shared by his family, he was enabled to make a trip to Washington in 1835 for the purpose of taking out a patent. His errand was fruitless, however, and he was obliged to return home penniless.

Nothing daunted, he made the second and third trip and finally secured his memorable patent, the first of the long line of electric-motor patents that have made possible both the electric locomotive that hauls its long train so swiftly and silently, and the whirring little fan which stirs up a breeze during the hot and sultry days.

These are a few of the reasons why a modest country blacksmith, in turn an inventor and an editor, through perseverance in struggling against adversity and poverty succeeded in placing his name on the list which will be deservedly immortal among the scientists and engineers of the world.

A **Simple Electric Motor** can be made in fifteen minutes by following the plan shown in Figure 242.

The armature is made by sticking a pin in each end of a long cork. The pins should be as nearly central as it is possible to make them, so that when the cork is revolved upon them it will not wobble. The pins form the shaft or spindle of the motor. Then take about ten feet of fine magnet wire (Nos. 28-32 B. & S. gauge) and wind it on as shown in the illustration, winding an equal number of turns on each side of the two pins.

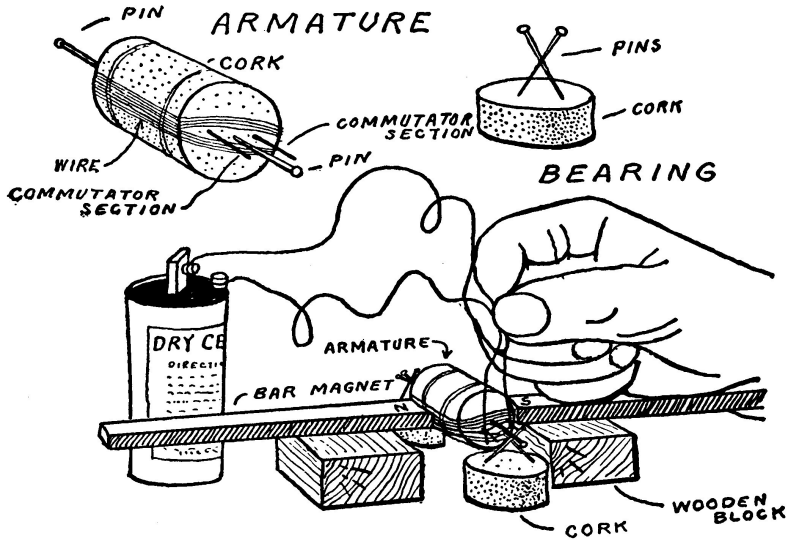

Fig. 242.—A Simple Electric Motor which may be made in Fifteen Minutes.

When this is finished, fasten the wire securely to the cork by binding it with thread.

Bend the two free ends (the starting and the finishing end) down at right angles and parallel to the shaft so as to form two commutator sections as shown in the upper left hand corner of Figure 242. Cut them off so that they only project about three-eighths of an inch. Bare the ends of the wire and clean them with a piece of fine emery paper or sandpaper.

The bearings are made by driving two pins into a couple of corks so that the pins cross each other as shown in the upper right-hand corner of Figure 242.

They must not be at too sharp an angle, or when the armature is placed in position, the friction of the shaft will be so great that it may not revolve.

The motor is assembled by placing the armature in the bearings and then mounting two bar magnets on either side of the armature. The magnets may be laid on small blocks of wood and should be so close to the armature that the latter just clears when it is spun around by hand. The north pole of one magnet should be next to the armature and the south pole of the other, opposite.

Connect two wires about one foot long and No. 26 B. & S. gauge in diameter to a dry cell. Bare the ends of the wires for about an inch and one half.

Take the ends of the two wires between the forefinger and thumb and bend them out, so that when the armature is revolved they can be made just to touch the ends of the wire on the armature, or the "commutator sections," as they are marked in the drawing.

Give the armature a twist so as to start it spinning, and hold the long wires in the hand so that they make contact with the commutator as it revolves.

Very light pressure should be used. If you press too hard, you will prevent the armature from revolving, while, on the other hand, if you do not press hard enough, the wires will not make good contact.

The armature will run in only one direction, and so try both ways. If you start it in the right direction and hold the wires properly, it will continue to revolve at a high rate of speed.

If carefully made, this little motor will reward its maker by running very nicely. Although it is of the utmost simplicity it demonstrates the same fundamental principles which are employed in real electric motors.

The **Simplex Motor** is an interesting little toy which can be made in a couple of hours, and when finished it will make an instructive model.

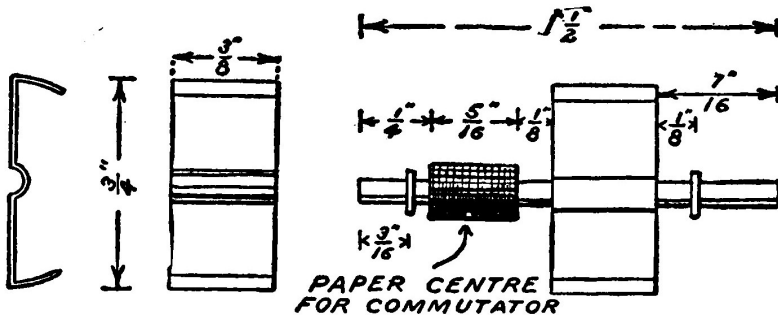

Fig. 243.—Details of the Armature of the Simplex Motor.

As a motor itself, it is not very efficient, for the amount of iron used in its construction is necessarily small. The advantage of this particular type of motor and the method of making it is that it demonstrates the actual principle and the method of application that is used in larger machines.

The field of the motor is of the type known as the "simplex" while the armature is the "Siemens H" or two-pole type. The field and the armature are cut from ordinary tin-plated iron such as is used in the manufacture of tin cans and cracker-boxes.

The simplest method of securing good flat material is to get some old scrap from a plumbing shop. An old cocoa tin or baking-powder can may, however, be cut up and flattened and will then serve the purpose almost as well.

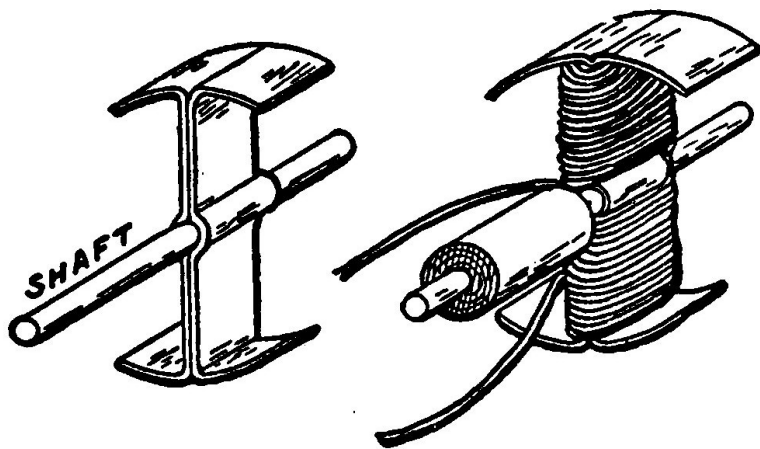

Fig. 244.—The Armature.

The Armature. Two strips of tin, three-eighths of an inch by one and one-half inches, are cut to form the armature. They are slightly longer than will actually be necessary, but are cut to length after the finish of the bending operations. Mark a line carefully across the center of each strip. Then, taking care to keep the shape symmetrical so that both pieces are exactly alike, bend them into the shape shown in Figure 243. The small bend in the center is most easily made by bending the strip over a knitting-needle and then bending it back to the required extent.

A piece of knitting-needle one and one-half inches long is required for the shaft. Bind the two halves of the armature together in the position shown in Figure 249. Bind them with a piece of iron wire and solder them together. The wire should be removed after they are soldered.

The Field Magnet is made by first cutting out a strip of tin one-half by four and then bending it into the shape shown in Figure 245.

The easiest way of doing this with accuracy is to cut out a piece of wood as a form, and bend the tin over the form. The dimensions shown in Figure 245 should be used as a guide for the form.

Two small holes should be bored in the feet of the field magnet to receive

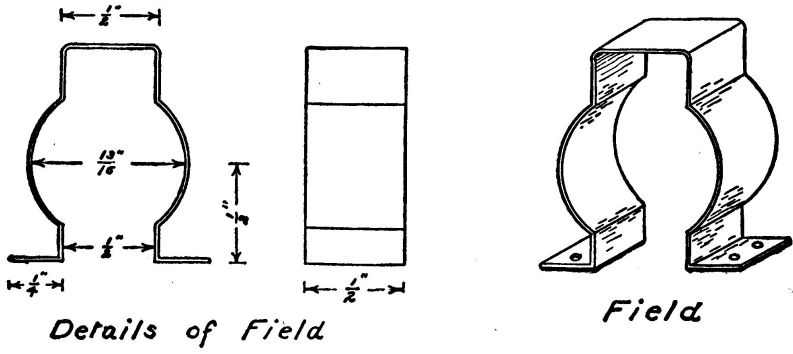

Fig. 245.—The Field.

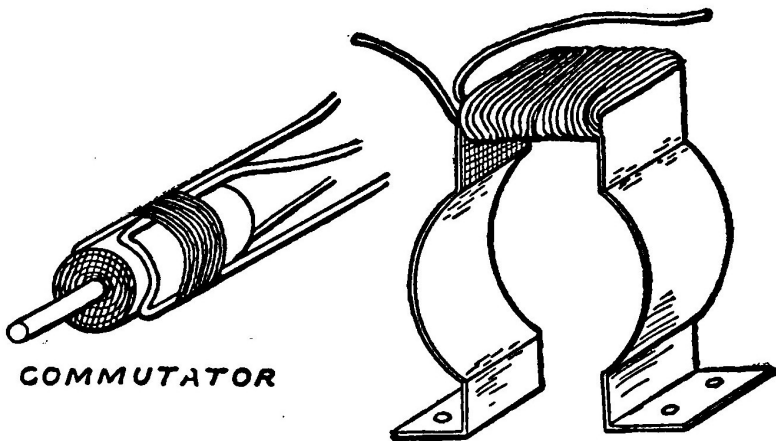

Fig. 246.—The Field and Commutator.

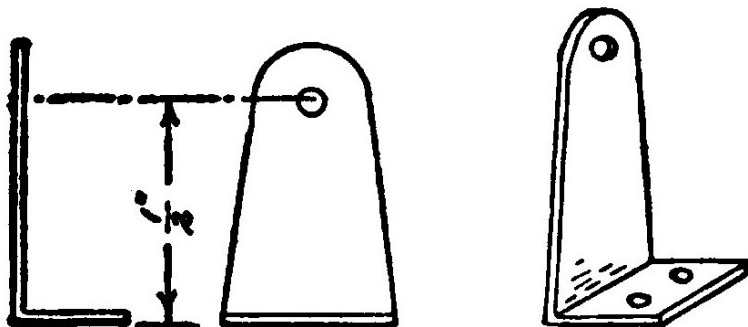

Fig. 247.—The Bearings.

No. 3 wood screws, which fasten the field to the base.

The Bearings are shown in detail in Figure 247. They are easily made by cutting from sheet-tin. Two small washers, serving as collars, should be soldered to the shaft as shown in Figure 243.

The Commutator Core is formed by cutting a strip of paper five-sixteenths of an inch wide and about five inches long. It should be given a coat of shellac on one side and allowed to get sticky. The strip is then wrapped around the shaft until its diameter is three-sixteenths of an inch.

The Base is cut from any ordinary piece of wood and is in the form of a block about two by one and one-half by one-half inch.

Assembling the Motor. The parts must be carefully prepared for winding by covering with paper. Cut a strip of paper one-half inch wide and one and one-eighth of an inch long and give it a coat of shellac on one side. As soon as it becomes sticky, wrap it around the top bar of the field magnet. The armature is insulated in exactly the same way, taking care that the paper covers the entire flat portion.

The field and armature are now ready for winding. It is necessary to take proper precautions to prevent the first turn from slipping out of place.

This is accomplished by looping a small piece of tape or cord over it. The next two turns are then taken over the ends of the loop so as to embed them. Wind on three layers of wire and when in the middle of the fourth layer embed the ends of another loop, which may be used at the end of the fourth layer to fasten the end so that it will not unwind. After the winding is finished, give it a coat of shellac.

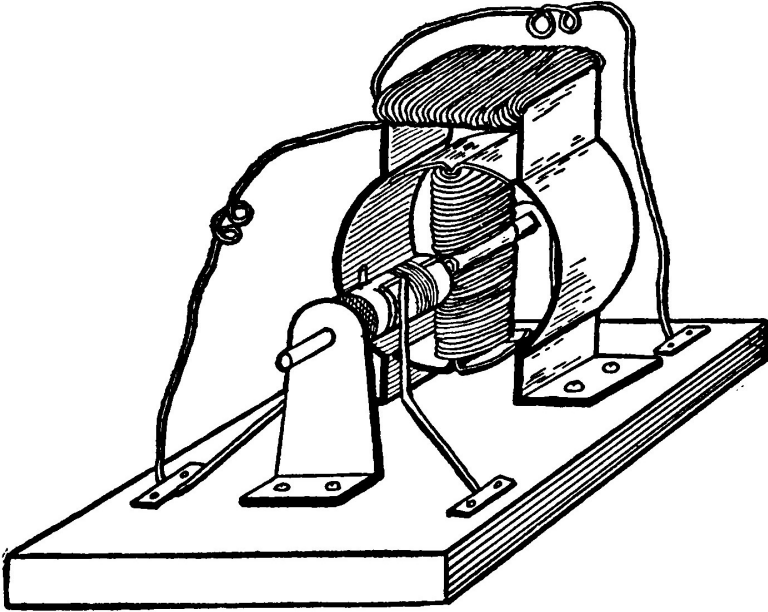

Fig. 248.—The Complete Motor.

The winding of the armature is somewhat more difficult.

The wire used for winding both the armature and the field should be No. 25 or No. 26 B. & S. gauge double-cotton-covered.

In order to wind the armature, cut off about five feet of wire and double it back to find the center. Then place the wire diagonally across the center of the armature so that there is an equal length on both sides. Place a piece of paper under the wire at the crossing point to insulate it. Then, using one end of the wire, wind four layers on half of the armature. Tie the end down with a piece of thread and wind on the other half.

The ends of the wire are cut and scraped to form the commutator segments. Figure 246 shows how this is done.

Bend the wires as shown so that they will fit closely to the paper core. Bind them tightly into position with some silk thread. Use care so that the two wires do not touch each other. Cut the free ends of the wires off close to the core.

When finished, the relative positions of the armature and the commutator should be as shown in Figure 248.

The brushes are made by flattening a piece of wire by a few light hammer blows.

The brushes are fastened under a small clamp formed by a strip of tin held down at each end with a wood screw. They can be adjusted to the best advantage only under actual working conditions when the current is passing through the motor. One or two dry cells should be sufficient to operate the motor.

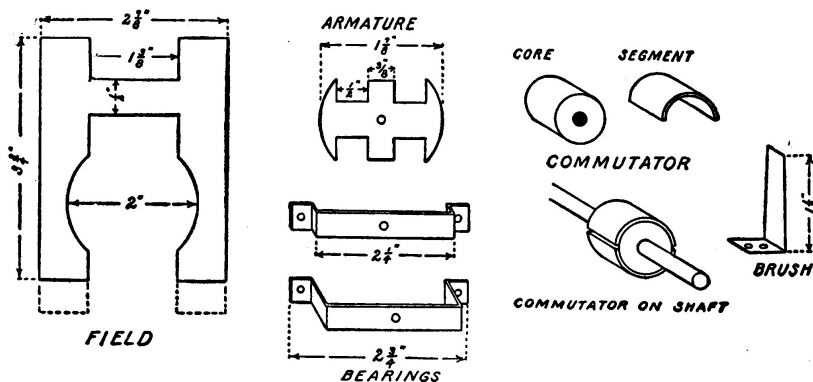

Fig. 249.—Details of the Motor.

One end of the field winding is connected to one of the brushes. The other brush and the other end of the field form the terminals to which the battery is connected.

The motor, being of the two-pole armature type, must be started when the current is turned on by giving it a twist with the fingers.

A Larger Motor may be built in somewhat the same manner as the one just described by cutting armature and field out of sheet tin. It will be more substantial if it is built up out of laminations and not bent into shape, as in the case of the other.

Lay out an armature disk and a field lamination on a sheet of tin in accordance with the dimensions and pattern shown in Figure 249. These pieces are used as patterns for laying out the rest of the laminations.

Place them on some thin sheet-iron and trace the outline with a sharp-pointed needle. Then cut a sufficient number of pieces of each pattern to form a pile three-quarters of an inch thick.

Four laminations for the field should be cut with extensions shown by the dotted lines. They are bent out at right angles for mounting the motor and hold-

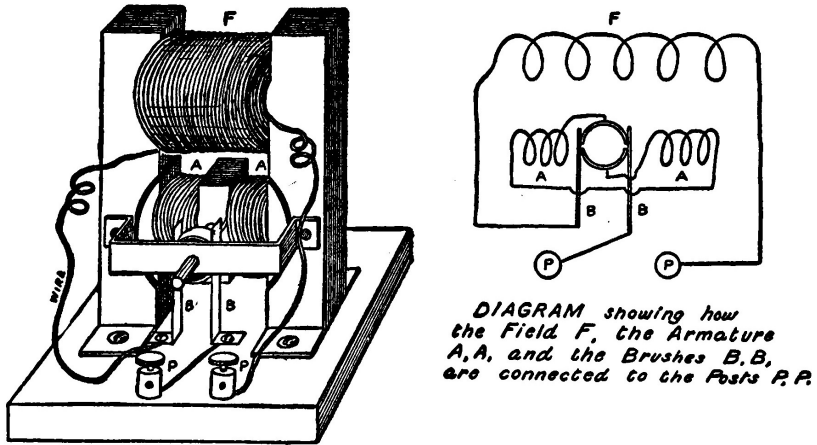

Fig. 250.—Complete Motor.

ing it upright.

Assemble the armature and field by piling the pieces on top of each other and truing them up. Enough laminations should be used to form a pile three-quarters of an inch thick when piled up and clamped tightly.

File off any burrs and rough edges and then bind the laminations together with some string to hold them until wound.

Wrap a couple of layers of paper around those portions of the armature and field which are liable to come into contact with the iron. Five or six layers of No. 18 B. & S. gauge double-cotton-covered magnet wire are sufficient to form the field coil.

The armature is wound with three or four layers of wire of the same size.

The commutator is made out of a circular piece of hard wood or fiber, fitted with segments cut out of thin sheet-copper. The segments may be fastened to the core with thick shellac or some melted sealing-wax. The ends may be bound down tightly by wrapping with silk thread.

The brushes are cut out of thin sheet-copper similar to that used for the commutator segments.

The bearings are strips of heavy sheet-brass bent into the shape shown. They are mounted by passing a nail through the holes in the ends and through the holes, A and B, in the field and then riveting the ends over.

Assemble the motor as shown in Figure 255. If desirable, a small pulley may be fitted to the shaft and the motor used to run small mechanical toys. If it is properly constructed, two or three dry cells will furnish sufficient current to run the motor at high speed.

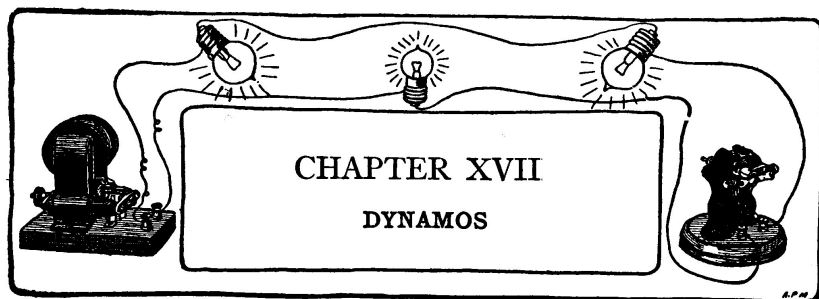

CHAPTER XVII DYNAMOS

There is perhaps no other electrical device entering into the young experimenter's domain requiring the careful workmanship and tool facilities that the dynamo does. In order to construct a practical working dynamo it would be necessary to have at hand a lathe for turning the castings.

Rather than describe a machine which comparatively few of my readers would be able to build, I have explained below how it is possible to so alter an old telephone magneto that it may be made to serve as a small dynamo. Telephone magnetos, also sometimes called hand generators, are used in many telephone systems to supply the current which rings the telephone bell at the other end. The magneto is placed in a small box on the telephone, only the handle being exposed. In order to make a call the handle is given several brisk turns before raising the receiver. When the handle is turned the moving parts of the generator revolve and produce a current of electricity which goes forth over the line and rings the bell at the other end.

Telephone magnetos are gradually being discarded in all the large telephone systems, a method known as "central energy," in which the current for ringing bells is supplied from the central office, taking their place. For that reason, there are a great many telephone magnetos to be found in second-hand shops and at electrical houses, where they can be purchased for a fractional part of the original cost. Fifty cents will buy a first-class second-hand telephone magneto.

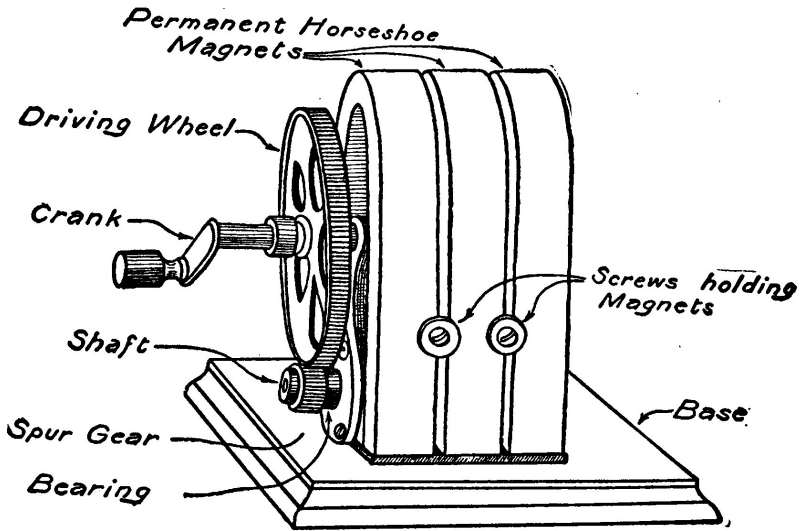

Fig. 251—A Telephone Magneto.

The author saw a pile of telephones as large as a haystack, each telephone containing a magneto, in the back yard of a second-hand shop, and the owner would have been glad to sell the complete instruments for fifty cents each.

Before explaining how to reconstruct such a machine, it is best to impress upon the reader that a careful study of the principles of the dynamo is well worth the time spent.

Almost any book on physics or electricity, or even the encyclopedia, will be found to contain a description of this wonderful machine that supplies the power for running the trolley cars, electric lights, etc., in fact all of the electricity in use to-day with the exception of that generated by batteries for telegraph and telephone lines.

It will be remembered that if a bar magnet is suddenly plunged into a hollow coil of wire, a momentary electric current will be generated in the coil. The current is easily detected by means of an instrument called a galvanometer. The space in the vicinity of a magnet is filled with a peculiar invisible force called magnetism. The magnetism flows along a certain path, passing through the magnet itself and then spreading out in curved lines. If a sheet of paper is laid over a magnet and a few iron filings are sprinkled on the paper, they will follow the

magnetic lines of force.

When the magnet is plunged into the hollow coil, the lines of force flow through the turns of wire, or are said to cut them. Whenever lines of force cut a coil of wire and they are in motion, electricity is produced. It does not matter whether the coil is slipped over the magnet or the magnet is plunged into the coil, a current will be produced as long as they are in motion. As soon as the magnet or the coil stops moving the current stops.

By arranging a coil of wire between the poles of a horse-shoe magnet so that it can be made to revolve, the motion can be made continuous and the current of electricity maintained.

Figure 252 shows such an arrangement. Some means of connection with the coil of wire must be established so that the current can be led off. If two metal rings are connected to the ends of the coil, connection can be made by little strips of metal called brushes rubbing against the rings. This scheme is the principle of the telephone magneto and the basis of all dynamos.

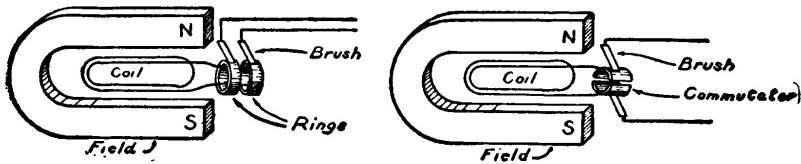

Fig. 252.—The Principle of the Alternator and the Direct-Current Dynamo.

In the telephone magneto, more than one horseshoe magnet is usually provided. The coil of wire revolves between the poles of the magnets. The coil is wound around an iron frame and together they are called the armature. The end of the armature shaft is fitted with a small spur gear meshing with a larger gear bearing a crank, so that when the crank is turned the motion is multiplied and the armature is caused to revolve rapidly. One end of the coil or armature winding is connected to a small brass pin. This pin connects with a second pin set in the end of the shaft in an insulating brush of hard rubber. The other terminal of the coil is connected to the armature itself. Thus connection can be had to the coil by connecting a wire to the frame of the machine and to the insulated pin.

The armature of a magneto is usually wound with a very fine silk insulated wire, about No. 36 B. & S. gauge in size. This should be carefully removed and wound upon a spool for future use. Replace the wire with some ordinary cotton-covered magnet wire, about No. 24 or 25 B. & S. gauge, winding it on

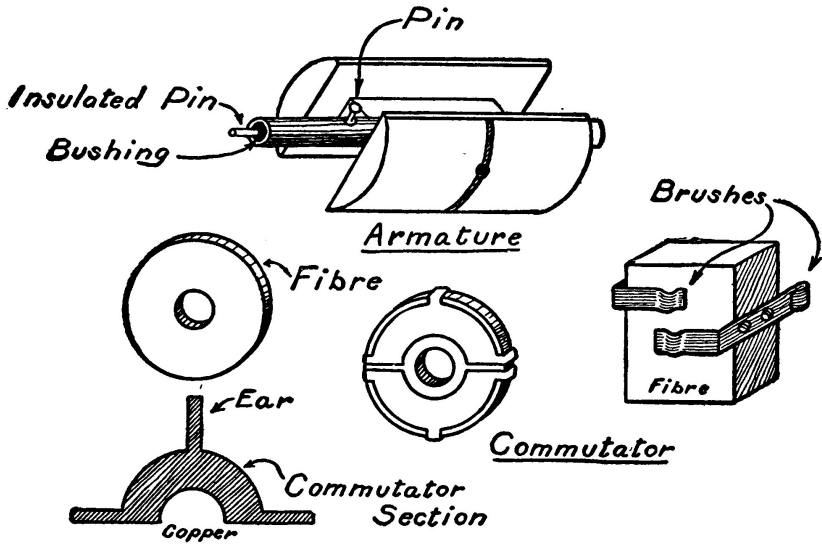

Fig. 253.—Details of the Armature, Commutator, and Brushes.

very carefully and smoothly. Connect one end of the winding to the pin leading to the insulated pin by soldering it. This pin is the one at the end of the shaft opposite to that one to which the spur gear is fastened. Connect the other end of the wire to the pin at the same end of the shaft as the gear. This pin is grounded, that is, connected to the frame.

An ordinary telephone magneto gives a very high voltage current. The voltage may vary from twenty-five to several hundred, depending upon how fast the machine is run. This is due to the fact that the armature winding is composed of a very large number of turns of wire. The more turns that are placed on the armature, the higher its voltage will be. The current or amperage of a large telephone magneto wound with a large number of turns of fine wire is very low. Too low in fact to be used for anything except ringing a bell or testing. Winding the armature with fewer turns of large wire reduces the voltage and increases the amperage so that the current will light a small lamp or may be used for other purposes. The winding does not change the principle of the magneto, it merely changes its amperage and voltage.

The magneto may be mounted on a wooden base-board and screwed to a table, so that the handle may be turned without inconvenience. A small strip of

copper, called a brush, should be fastened to the base with a screw and brought to bear against the end of the insulated pin. The brush should be connected to a binding-post with a piece of wire. A second wire leading to a binding-post should be connected to the frame of the magneto. When the handle is turned rapidly, currents may be drawn from the two binding-posts.

The current is of the kind known as alternating, that is to say, it flows first in one direction, then reverses and flows in the other.

In order to make the machine give direct current, it must be fitted with a commutator. This is somewhat difficult with some magnetos but the following plan may be carried out in most cases. Cut a small fiber circle or disk about one inch in diameter from sheet fiber three-sixteenths of an inch thick. Cut a small hole in the center, just large enough so that the fiber will slip very lightly over the end of the shaft from which the insulated pin projects. Two small commutator sections similar to that shown in Figure 253 must be cut from sheet-brass or sheet-copper. The three long ears shown in the drawing are bent back around the fiber and squeezed down flat with a pair of pincers so that they grip the fiber very tightly and will not slip. One ear on one section should be bent over the back down to the hole, where it will connect with the shaft. The other section of the commutator is connected to the insulated pin by a drop of solder. In this manner, one end of the winding is connected to one section of the commutator and the other end to the other section. The commutator should fit tightly on the end of the shaft so that it will not twist. The dividing line between the section should be parallel to a line drawn to the axis of the actual armature coil. When the iron parts of the armature are nearest the poles of the horseshoe magnets in their revolution, the slot in the commutator should be horizontal.

When the magnet is provided with a commutator, it may also be run as a motor by connecting it to a battery. In order to operate it either as a dynamo or a motor, however, it must first be fitted with a pair of brushes. They are shown in detail in Figure 253. They are made from two small strips of sheet-copper bent as shown and mounted on a small wooden block. They must be adjusted to bear against the commutator so that when the dividing line between the two sections is horizontal, the upper brush bears against the upper section and the lower brush against the lower section. The two brushes form the terminals of the machine. They should be connected to binding-posts.

In order to operate the dynamo properly and obtain sufficient current from it to operate a couple of small incandescent lamps, it will have to be provided with a pulley mounted on the end of the shaft after the gear wheel has been removed. The dynamo may then be driven at high speed by connecting it to a sewing-machine with a belt, or the back wheel of a bicycle from which the tire has been removed.

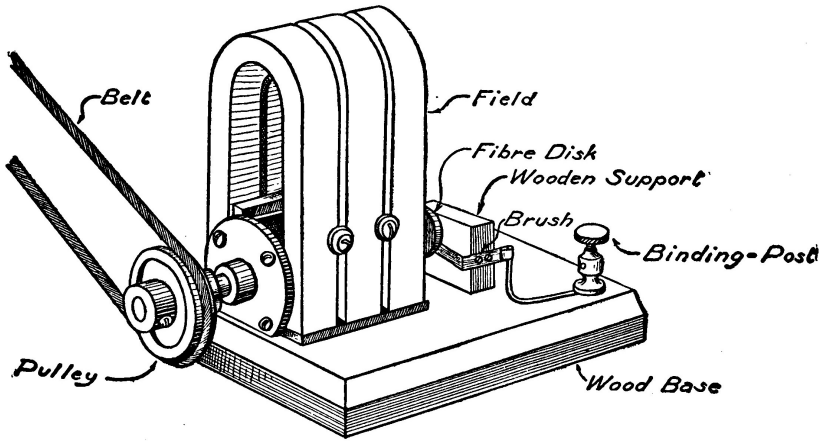

Fig. 254.—The Complete Generator.

The completed dynamo is shown in Figure 254. The voltage and amperage of the dynamo will depend upon the machine in question, not only upon the size of the wire but also upon the size of the machine, the speed at which it is run, and the strength of the horseshoe magnets. It is impossible to tell just what the current will be until it is tested and tried.

A 10-Watt Dynamo

Probably few experimenters fully understand how almost impossible it is to construct a dynamo, worthy of the name as such, without resort to materials and methods employed in the commercial manufacture of such machines. Practical telegraph instruments, telephones, etc., can be constructed out of all sorts of odds and ends, but in order to make a real dynamo it is necessary to use certain materials for which nothing can be substituted.

The field magnets must be soft gray cast-iron except in special instances.

The wire used throughout must be of good quality and must be new.

The necessity for good workmanship in even the smallest detail cannot be overestimated. Poor workmanship always results in inefficient working. No dynamo will give its stated output continuously and safely unless the materials and workmanship are up to a high standard.

Since castings must be used as field magnets, a pattern is necessary to form the mould for the casting. Pattern work is something requiring skill and knowl-

edge usually beyond the average experimenter. A lathe is necessary in order to bore or tunnel the space between the ends of the field magnet into which the armature fits.

It may be possible for several boys to club together and have a pattern made by a pattern-maker for building a dynamo. Then by using the lathe in some convenient shop or manual training school secure a field magnet and armature for a really practical small dynamo.

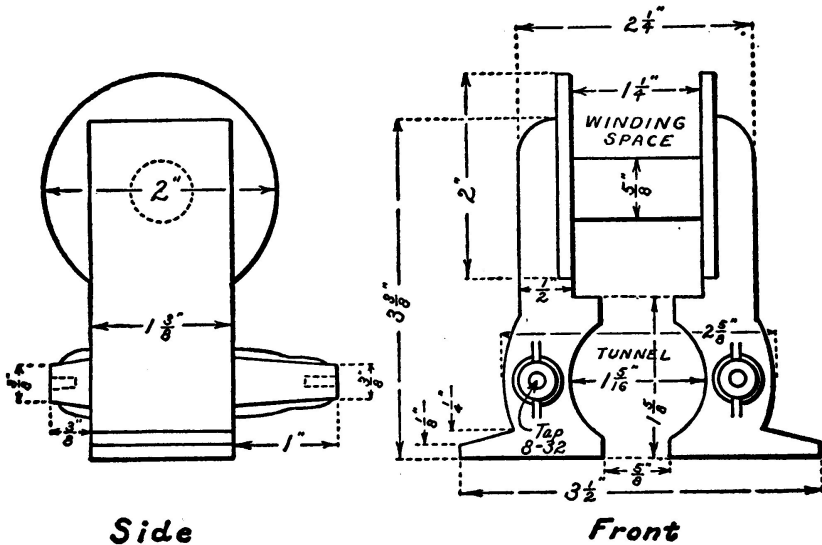

Fig. 255.—Details of the Field Casting.

For these reasons, I have described below a small dynamo of about ten watts output, the castings for which can be purchased from many electrical dealers with all machine work done at an extremely low price.

The field magnet shown in Figure 255 is drawn to scale and represents the best proportions for a small "overtyp" dynamo of ten to fifteen' watts output.

The dimensions are so clearly shown by the drawings that further comment in that respect is unnecessary.

The armature is of the type known as the "Siemen's H." It is the simplest type of armature it is possible to make, which is a feature of prime importance to the beginner at dynamo construction, although it is not the most efficient form from the electrical standpoint. The armature in this case is also a casting and

therefore a pattern is required.

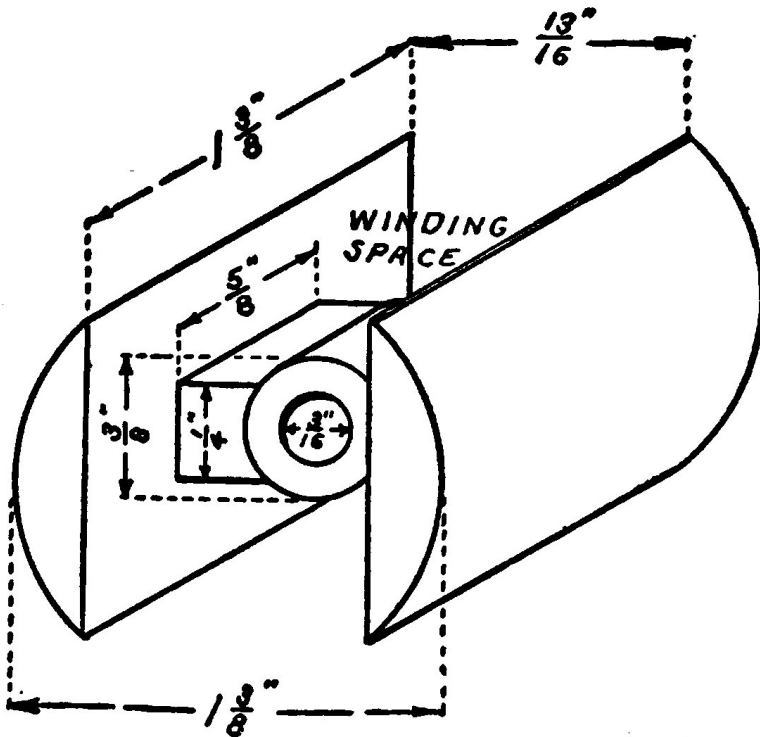

Fig. 256.—Details of the Armature Casting.

The patterns for both the field and the armature are of the same size and shape as shown in Figures 255 and 256. They are made of wood, and are finished by rubbing with fine sandpaper until perfectly smooth and then given a coat of shellac. The parts are also given a slight "draft," that is, a taper toward one side, so that the pattern may be withdrawn from the mould.

The patterns are turned over to a foundry, where they are carefully packed in a box, called a "flask," full of moulder's sand. When the patterns are properly withdrawn, they will leave a perfect impression of themselves behind in the sand. The mould is then closed up and poured full of molten iron. When the iron has cooled the castings are finished except for cleaning and boring.

The shaft is a piece of steel rod, three-sixteenths of an inch in diameter, and four and one-half inches in length.

The portion of the field into which the armature fits is bored out to a diameter of one and five-sixteenth inches. Considerable care is necessary in performing this operation in order not to break the field magnet apart by taking too heavy a cut.

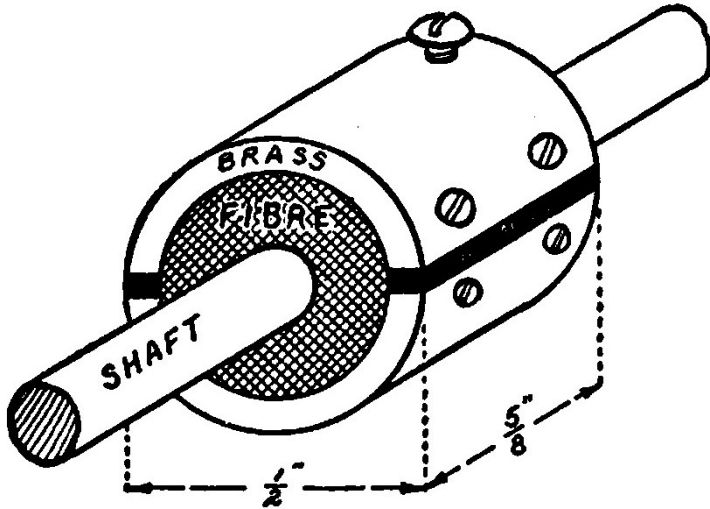

Fig. 257.—Details of the Commutator.

The armature should be turned down to a diameter of one and one-quarter inches or one-sixteenth of an inch smaller than the tunnel in which it revolves between the field magnets. The center of the armature is bored out to fit the shaft.

Figure 257 shows a two-part commutator for fitting to an armature of the "Siemen's H" type. It consists of a short piece of brass tubing fitted on a fiber core and split length-wise on two opposite sides, so that each part is insulated from the other.

The fiber is drilled with a hole to fit tightly on the shaft. It is then placed in a lathe and turned down until a suitable piece of brass tube can be driven on easily.

Two lines are then marked along the tube diametrically opposite. A short

distance away from each of these lines, and on each side of them, bore two small holes to receive very small wood screws. The screws should be counter-sunk. It is very important that none of the screws should go into the fiber core far enough to touch the shaft.

The commutator may then be split along each of the lines between the screws with a hacksaw. The saw-cut should be continued right through the brass and slightly into the insulating core. The space between the sections of the commutator should be fitted with well-fitting slips of fiber, glued in.

The commutator should now be trued up and made perfectly smooth.

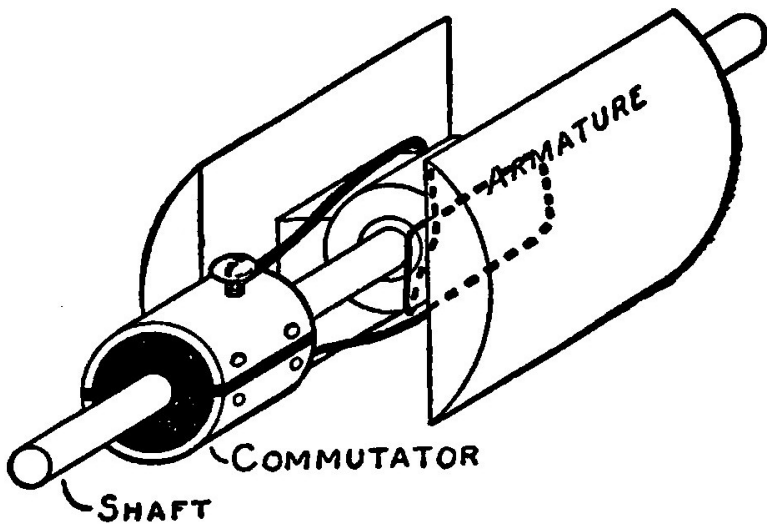

Fig. 258.—Diagram showing how to connect the Armature Winding to the Commutator.

The commutator is provided with a small brass machine screw threaded into each section near the edge as shown in Figure 257. These screws are to receive the ends of the armature winding and so facilitate connections.

The commutator, shaft and armature are assembled as shown in Figure 258.

The armature may be held to the shaft by a small set screw or a pin. The commutator should fit on the shaft very tightly so that it will not slip or twist.

Every part of the armature and shaft touched by the armature winding must be insulated with paper which has been soaked in shellac until soft. The armature

must be left to dry before winding.

The armature should next be wound with No. 20 B. & S. gauge single-cotton-covered magnet wire. Sufficient wire should be put on to fill up the winding space completely. Care should be taken, however, not to put on too much wire or it will interfere with the field magnets and the armature cannot revolve. After winding the armature, test it carefully to see that the wire is thoroughly insulated from the iron.

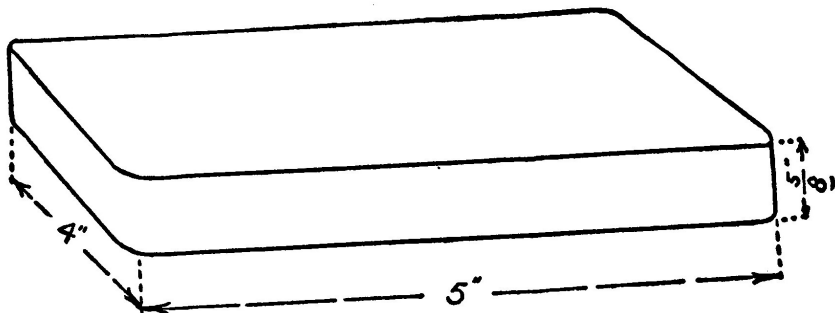

Fig. 259.—Details of the Wooden Base.

If the insulation is correct, paint the whole armature with thick shellac varnish and bake it in a warm oven to set the shellac.

Figure 258 is a diagram showing how the winding is made and connected. It is wound about the armature, always in the same direction, just as if the armature were an ordinary electro-magnet.

The ends of the winding are each connected to one of the commutator sections by scraping the wire and placing it under the screws.

The winding space in the field magnet should be shellacked, and insulated with brown paper by wrapping the core with a strip of paper and covering the bobbin ends with circular pieces made in two halves.

The field magnet is wound full of No. 20 B. & S. gauge single-cotton-covered wire. The wire should be put on in smooth, even layers and the winding space completely filled up.

The base for the dynamo is a piece of hard wood, five inches long, four inches wide, and five-eighths of an inch thick.

The bearings are small brass castings of the dimensions shown in Figure 260. It is necessary first to make a wooden pattern and send it to the foundry for the castings.

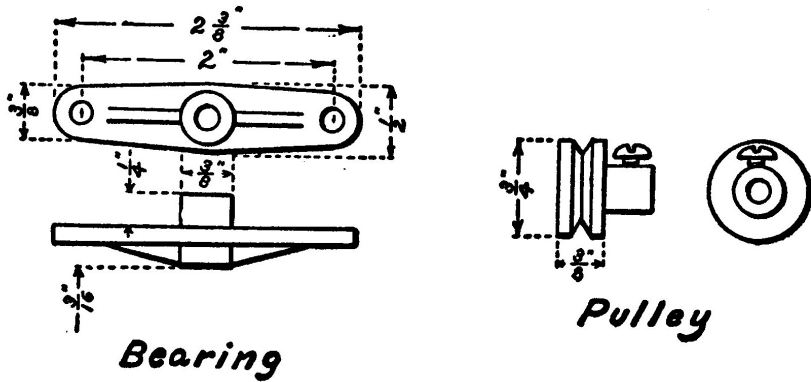

Fig. 260.—The Pulley and Bearings.

The bearings are fastened to the projecting arms on the field casting by means of machine screws eight-thirty-seconds of an inch in thickness.

The field magnet should not be screwed down on to the base until the armature runs easily and truly in the tunnel.

The brushes are made from thin gauge sheet-copper according to the shape and dimensions shown in Figure 261.

They are bent at right angles and mounted on the base on either side of the commutator with small round-headed wood screws.

The completed dynamo is shown in Figure 262. One end of the shaft is provided with a small pulley to accommodate a small leather belt.

The dynamo is connected as a "shunt" machine, that is, one terminal of the field magnet is connected to one of the brushes, and the other terminal to the other brush.

A wire is then led from each of the brushes to a binding-post.

A shunt dynamo will only generate when run in a certain direction. In order to make it generate when run in the opposite direction, it is necessary to reverse the field connections.

The dynamo just described should have an output of from 10 to 15 watts and deliver about 6 volts and $1\frac{3}{4}$ to $2\frac{1}{2}$ amperes.

In order to secure current from the dynamo it will first be necessary to magnetize the field by connecting it to several batteries.

It will be found that the dynamo will also operate as a very efficient little motor, but that on account of having a two-pole armature it must be started by

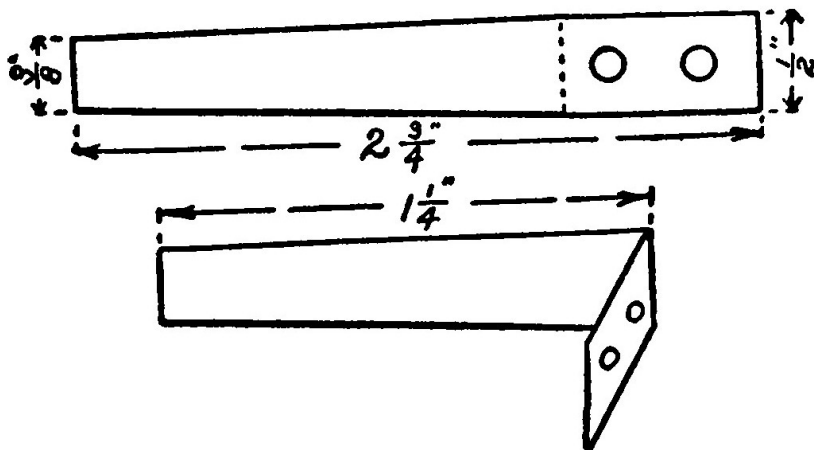

Fig. 261.—The Brushes.

giving the shaft a twist.

It can be used as a generator for lighting small lamps, electro-plating, etc., but cannot be used for recharging storage cells on account of having a two-pole armature.

The dynamo may be driven with a small water motor or from the driving-wheel of a sewing-machine.

Before the machine will generate as a dynamo, it must be connected to a battery and run as a motor. This will give the field the "residual magnetism" which is necessary before it can produce current itself.

CHAPTER XVIII AN ELECTRIC RAILWAY

No toys loom up before the mind of the average boy with more appeal to his love of adventure than do railway cars and trains. In England, the construction and operation of miniature railways is the hobby not only of boys but of grown men, and on a scale that is hardly appreciated in this country.

The height of ambition of many boys is not only to own a miniature railway system but to build one. For some unknown reason, none of the boys' papers or books have heretofore given any information on this interesting subject. The

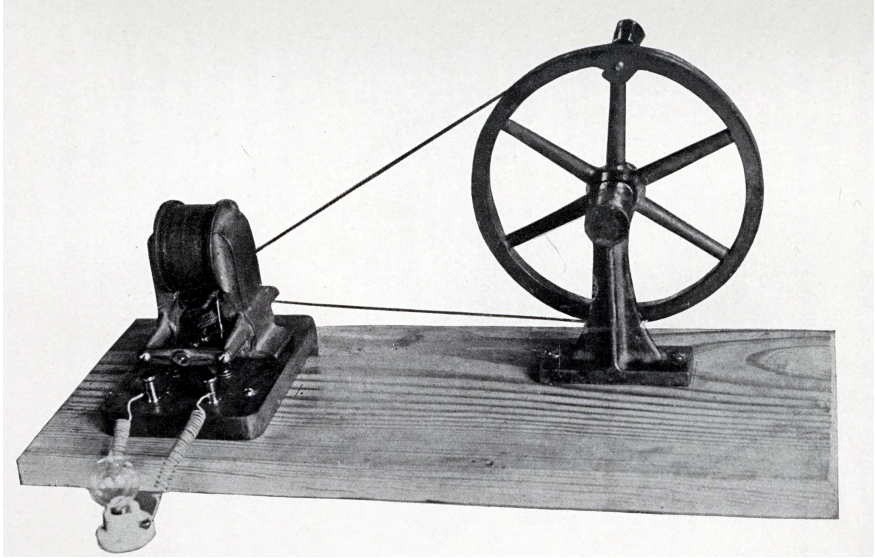

THE JUNIOR DYNAMO MOUNTED ON A LONG WOODEN BASE AND BELTED TO A GROOVED WHEEL FITTED WITH A CRANK SO THAT THE DYNAMO CAN BE RUN AT HIGH SPEED BY HAND POWER. THE ILLUSTRATION ALSO SHOWS A SMALL INCANDESCENT LAMP CONNECTED TO THE DYNAMO SO THAT WHEN THE CRANK IS TURNED THE LAMP WILL LIGHT.

car shown in Figure 263 is such that it can be easily built by any boy willing to exercise the necessary care and patience in its construction.

The first operation is to cut out the floor of the car. This is a rectangular piece of hard wood, eight inches long, three and one-quarter inches wide and one-half of an inch thick. Its exact shape and dimensions are shown in Figure 264.

The rectangular hole cut in the floor permits the belt which drives the wheels to pass down from the counter-shaft to the axle.

The two pieces forming the wheel-bearings are cut out of sheet-brass according to the shape and dimensions shown in Figure 265. The brass should be one-sixteenth of an inch thick. The two projecting pieces at the top are bent over at right angles so that they can be mounted on the under side of the car floor by small screws passing through the holes. The holes which form the bearings for the ends of the axles upon which the wheels are mounted should be three inches

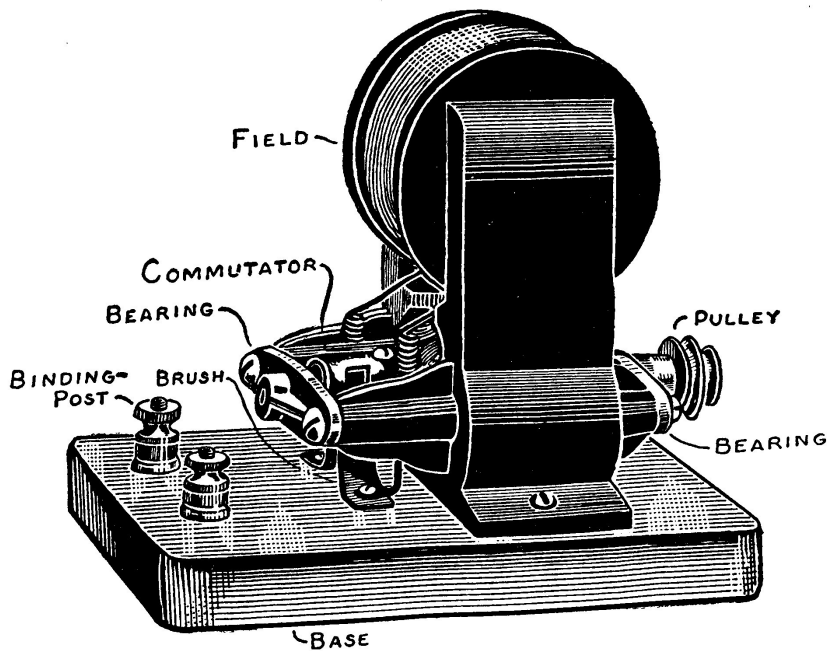
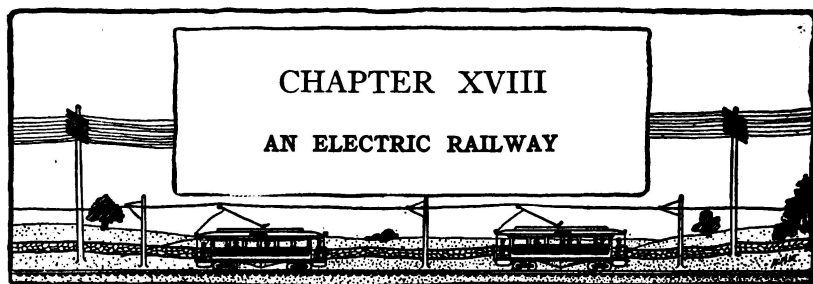

Fig. 262.—Complete Dynamo.



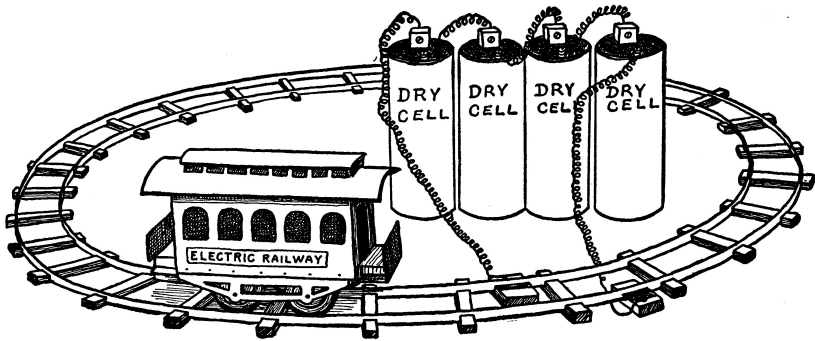

Fig. 263.—Complete Electric Railway operated by Dry Cells. Note how the Wires from the Battery are connected to the Rails by means of the Wooden Conductors illustrated in Figure 277.

apart. The bearings cannot be placed in position on the under side of the car floor until the wheels and axles are ready, but when this work is done, care should be taken to see that they line up and come exactly opposite to each other.

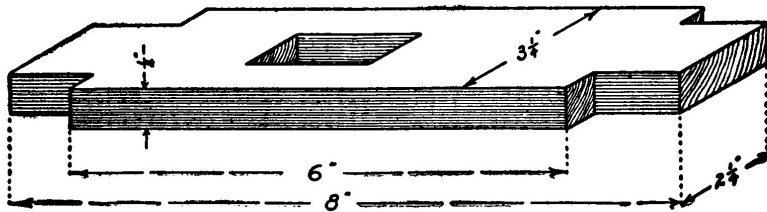

Fig. 264.—Details of the Floor of the Car.

The wheels themselves cannot be made by the young experimenter unless he has a lathe. They are flanged wheels, one and one-eighth inches in diameter, and are turned from cast iron or brass. Such wheels can be purchased ready made, or it may be possible to obtain from some broken toy a set which will prove suitable.

Each shaft is composed of two pieces of "Bessemer" rod held together by a short piece of fiber rod having a hole in each end into which one end of each

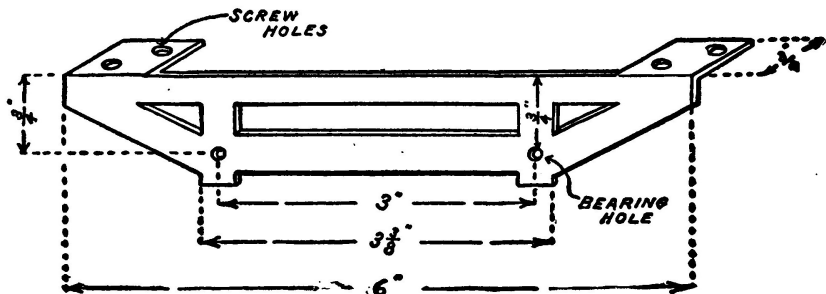

Fig. 265.—Details of the Bearing which supports the Wheel and Axle.

piece of iron rod is driven. The wheels fit tightly on the other end of each of these pieces. They should be spaced so as to run on rails two inches apart.

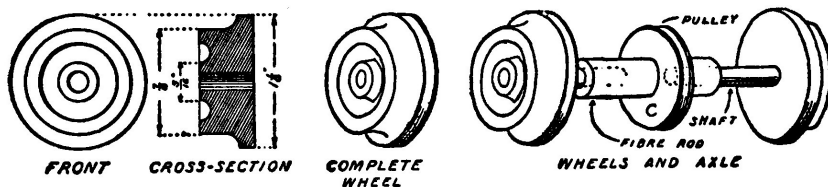

Fig. 266.—The Wheels and Axle.

The purpose of the fiber rod is to insulate the halves of the axle from each other. The electric current which operates the car is carried by the two rails which form the track, and if the axles were made in one piece or the halves joined together so as to form an electrical connection, the battery furnishing the current would be short-circuited, because the current would pass along the two rails and across the axles instead of through the motor.

One pair of wheels are fitted with a grooved pulley one inch in diameter.

It is hardly necessary to say that the wheels and axles should be perfectly aligned, and should run true.

The motor used to drive the car will prove more satisfactory if purchased ready made. A self-starting three-pole motor similar to that shown in Figure 267 will serve very nicely. The wooden base should be removed and the motor

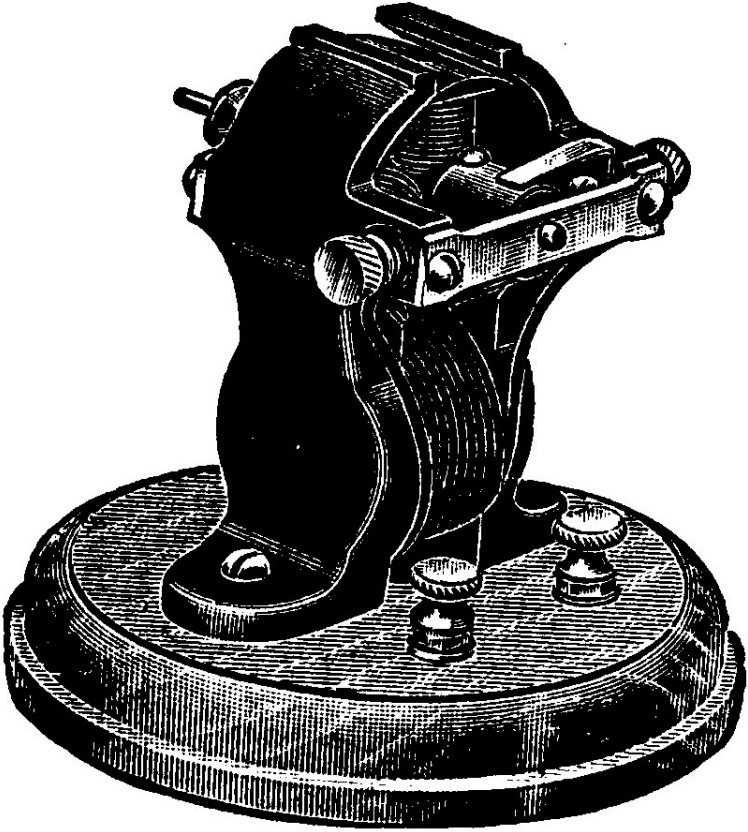

Fig. 267.—The Motor.

screwed down firmly to the floor of the car as in Figure 268.

One terminal of the motor is connected to one of the bearings, and the other terminal to the other bearing.

The motor is belted to a countershaft so that it will have sufficient power to move the car. It cannot be directly connected or belted to the axle, because the speed of a small motor is so high that it has comparatively little turning power or *torque*. The speed must be reduced and the torque increased before it will drive the car.

The countershaft consists of two grooved pulleys mounted upon an axle running in two bearings mounted upon the floor of the car. The bearings are made from a strip of heavy sheet-brass, bent at right angles and fastened to the car floor with small screws. The large pulley, *A*, is one inch and one half in diameter and the small pulley, *B*, is five-sixteenths of an inch in diameter. The countershaft is mounted in such a position that a belt may be run from the small pulley, *B*, to the pulley mounted on the axle of one pair of wheels. A belt is also run from the small pulley on the motor to the large pulley, *A*, on the countershaft. The pulleys must all be carefully lined up so that the belts will run in their grooves without danger of slipping out.

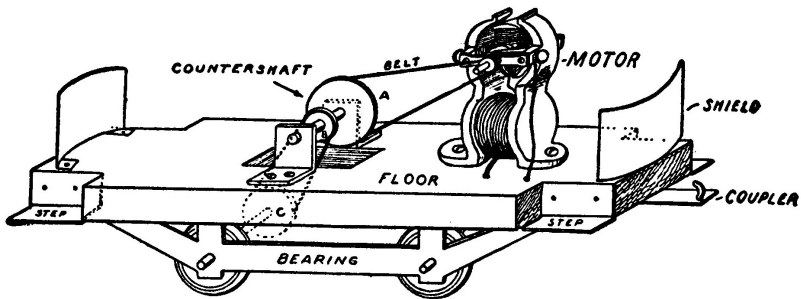

Fig. 268.—The Complete Truck of the Car without the Body.

The shield on the platform at each end of the car is made of sheet-iron or tin. Two small projections on the bottom are bent over at right angles and used to secure the shields in position by driving a small tack through them into the floor of the car.

The steps on either side of each platform are also made by bending strips of sheet-iron or tin and fastening them to the car with small nails or tacks.

The coupler consists of a strip of tin having a small hook soldered to the

end so that a trail car may be attached if desirable.

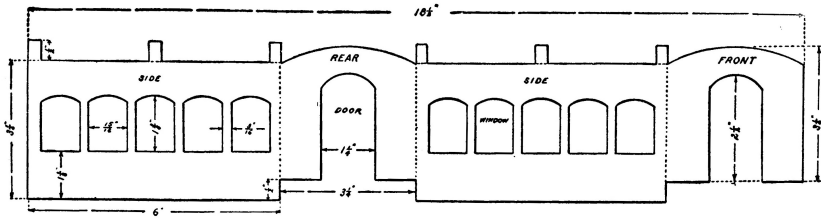

Fig. 269.—Pattern for the Sides and Ends of the Car.

The car is now ready for testing, and when held in the hand so that the wheels are free to run, two cells of dry battery should be found all that is necessary to drive them at a fair rate of speed. The two wires leading from the battery should be connected to the bearings, one wire leading to each bearing. It will require more than two cells, however, to drive the wheels properly when the car is on the track. All moving parts should run freely and smoothly. The car may be used just as it is, but if fitted with a body and a top it will present a much more realistic appearance.

The sides and ends of the car body are made of sheet-iron or tin. Figure 269 shows the pattern and dimensions for these parts. They may be made from one piece of metal eighteen and one-half inches long and three and three-quarters inches wide. The doors and windows are cut out with a pair of tin-snips. The small projections along the top are bent down at right angles and the roof is fastened to them. The dotted lines indicate the places for bending these projections and also the sides and ends of the car.

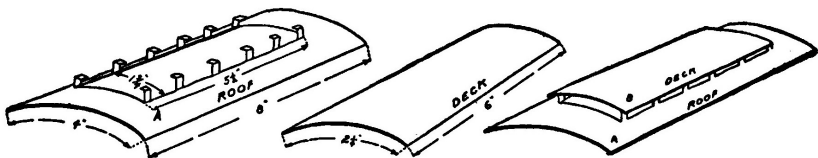

Fig. 270.—The Roof of the Car.

The roof is made in two pieces. It also is sheet-iron or tin. The roof proper

is eight inches long and four inches wide. It has a hole five and one-half inches long and one and three-quarters inches wide cut in the center. A number of small projections are left and bent upward to support the deck and to form imitation ventilators. The deck is six inches long and two and one-quarter inches in width. It is placed in position on the roof and fastened by soldering. The roof is fastened to the sides and ends of the car by soldering. It must be bent slightly to conform with the curve at the top of the front and the rear of the car.

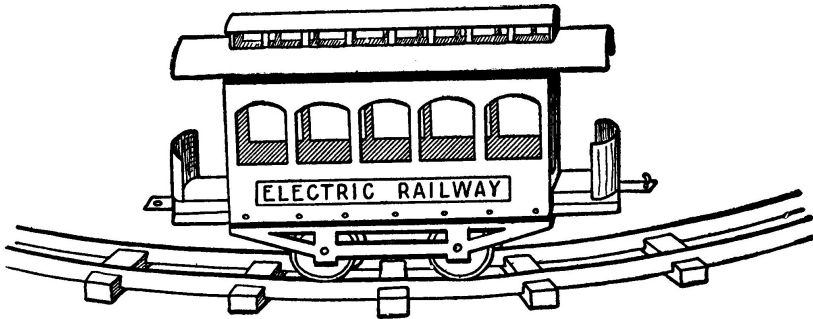

Fig. 271.—The Completed Car.

The car when completed will appear as in Figure 271.

The track is made of smooth spring steel, one-half inch wide and either No. 20 or No. 22 gauge in thickness.

The wooden ties are three and one-half inches long, three-quarters of an inch wide and three-eighths of an inch thick. Each tie has two saw-cuts, exactly two inches apart across the top face. This part of the work is best performed in a miter-box so that the cuts will be perfectly square across the ties. A saw should be used which will make a cut of such a size that the steel track will fit tightly into it.

The distance between the two rails of the track, or the "gauge," as it is called, is two inches.

The track is assembled as in Figure 273. The spring steel is forced into the saw-cuts in the ties by tapping with a light wooden mallet. The ties should be spaced along the track about three inches apart. The work of laying the track must be very carefully done so that the car wheels will not bind at any spot. Curves should not be too sharp, or the car will not pass around.

The track may be laid out in a number of different shapes, some of which

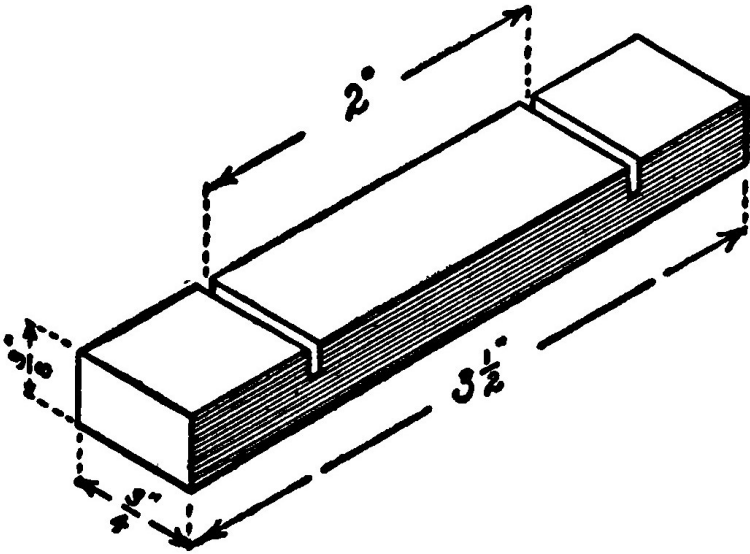

Fig. 272.—Details of a Wooden Tie.

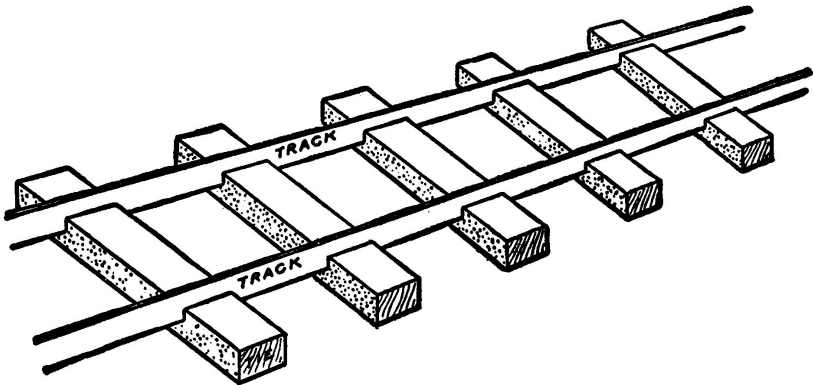

Fig. 273.—Arrangement of Track.

are shown in Figure 274.

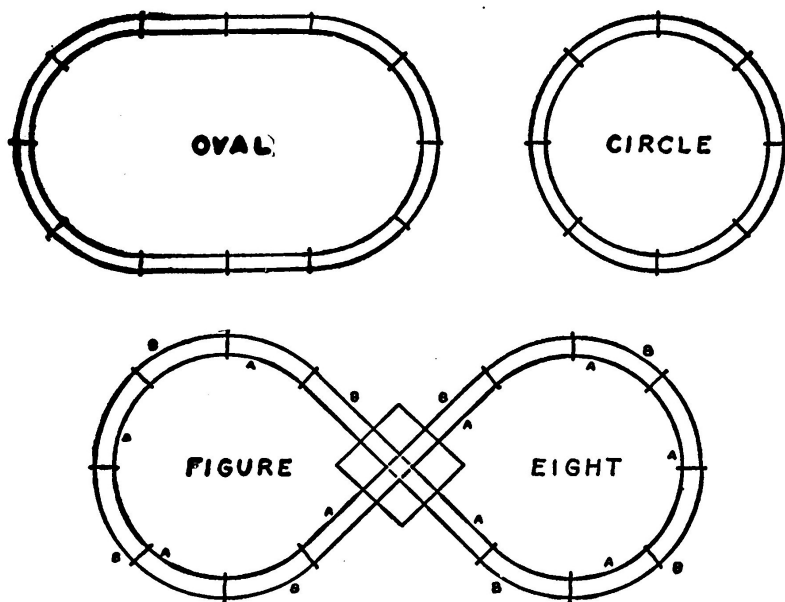

Fig. 274.—Three Different Patterns for laying out the Track.

A circle is the easiest form of track to make. In laying out a circle or any sort of curved track, the outside rail must necessarily be made longer than the inside one.

The oval shape is a very good form to give the track in a great many cases, especially where it is desirable for the car to have a longer path than that afforded by a circle.

In order to make a figure-eight out of the track, a crossing, or "cross-over," as it is sometimes called, will be required. This is shown in Figure 275. A cross-over permits two tracks to cross each other without interference. It consists of a wooden base, eight inches square and three-eighths of an inch thick. Four saw-cuts, each pair exactly parallel, and two inches apart, are made at right angles to each other across the top surface of the base, as shown in the illustration.

The track used on the cross-over is semi-hard hoop-brass, one-half of an inch wide and of the same gauge as the steel track. The brass is more easily bent than the steel and is used for that reason, it being practically impossible to bend

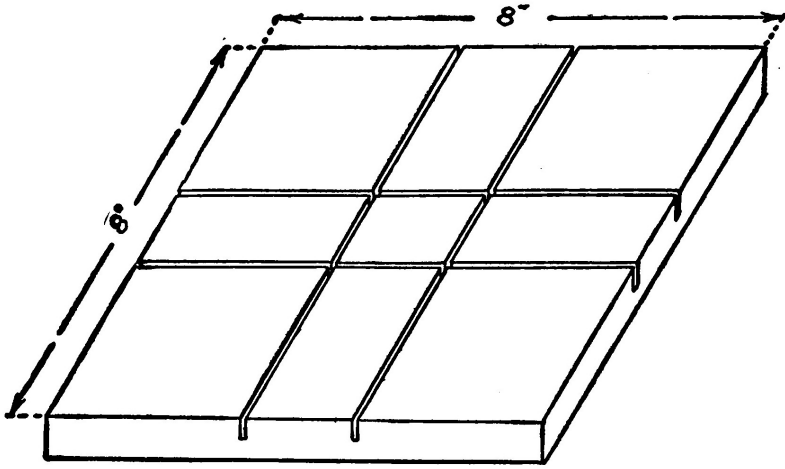

Fig. 275.—Details of the Base of the Cross-over.

the steel track at right angles without snapping it.

Four pieces of the brass, each five inches long, are bent at right angles exactly in the center. Four short pieces, each one and one-half inches long, will also be required.

The cross-over is assembled as shown in Figure 276. The strips marked *D* are strips of very thin sheet-brass or copper. The purpose of these strips is to connect the ends of the track on the cross-over to the ends of the track forming the figure-eight so that the cross-over will not be a "dead" section, that is, a section of track where the car cannot get any current.

The long strips, bent at right angles to each other and marked *A, A, B, B*, in the illustration, are forced into the saw-cuts in the base over the strips marked *D*.

The small pieces, *C, C, C, C*, are placed in between the long strips, leaving a space between so that the flanges of the car wheels can pass. The pieces, *C, C, C, C*, should form a square open at the corners. The two long strips, *A, A*, should be at opposite corners diagonally across the square. *B* and *B* should occupy the same relative position at the other corners. *A* and *A* are connected together and *B* and *B* are connected together by wires passing on the under side of the base.

The ends of the track forming the figure-eight are forced into the saw-cuts at the edges of the base so that they form a good electrical connection with the

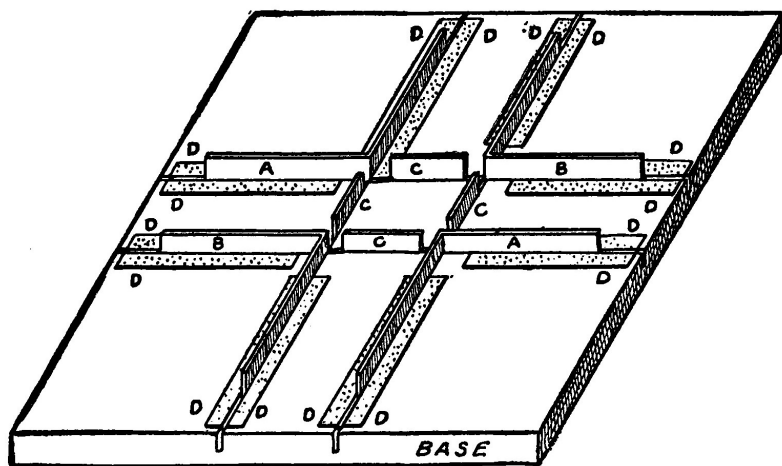

Fig. 276.—The Completed Cross-over.

small strips marked *D*.

It is quite necessary to use care in arranging a figure-eight track, or there will be danger of short-circuiting the batteries. The outside rails of the figure-eight, distinguished by the letter *B* in the illustration, should be connected together by the cross-over. The inside rails, marked *A*, should also be connected together by the cross-over.

In order to make a good mechanical and electrical connection between the ends of the rails when two or more sections of track are used in laying out the system, it is necessary to either solder the rails together or else use a connector such as that shown in Figure 277.

This consists of a small block of wood having a saw-cut across its upper face and a piece of thin sheet-brass set into the cut. The two rails are placed with their ends abutting and one of these connectors slipped up from beneath and forced on the rails. The piece of thin brass set into the wooden block serves to make an electrical connection between the two rails and also to hold them firmly in position. A small screw and a washer placed outside the track and passing through the brass strip will allow a battery wire to be conveniently attached.

The steel rails should be occasionally wiped with machine oil or vaseline to prevent rusting, and also to allow the car to run more freely wherever the flanges of the wheels rub against the rails in passing around a curve.

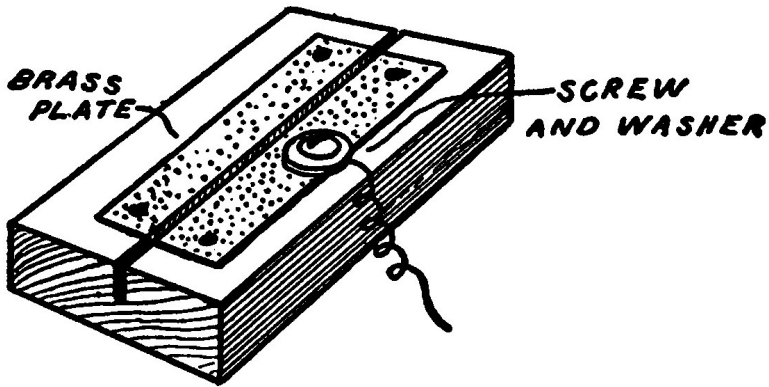

Fig. 277.—A Connector for joining the Ends of the Rails.

Four dry cells or three cells of storage battery should be sufficient to operate the car properly. If it is desirable, a small rheostat may be included in the battery circuit, so that the speed of the car can be varied at will. The motor and the wheels should be carefully oiled so that they will run without friction. The belts should not be so tight that they cause friction or so loose that they allow the motor to slip, but should be so adjusted that the motor runs freely and transmits its power to the wheels.

The car may be made reversible by fitting with a small current reverser, but unless the reverser is carefully made the danger of loss of power through poor contacts is quite considerable. If the car is fitted with a reverser the handle should be arranged to project from the car in a convenient place where it can be easily reached by the fingers and the car sent back or forth at will.

A railway system such as this can be elaborated and extended by adding more than one car to the line or such features as bridges and stations.

The ends of a blind section of track, that is, a straight piece of track not part of a circle or curve so that the car can return, should be fitted with a track bumper, to prevent the car leaving the rails.

No dimensions are given in Figures 279 and 280, showing designs for a bridge and a station, because they are best left to be determined by the scale upon which the railway system is to be extended.

Both the bridge and the station are very simple. The bridge is built entirely of wood, with the exception of the steel rails.

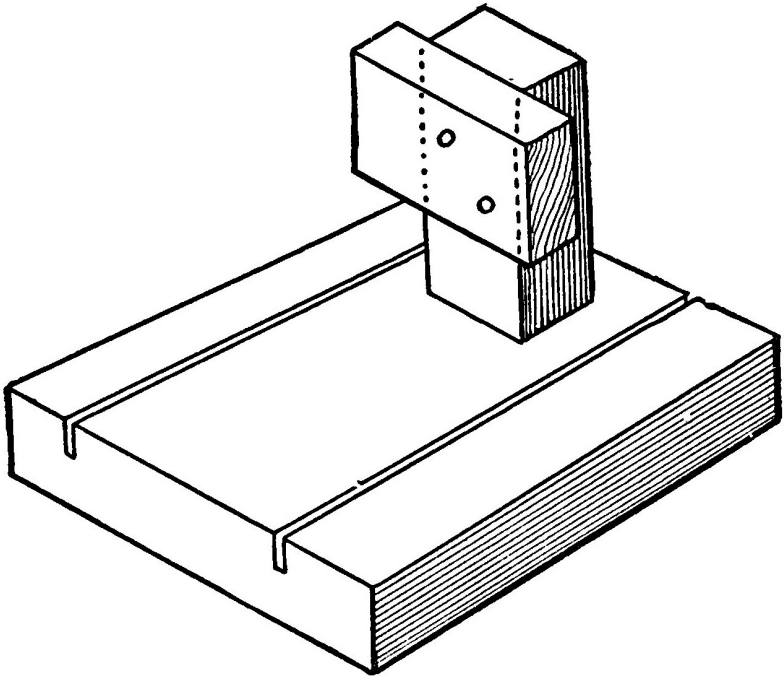

Fig. 278.—A Bumper for preventing the Car from leaving the Rails.

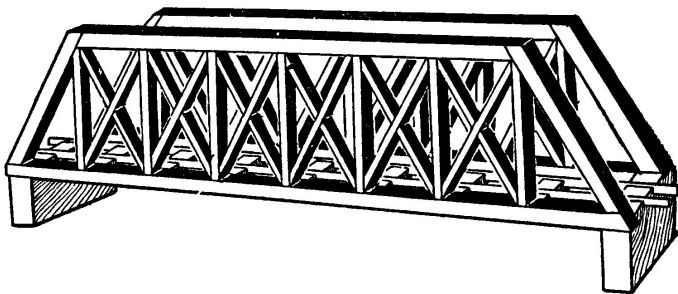

Fig. 279.—A Design for a Railway Bridge.

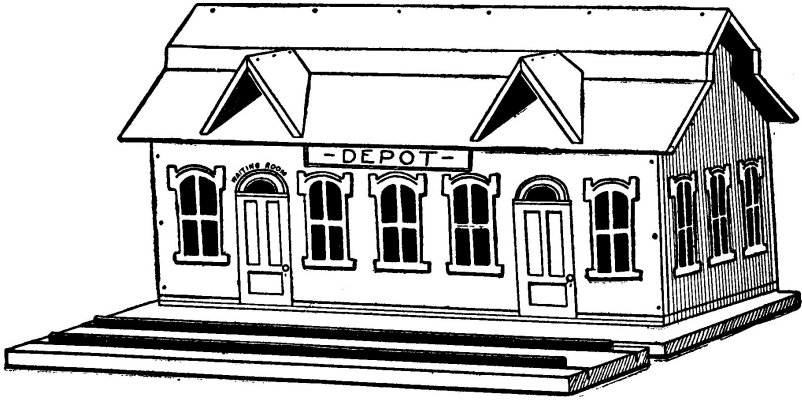
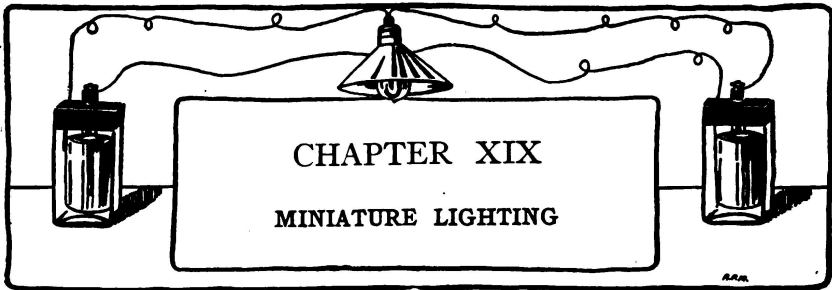

Fig. 280.—A Design for a Railway Station.

The station may be made out of thin wood, such as cigar-box wood. The doors, windows, etc., may be painted on the walls. If this is carefully done, it will give a very realistic appearance to your station.



CHAPTER XIX MINIATURE LIGHTING

Miniature lighting is a field of many interesting possibilities for the young experimenter. Any labor expended along this line will result in something far more useful from a practical standpoint than almost any of the other things described in this book.

Miniature lights, operated from batteries, may be used in various ways; to light dark corners, hallways, or other places where a light is often temporarily wanted without the accompanying danger and nuisance of matches or kerosene lamps.

Miniature lighting has only been made practical by the tungsten filament lamp. The filament, or wire inside the globe, which becomes hot and emits the light when the current is turned on, is made of *tungsten* in a tungsten lamp. In the earlier lamps, it was made of carbon. The carbon lamp is now seldom used and is highly inefficient when compared to the tungsten.

A Carbon Lamp consumes about three and one-half watts of current for each candle-power of light, whereas a small tungsten lamp uses only about one watt per candle-power. The tungsten lamp is therefore three times as efficient as a carbon lamp, and when used on a battery of equal voltage it is possible to obtain the same amount of light with one-third of the current that would be required by a carbon lamp.

Carbon lamps similar to that shown in Figure 281 are made in a number of different voltages. The lowest voltage that it is practically possible to make a carbon lamp for is three and one-half. A three-and-one-half volt carbon lamp is designed to be operated on small dry cells such as flashlight batteries. The E. M. F. of a dry cell is about one and one-half volts, but when three small dry cells of the flashlight type are connected in series and used to operate a lamp, their voltage "drops," and the available E. M. F. is only about three and one-half volts.

Four-volt carbon lamps are intended to be operated on large dry batteries or wet cells because they do not lose their voltage as quickly as small dry cells. The table below gives the voltage and candle-power of the various small carbon lamps which are carried in stock by most electrical dealers or supply houses:

MINIATURE CARBON BATTERY LAMPS

3.5 volts for flashlight batteries

4 volts. 2 candle-power

5.5 volts for flashlight batteries

6 volts. 2 candle-power

6 volts. 4 candle-power

8 volts. 4 candle-power

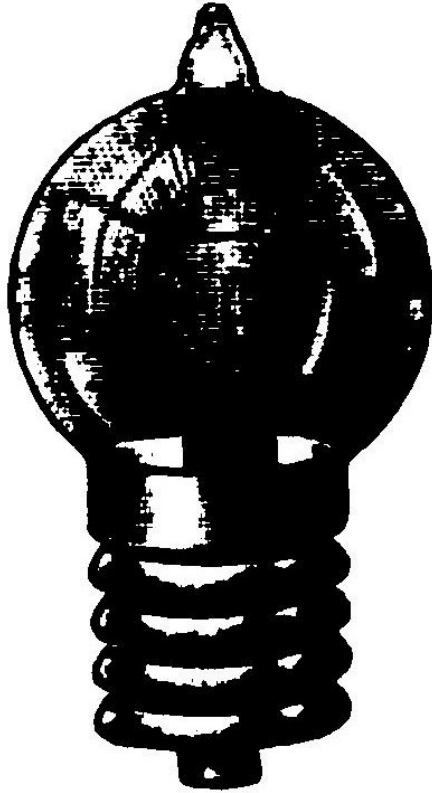

Fig. 281.—Miniature Carbon Battery Lamp.

10 volts. 6 candle-power

Tungsten Lamps are made for voltages as low as one and one-half, and will light on one cell of dry battery. The range of voltages is quite wide and varied. A few of the most common sizes are given below:

MINIATURE TUNGSTEN BATTERY LAMPS

1.5 volts. for one dry cell

2.5 volts. for two-cell flashlight battery

2.8 volts. for two-cell flashlight battery

3.5 volts. for three-cell flashlight battery

3.8 volts. for three-cell flashlight battery

4 volts. 4 candle-power

6 volts. 2 candle-power

6 volts. 4 candle-power

6 volts. 6 candle-power

6 volts. 8-10-12-16-20-24 candle-power

To find the approximate amount of current drawn from a battery by a tungsten lamp, divide the candle-power by the voltage and the result will be the current in amperes. For example, a 6 v. 2 c. p. lamp will require, 2 divided by 6, or one-third of an ampere.

Six-volt tungsten lamp giving a light greater than six candle-power are only used on storage batteries and are employed principally for automobile lighting.

The filament of a tungsten lamp is much longer than that of a carbon lamp and is usually in the form of a spiral or helix, as shown in Figure 282.

The bases of battery lamps, the base being the lower portion of the lamp, which is made of brass and fits into a socket or receptacle, are made in three different styles: *miniature*, *candelabra*, and *Ediswan*.

The miniature and candelabra bases have a threaded brass shell on the outside and a small brass contact-button on the bottom. They are similar except in

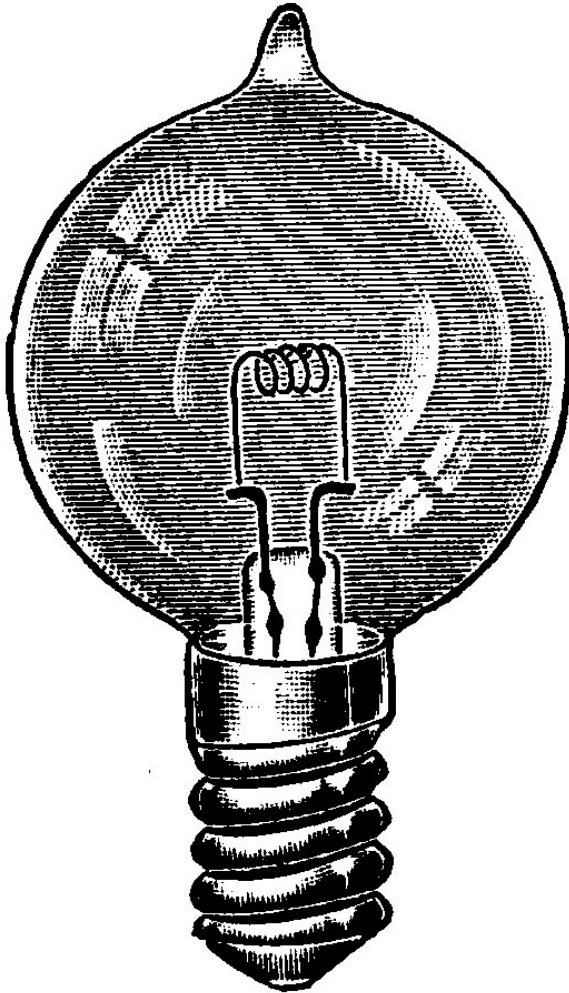

Fig. 282.—Miniature Tungsten Battery Lamp.

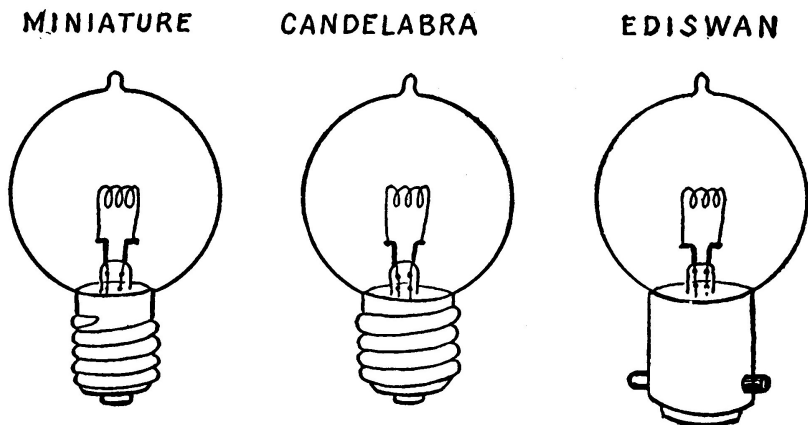

Fig. 283.—Lamps fitted respectively with Miniature, Candelabra, and Ediswan Bases.

respect to size. The miniature base is smaller than the candelabra. The Ediswan base is a plain brass shell having two pins on the side and two contacts on the bottom. This type of base is only used in this country on automobiles. The miniature and the candelabra bases are standard for battery lighting. The miniature base has many advantages over the candelabra for the young experimenter, and should be adopted in making any of the apparatus described in this chapter. These three bases are shown in Figure 283.

In order to form a good electrical connection between the lamp and the power wires some sort of a receptacle or socket is necessary. The most common arrangement for this purpose is the miniature flat-base porcelain receptacle shown in Figure 284. This type of receptacle is used in places where it can be permanently fastened in position with two small screws.

The devices shown in Figure 285 are known respectively as a porcelain weather-proof socket and a pin-socket. Sockets similar to the weather-proof socket are also made of wood. The weather-proof sockets are used in places where the light is to be exposed out-of-doors, as for instance on a porch. The small metal parts are sealed in the porcelain and entirely protected.

The pin-sockets and the wooden sockets are used principally on Christmas trees or in decorative outfits where lamps are hung in festoons. The flat-base receptacle, the pin-socket, and also the wooden socket will be found very useful in making the apparatus described farther on in this chapter.

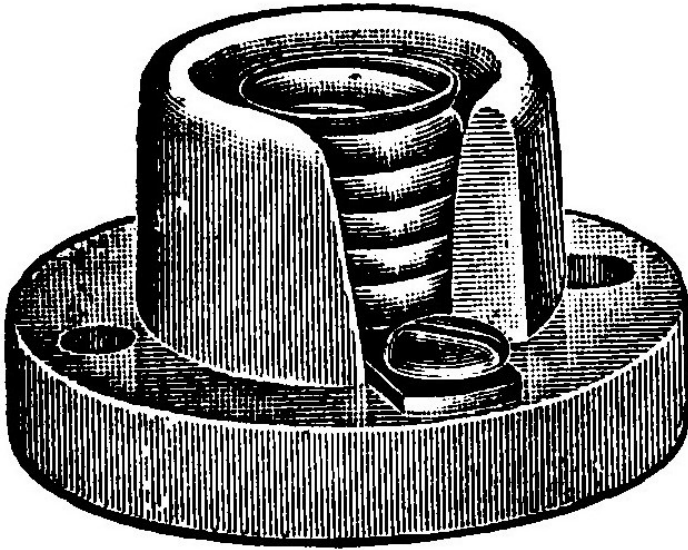

Fig. 284.—Miniature Flat-Base Porcelain Receptacle.

The Wires used to carry the current in a miniature lighting system may be of the sort known as *annunciator* or *office* wire if the wires are to be run entirely indoors. The wire should not be smaller than No. 16 B. & S. gauge. When the wires are run outdoors, on a porch, or in some other place exposed to the weather, the wire used should be rubber-covered. Hanging lights or lights intended to be adjustable should be connected with "flexible conductor." This is made of a number of very fine wires braided together and insulated with silk. The wires used in a lighting system should not in any case be longer than it is necessary to have them. When a battery is connected to a system of wires it is found that the voltage at the end of the wires is much lower than at a point near the battery. This is called voltage "drop," and is much greater as the wires grow longer. A light placed at the end of two very long wires will not burn as brightly as it would if connected to the same battery by means of short wires.

Switches can be made by following the suggestions given in Chapter VII. Suitable switches can be purchased for a few cents at a most any electrical house and will prove very much neater and efficient. They should preferably be of any

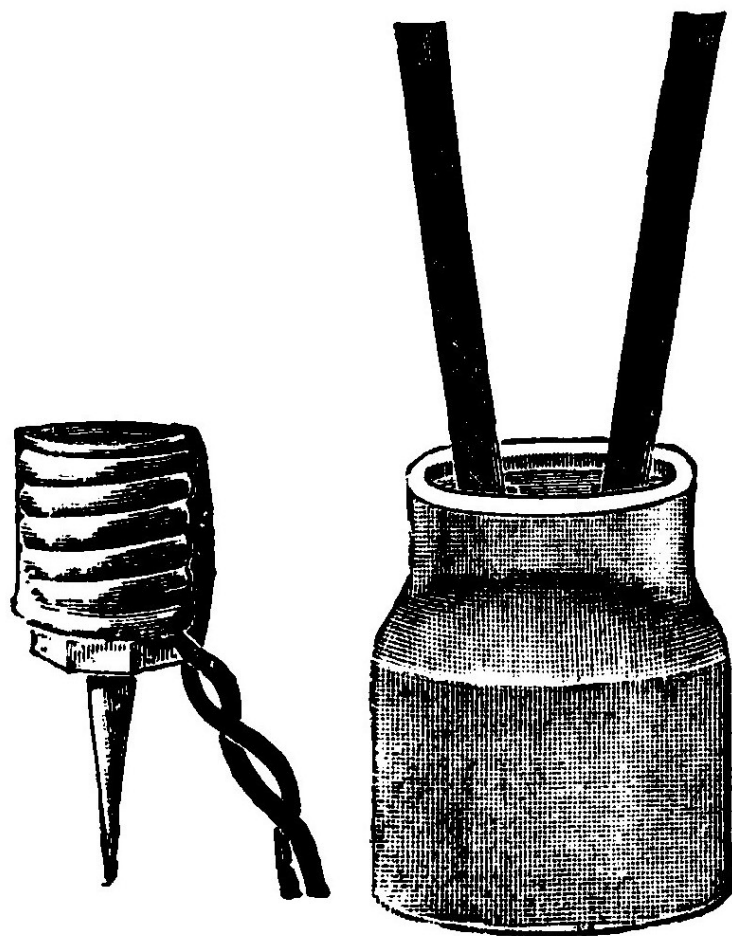

Fig. 285.—Weather-proof and Pin-Sockets.

of the types shown in Figure 286.

The Batteries used for miniature lighting may be made up of storage cells, dry cells or carbon cylinder cells. Storage cells will prove the most satisfactory, provided that the experimenter has some convenient means of recharging them or of having them recharged. Storage cells will be found of especial value wherever it is desirable to operate several lights from one battery.

Carbon cylinder cells are only suitable where one cell is to be operated at a time. If more than one is used, the battery is liable to become polarized and the lamps will not burn brightly. Carbon cylinder batteries are very inexpensive to renew, and will be found the cheapest method of lighting a small tungsten lamp.

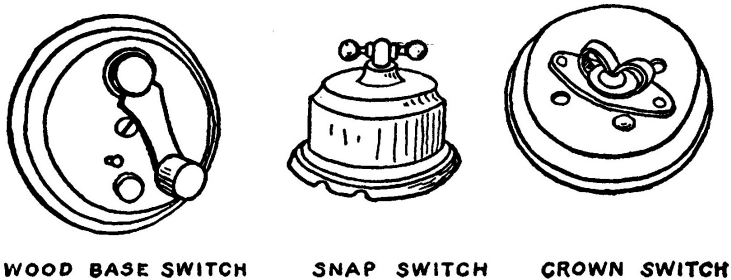

Fig. 286.—Types of Battery Switches suitable for Miniature Lighting.

If lamps requiring more than two amperes are to be operated on dry cells, the latter should be connected in series-multiple, as shown in Figure 69. Two sets of dry cells connected in series-multiple will give more than twice the service of a single set.

Lamps may be connected either in multiple or in series, provided that the proper voltages of both battery and lamps are used.

When they are to be connected in multiple, the voltage of the lamps should be the same as that of the battery. When they are to be used in series, the voltage of the lamps multiplied by the number used should equal the voltage of the battery. For example, suppose that you wish to use a number of six-volt lamps on a six-volt storage battery. In that case they must be connected in multiple. But if it should be that the lamps are only two-volt lamps and you wish to operate three of them on a six-volt battery you will have to place them in series.

It is sometimes desirable to arrange a lamp and two switches so that it can be turned off or on from either switch independently of the other. This is called "three-way wiring," and is a very convenient method of arranging a light in a

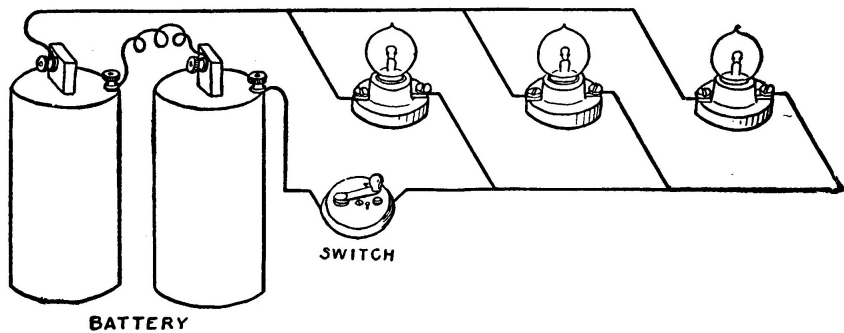

Fig. 287.—How Lamps are Connected in Multiple.

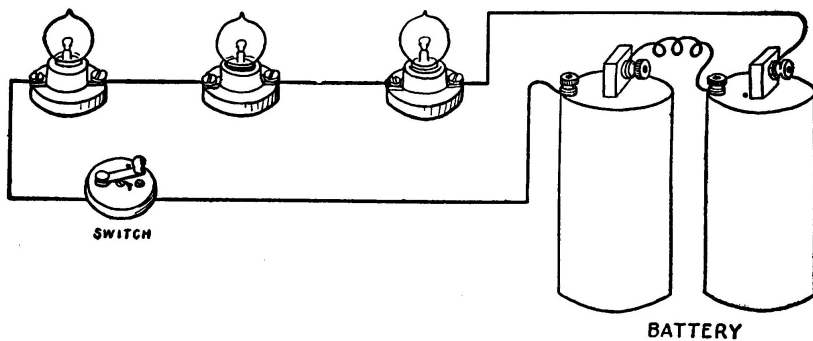

Fig. 288.—How Lamps are Connected in Series.

hallway. If one switch is placed at the top of a stairway and the other switch at the bottom, a person can pass upstairs or downstairs, light the lamp ahead, and turn it out as he passes the last switch, no matter in which direction the previous user of the light may have gone.

The switches are two-point switches, and the circuit should be arranged as in Figure 289.

The switch-levers should always rest on one of the contacts and never be left between, as shown in the drawing.

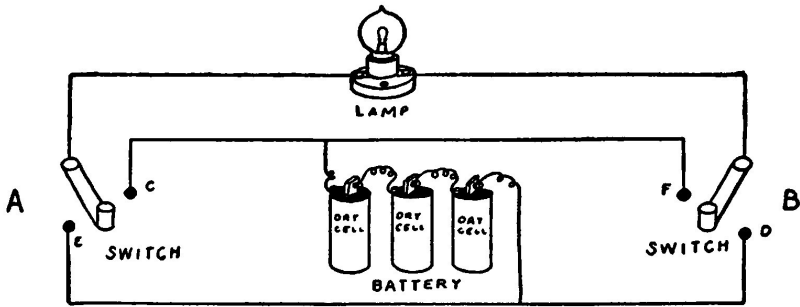

Fig. 289.—Three-way Wiring Diagram. The Light may be turned off or on from either Switch.

They are represented that way in the illustration in order not to conceal the contacts.

Small brackets made of brass and similar to that shown in Figure 290 are for sale at many electrical supply houses, and will add a very realistic appearance to a miniature lighting plant.

Brackets may be constructed after the plan shown in Figure 291. A wooden socket or a pin-socket is mounted on the end of a small piece of brass tubing which has been bent into the shape shown in the illustration. The other end of the tube is set into a wooden block so that the bracket may be mounted on the wall. The wires from the socket lead through the brass tube and through the back or top of the block.

Hanging lights may be arranged by fitting a wooden socket and a lamp with a reflector as shown in Figure 296. The reflector consists of a circular piece of tin or sheet-aluminum having a hole in the center large enough to pass the base of a miniature lamp. The circle is then cut along a straight line from the circumference to the center. If the edges are pulled together and lapped the circular sheet of

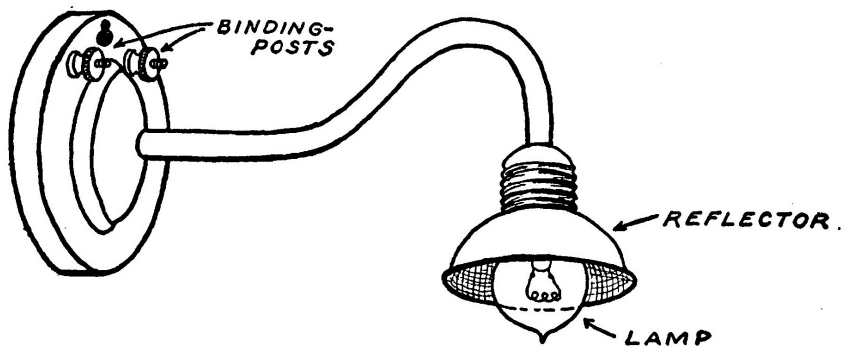

Fig. 290.—A Lamp Bracket for Miniature Lighting.

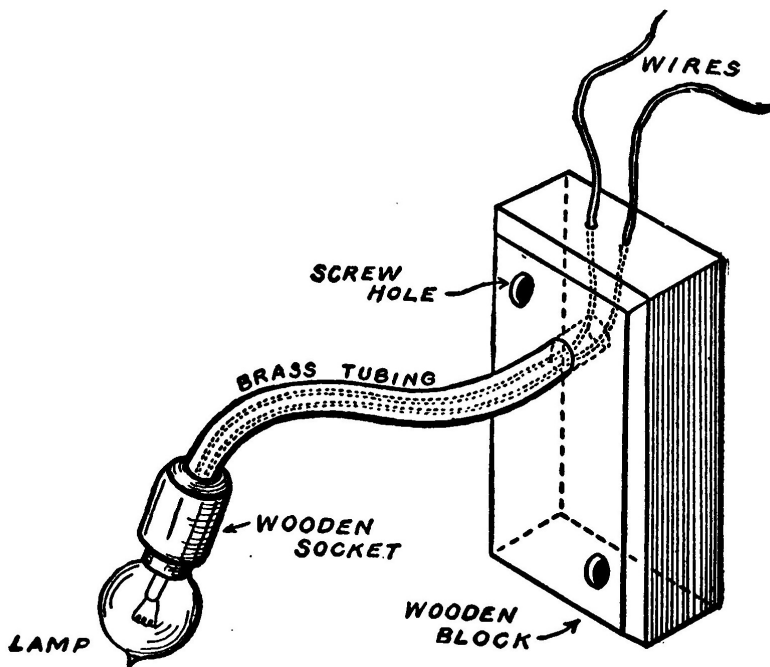

Fig. 291.—A Home-made Bracket.

metal will take on a concave shape and form a shade or reflector which will throw the light downwards. The overlapping edges of the reflector should be soldered or riveted together. The reflector is slipped over the base of the lamp, a small rubber or felt washer having been placed over the base next to the glass bulb so that the reflector will not break the lamp. The lamp is then screwed into a socket and allowed to hang downwards from a flexible conductor.

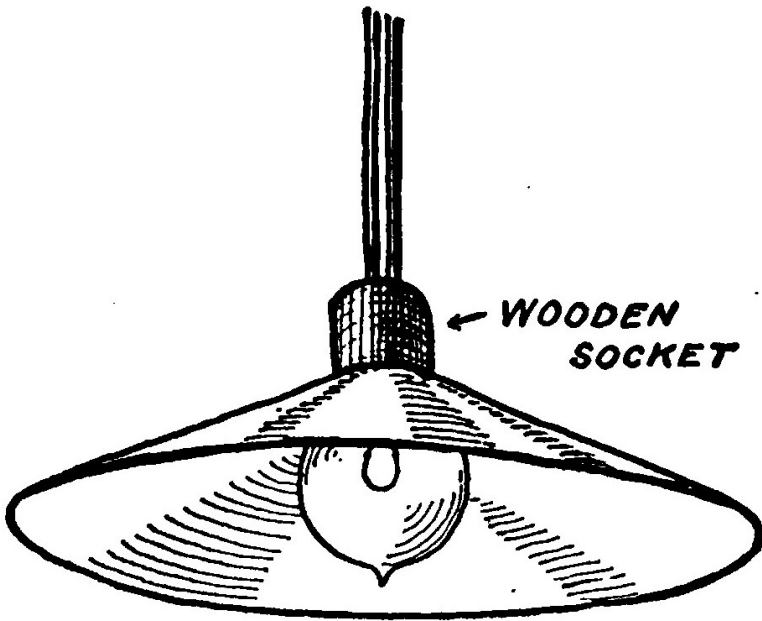

Fig. 292.—A Hanging Lamp.

A very pretty effect can be secured by drilling the edges of a reflector full of small holes about three-sixteenths of an inch apart and then hanging short strings of beads from the holes. The beads should form a hanging fringe around the edge of the reflector, and if they are of glass, a pleasing brilliancy is produced. Figure 293 shows how to make the reflector.

The batteries for a miniature lighting plant may be located in a closet, under a stairway, or in some other out-of-the-way place. Wires from there may be

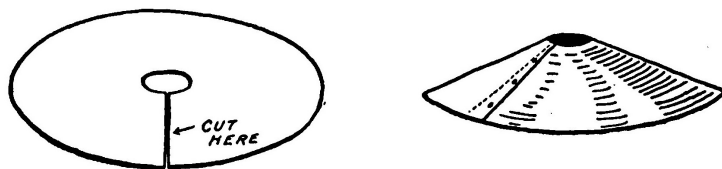

Fig. 293.—How the Reflector is made.

extended to various parts of the house, such as hallways, closets, the cellar stairs, over a shaving-mirror in the bath-room or in any dark corner where a light is often temporarily needed. The wires can be run behind picture-mouldings or along the surbase and be almost entirely concealed.

Small Batteries consisting of three small dry cells enclosed in cardboard box, as shown in Figure 294, are on the market, and may be bought at prices ranging from thirty to forty cents, depending upon the size and the maker. One of the most convenient and practical sizes of this type of battery has the dimensions shown in the illustration, and with its aid it is possible to construct a number of very useful electrical novelties and household articles in the shape of portable electric lamps, etc. These batteries are quite small and are only intended to operate very small lamps. Only one lamp should be used on each battery at a time, and it should not be allowed to burn long. Some of these batteries will give ten to fourteen hours of intermittent service but if allowed to burn continuously would only light the lamp for about five hours at the most. It is much the better plan to use them only for a few minutes at a time, and then turn the light off and allow the battery to recuperate.

An Electric Hand-Lantern is a very convenient device which is quite simple to make. It consists of a wooden box large enough to receive a three-cell battery, such as that shown in Figure 295. The back of the box should open and close on hinges and be fastened with a hook so that the battery may be easily removed for renewal.

A three-and-one-half-volt tungsten lamp is mounted on the front of the lantern and connected with the battery and a switch so that the light can be turned on and off at will. The switch may be placed at the top of the box so that the fingers of the same hand used to carry the lantern may be used to turn the light on and off. The lantern is fitted with a leather strap at the top, to be convenient for carrying.

The Ruby Lantern shown in Figure 296 is somewhat similar in arrangement

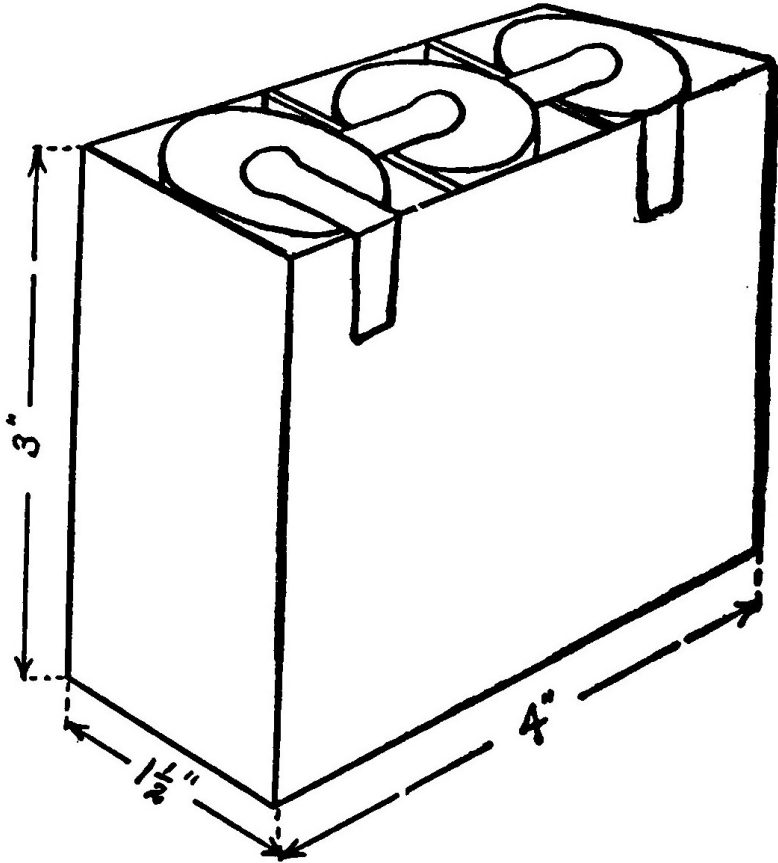

Fig. 294.—A Three-Cell Dry Battery for use in Hand-Lanterns, etc.

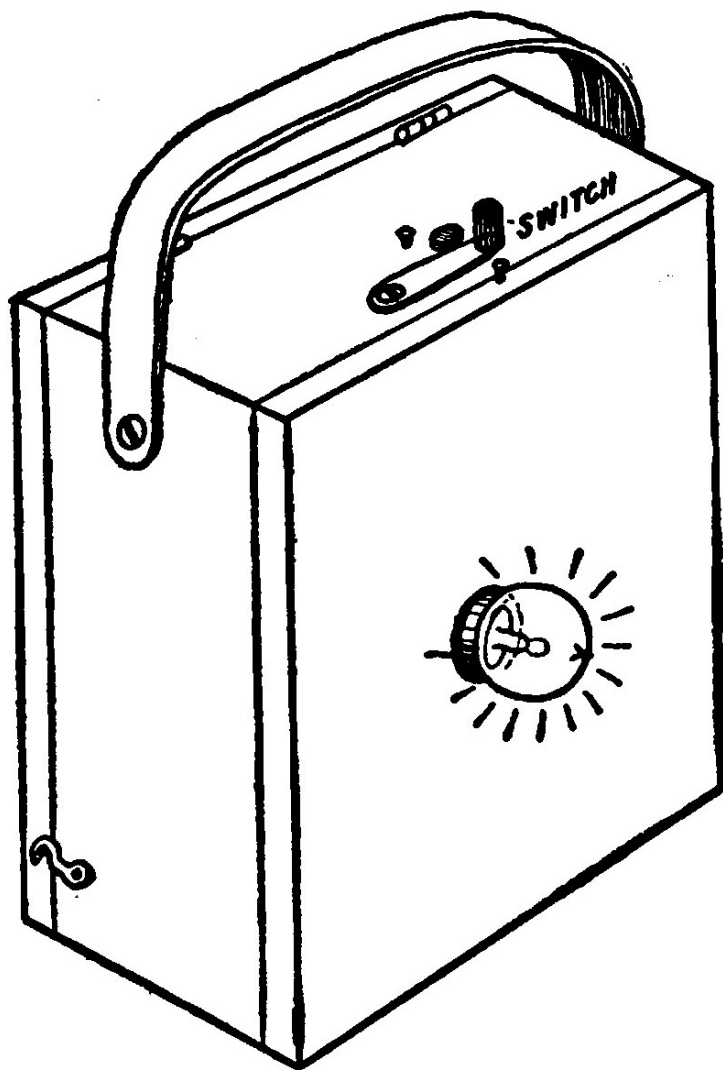

Fig. 295.—An Electric Hand-Lantern.

to the lantern just described, which may be used both as a hand-lantern and a ruby light for developing photographs.

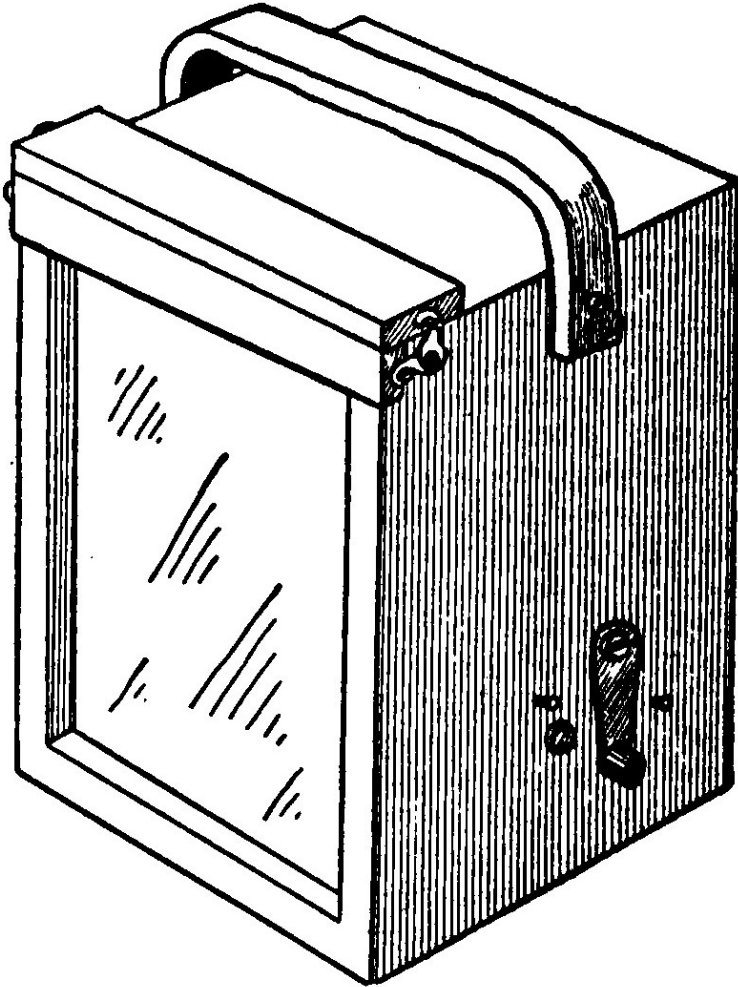

Fig. 296.—An Electric Ruby Lantern.

It consists of a wooden box to hold a three-cell dry battery, and is provided with a handle so that it may be easily carried. A switch by which to turn the lamp on and off is mounted on the side of the box.

The light is furnished by a three-and-one-half-volt tungsten lamp mounted on the front of an inclined wooden board arranged as shown in the illustration so as to throw the light downward. The sides and bottom of the box are grooved near the front edges so that a piece of ruby glass may be inserted. Ruby glass for this purpose may be purchased at almost any store dealing in photographers' supplies.

The top is provided with a shield which is fastened in position by means of four small hooks after the glass is in place. The shield is used in order to prevent any white light from escaping through the crack between the glass and the top of the box. A ruby lamp of this sort must be made absolutely "light-tight" so that the only light emitted is that which passes through the ruby glass. If any white light escapes it is liable to fog and spoil any pictures in process of development.

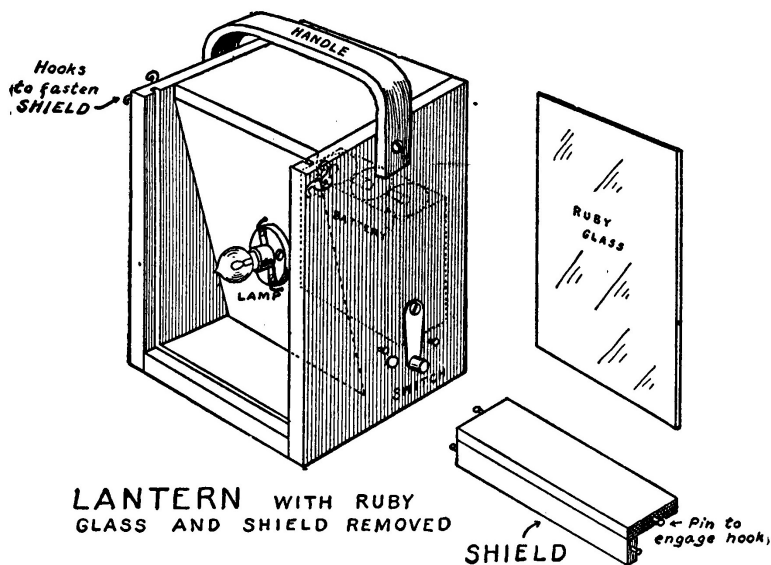

Fig. 297.—The Electric Ruby Lamp with Glass and Shield Removed.

By removing the ruby glass and the shield, as shown in Figure 297, the light is changed into a hand-lantern. The back of the box should be made removable

so that the battery can be replaced when worn out.

A **Night-Light** arranged to shine on the face of the clock so that the time may be easily told during the night without inconvenience is shown in Figure 298.

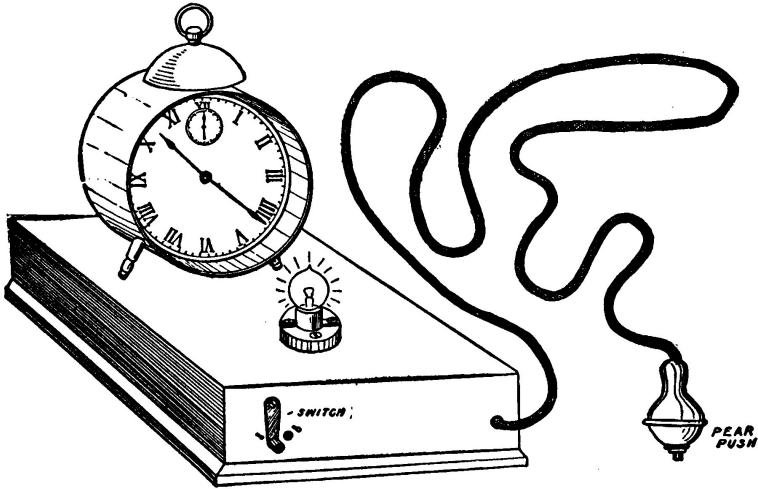

Fig. 298.—An Electric Night-Light for telling the Time during the Night.

It consists of a flat wooden box containing a three-cell dry battery and having a small three-and-one-half-volt tungsten lamp mounted on the top in the front with room for a clock to stand behind. The battery and the lamp are connected to a switch so that the light may be turned on and off. By attaching a long flexible wire and a push-button of the "pear-push" type it is possible to place the light on a table and run the wire with the push-button attached over to the bed so that one may see the time during the night without getting up. The bottom of the box should be made removable so that a new battery may be inserted when the old one is worn out.

The **Watch-Light** is in many ways similar to the clock light just described—but is smaller. It consists of a box just large enough to receive a three-cell flashlight battery. A piece of brass rod is bent into the form of a hook or crane from which to suspend the watch.

The light is supplied by a three-and-one-half-volt tungsten flashlight bulb mounted on the top of the box in front of the watch. If desirable, the light may be fitted with a small shade or reflector so that it shines only on the dial and not

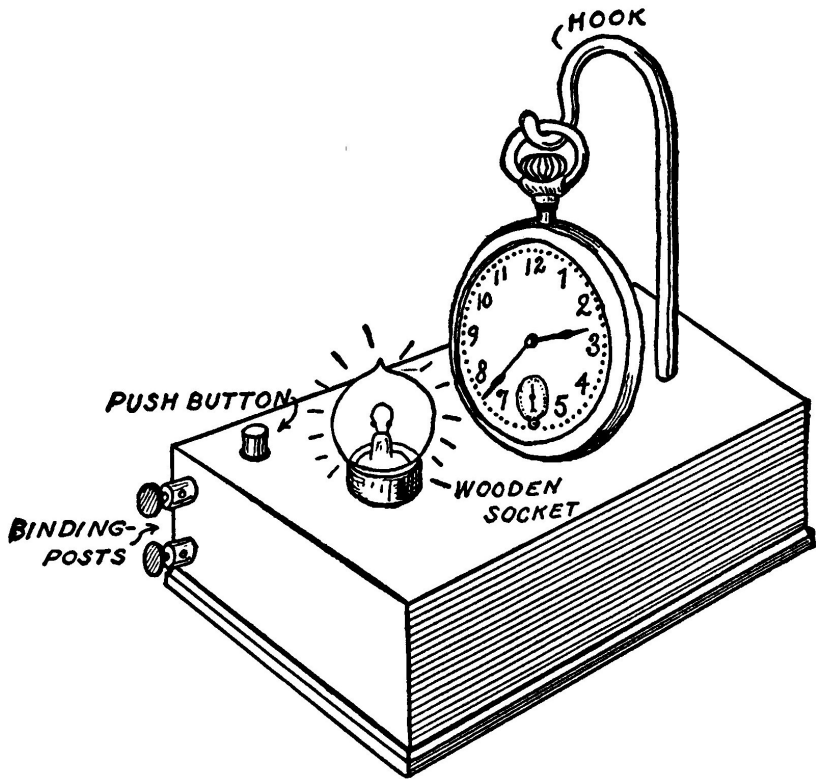

Fig. 299.—A Watch-Light.

in the eyes. The figures on the face of the timepiece can then be seen much more plainly.

The lamp is mounted in a small wooden socket or a pin-socket passing through a hole in the top of the box, so that the wires are concealed. A small push-button is located in one of the forward corners of the box, so that when it is pressed the lamp will light. Two small binding-posts mounted at the lower right-hand corner of the box are connected directly across the terminals of the switch, so that a flexible wire and a push-button can be connected, and the light operated from a distance.

An **Electric Scarf-Pin** can be made by almost any boy who is skillful with a pocket-knife. The material from which the pin is made may be a piece of bone, ivory, or meerschaum. It is carved into shape with the sharp point of a penknife and may be made to represent a skull, dog's head, an owl, or some other simple figure. The inside is hollowed out to receive a "pea" lamp. Pea lamps with a cord and a plug attached as shown in Figure 300 may be purchased from almost any electrical supply house. The lamp is a miniature carbon bulb about one-eighth of an inch in diameter. The eyes, nose, and mouth of the figure are pierced with small holes, so that when the lamp is lighted the light will show through the holes. The figure should be carved down thin enough to be translucent and light up nicely.

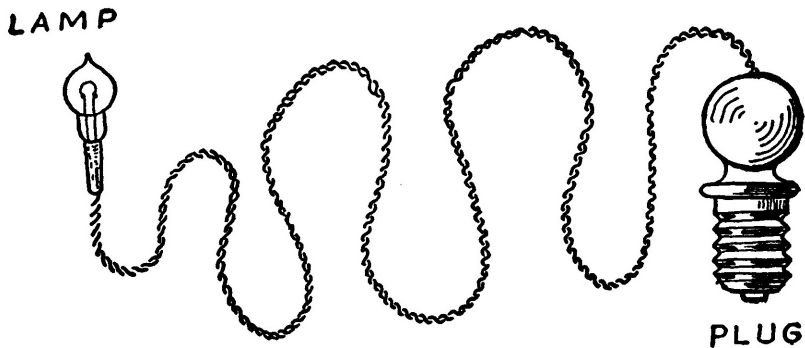

Fig. 300.—A "Pea" Lamp attached to a Flexible Wire and a Plug.

A large pin is cemented or otherwise fastened to the back of the figure so that it can be placed on the necktie or the lapel of the coat. The lamp is removed from the socket of an electric flashlight and the plug attached to the pea lamp

screwed into its place. The pea lamp is inserted inside the figure and bound in place with some silk thread. Then when the button is pressed on the flashlight case, the pin will light up and tiny beams of light will shoot out from the eyes, nose, and mouth of the figure.

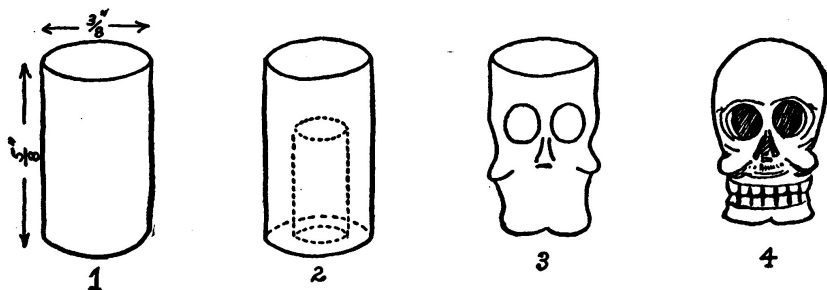

Fig. 301.—Four Steps in Carving a Skull Scarf-Pin. 1. The Bone. 2. Hole drilled in Base. 3. Roughed out. 4. Finished.

The drawings in Figure 301 show how to carve a skull scarf-pin. It is made from a cylindrical piece of bone about five-eighths of an inch long and three-eighths of an inch in diameter. The first operation is to drill a hole three-eighths of an inch deep into the bottom. The hole should be large enough in diameter to pass the pea lamp.

Then carve the eyes and nose and teeth. The drawings will give a good idea of the steps in this part of the work. Next round off the top of the skull. Bore a small hole in the back to receive the pin. Put the light inside of the skull, and after it is bound in position the scarf-pin is finished.

CHAPTER XX MISCELLANEOUS ELECTRICAL APPARATUS

HOW ELECTRICITY MAY BE GENERATED FROM HEAT

For the past century there has been on the part of many scientists and inventors a constant endeavor to "harness the sunlight." The power which streams down every day to our planet is incalculable. The energy consumed in the sun and thrown off in the form of heat is so great that it makes any earthly thing seem infinitesimal. We can only feel the heat from a large fire a few feet away, yet the

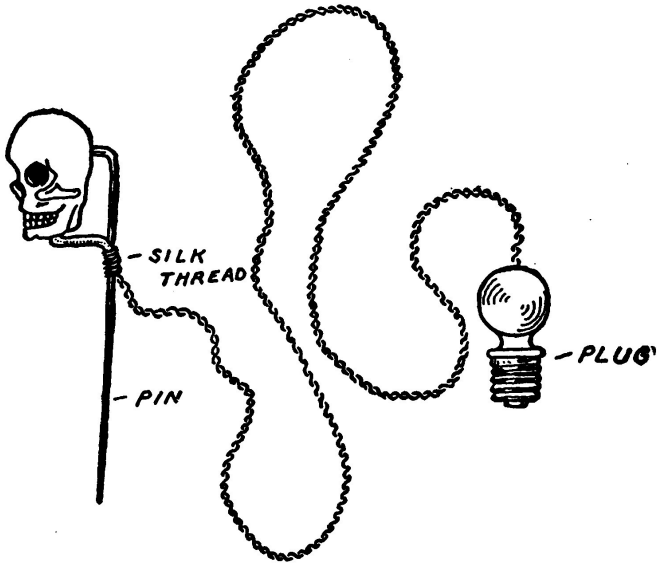
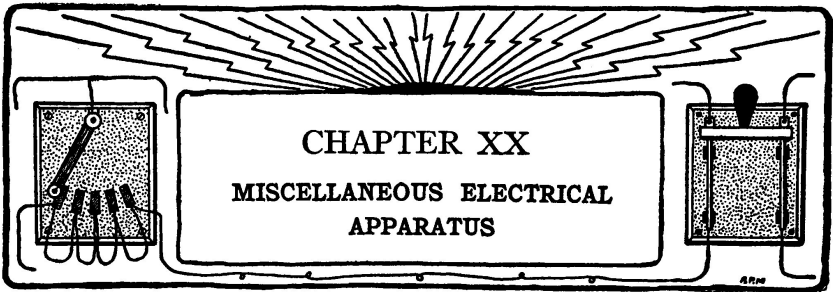

Fig. 302.—The Completed Pin ready to be connected to a Battery by removing the Lamp from a Flashlight and screwing the Plug into its Place.



scorching summer heat travels 90,000,000 miles before it reaches us, and even then our planet is receiving only the smallest fractional part of the total amount radiated.

Dr. Langley of the Smithsonian Institute estimated that all the coal in the State of Pennsylvania would be used by the sun in a fraction of a second if it were sent up there to supply energy.

Perhaps, some day in the future, electric locomotives will haul their steel cars swiftly from city to city by means of electricity, generated with "sun power." Perhaps energy from the same source will heat our dwellings and furnish us light and power.

This is not an idle dream, but may some day be an actuality. It has already been carried out to some extent. A Massachusetts inventor has succeeded in making a device for generating electricity from sun energy.

The apparatus consists of a large frame, in appearance very much like a window. The glass panes are made of violet glass, behind which are many hundred little metallic plugs. The sun's heat, imprisoned by the violet glass, acts on the plugs to produce electricity. One of these generators exposed to the sun for ten hours will charge a storage battery and produce enough current to run 30 large tungsten lamps for three days.

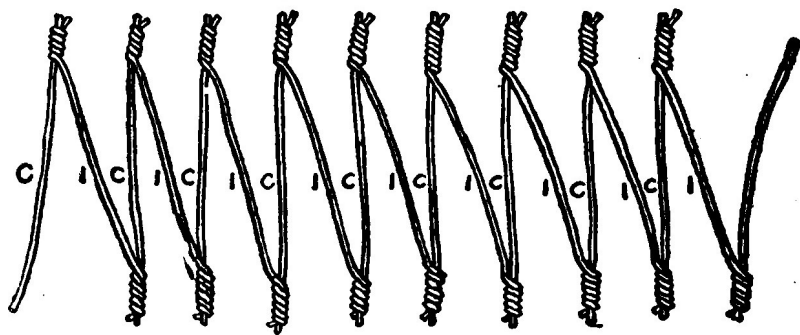

Fig. 303.—How the Copper Wires (C) and the Silver Wires (I) are twisted together in Pairs.

The principle upon which the apparatus works was discovered by a scientist named Seebeck, in 1822. He succeeded in producing a current of electricity by heating the points of contact between two dissimilar metals.

Any boy can make a similar apparatus, which, while not giving enough

current for any practical purpose, will serve as an exceedingly interesting and instructive experiment.

Cut forty or fifty pieces of No. 16 B. & S. gauge German silver wire into five-inch pieces. Cut an equal number of similar pieces of copper wire, and twist each German silver wire firmly together with one of copper so as to form a zig-zag arrangement as in Figure 303.

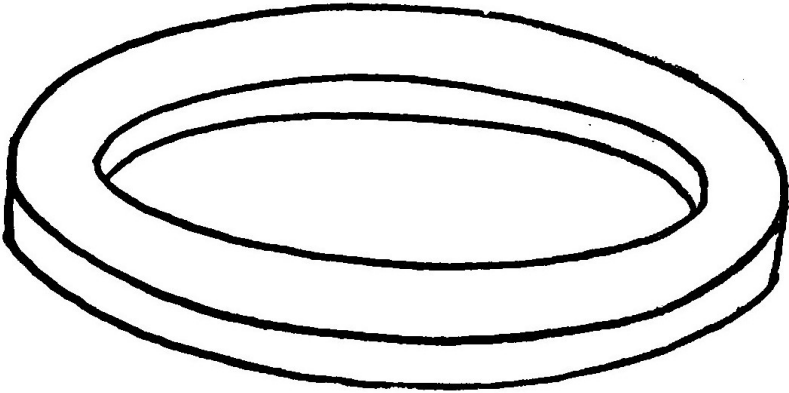

Fig. 304.—Wooden Ring.

Next make two wooden rings about four inches in diameter by cutting them out of a pine board. Place the wires on one of the rings in the manner shown in Figure 305. Place the second ring on top and clamp it down by means of two or three screws.

The inner junctures of the wires must not touch each other. The outer ends should be bent out straight and be spaced equidistantly. The ring should be supported by three iron rods or legs. The two terminals of the thermopile as the instrument is called, should be connected to binding-posts.

Place a small alcohol lamp or Bunsen burner in the center, so that the flame will play on the inner junctures of the wires. A thermopile of the size and type just described will deliver a considerable amount of electrical energy when the inside terminals are good and hot and the outside terminals fairly good.

The current may be very easily detected by connecting the terminals to a telephone receiver or galvanometer. By making several thermopiles and connecting them in parallel, sufficient current can be obtained to light a small lamp.

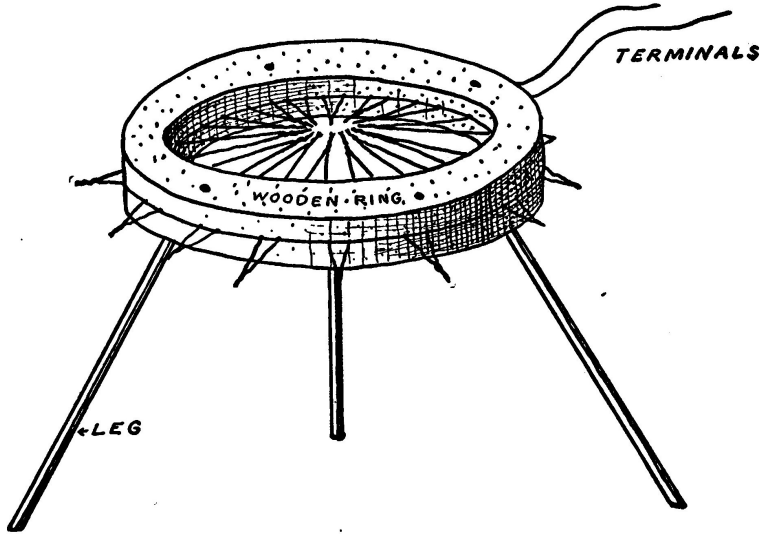

Fig. 305.—Complete Thermopile. An Alcohol Lamp should be lighted and placed so that the Flame heats the Inside Ends of the Wires in the Center of the Wooden Ring.

HOW TO MAKE A REFLECTOSCOPE

A reflectoscope is a very simple form of a "magic lantern" with which it is possible to show pictures from post-cards, photographs, etc. The ordinary magic lantern requires a transparent lantern slide, but the reflectoscope will make pictures from almost anything. The picture post-cards or the photographs that you have collected during your vacation may be thrown on a screen and magnified to three or four feet in diameter. Illustrations clipped from a magazine or newspaper or an original sketch or painting will likewise show just as well. Everything is projected in its actual colors. If you put your watch in the back of the lantern, with the wheels and works exposed, it will show all the metallic colors and the parts in motion.

The reflectoscope, shown in Figure 306, consists of a rectangular box nine inches long, six inches wide, and six inches high outside. It may be built of sheet-iron or tin, but is most easily made from wood. Boards three-eighths of an inch thick are heavy enough. The methods of making an ordinary box are too simple to need description. The box or case in this instance, however, must be carefully made and be "light-tight," that is, as explained before, it must not contain any

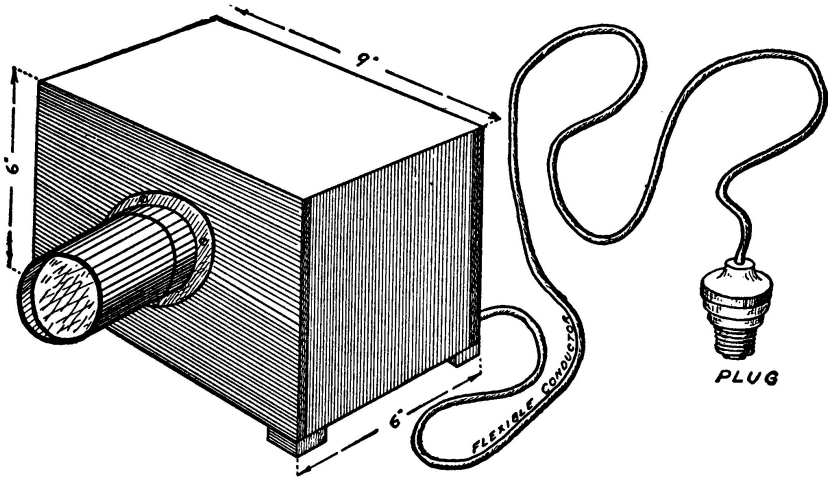

Fig. 306.—A Reflectoscope.

cracks or small holes which will allow light to escape if a lamp is placed inside.

A round hole from two and one-half to three inches in diameter is cut in the center of one of the faces of the box.

The exact diameter cannot be given here because it will be determined by the lens which the experimenter is able to secure for his reflectoscope. Only one lens is required. It must be of the "double-convex" variety, and be from two and one-half to three inches in diameter. A lens is very easily secured from an old bicycle lantern. It should be of clear glass.

A tube, six inches long and of the proper diameter to fit tightly around the lens, must be made by rolling up a piece of sheet-tin and soldering the edges together. This tube is the one labeled "movable tube" in the illustrations. A second tube, three inches long and of the proper diameter to just slip over the first tube, must also be made. A flat ring cut from stiff sheet-brass is soldered around the outside of this second tube, so that it may be fastened to the front of the case by three or four small screws in the manner shown. The hole in the front of the box should be only large enough to receive the tube.

The lens is held in position near one end of the movable tube by two strong wire rings. These rings should be made of wire that is heavy and rather springy, so that they will tend to open against the sides of the tube. It is a good plan to solder one of them in position, so that it cannot move, and then put in the lens.

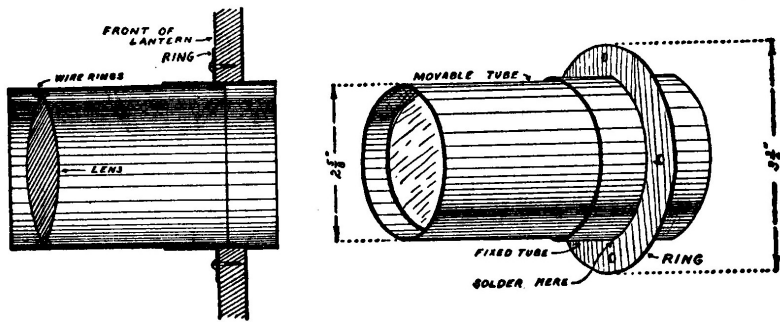

Fig. 307.—How the Lens is Arranged and Mounted.

After the lens is in position, the second ring should be put in and pushed down against the lens. Do not attempt to put the lens in, however, until you are sure that the metal has cooled again after soldering, or it will be liable to crack.

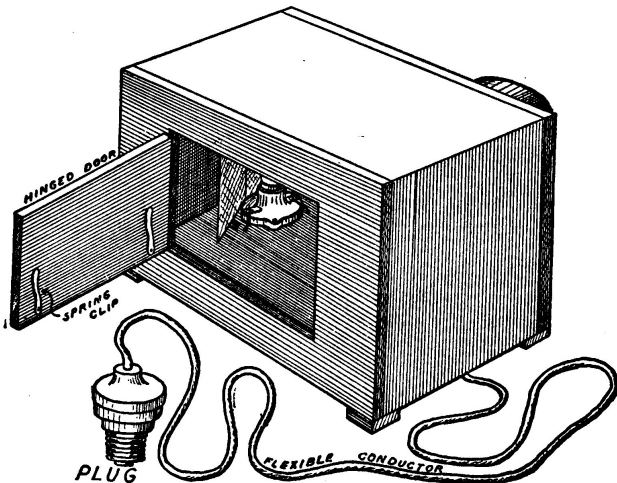

Fig. 308.—A View of the Reflectoscope from the Rear, showing the Door, etc.

The back of the box contains a small hinged door about four inches high

and five and one-half inches long. The pictures that it is desired to project on the screen are held against this door by two small brass clips, as shown in Figure 308.

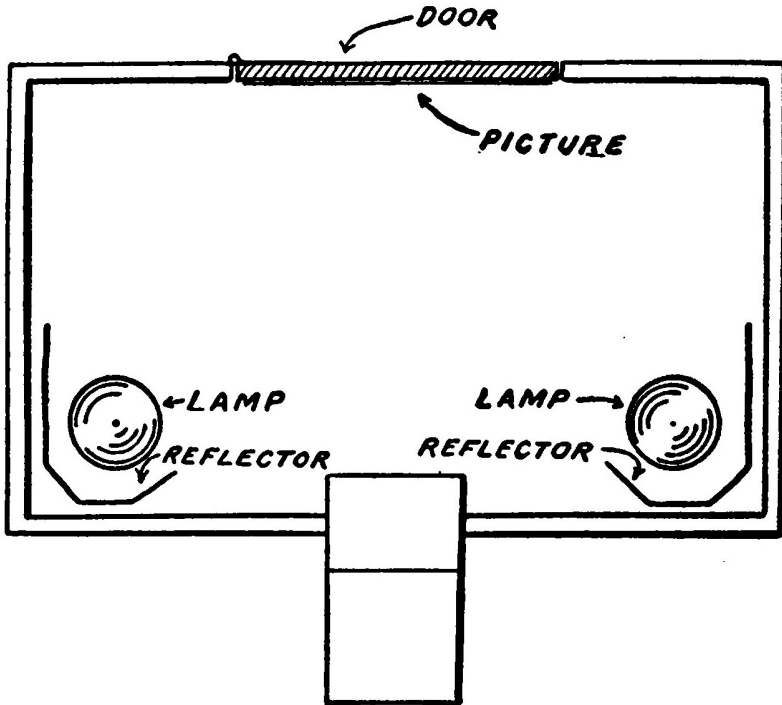

Fig. 309.—A View of the Reflectoscope with the Cover removed, showing the Arrangement of the Lamps, etc.

The light for the reflectoscope is most conveniently made by two 16-candle-power electric incandescent lamps. Figure 309 shows a view of the inside of the box with the cover removed, looking directly down. The lamps fit into ordinary flat-base porcelain receptacles, such as that shown in Figure 310. Two of these receptacles are required, one for each lamp. They cost about ten cents each.

The reflectors are made of tin, bent as shown in Figure 311. They are fastened in position behind the lamps by four small tabs.

It is possible to fit a reflectoscope with gas or oil lamp to supply the light, but in that case the box will have to be made much larger, and provided with

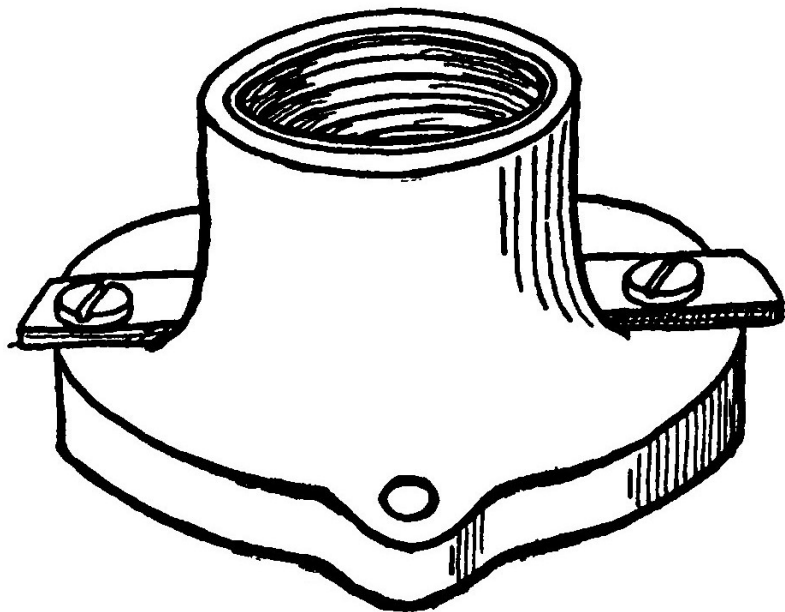

Fig. 310.—A Socket for holding the Lamp.

chimneys to carry off the hot air.

The interior of the reflectoscope must be painted a dead black by using a paint made by mixing lampblack and turpentine. The interior also includes the inside of the tin tubes.

The electric current is led into the lamps with a piece of flexible lamp-cord passing through a small hole in the case. An attachment-plug is fitted to the other end of the cord, so that it may be screwed into any convenient lamp-socket.

The pictures should be shown in a dark room and projected on a smooth white sheet. They are placed under the spring clips on the little door and the door closed. The movable tube is then slid back and forth until the picture on the screen becomes clear and distinct.

The lantern may be improved considerably by using tungsten lamps of 22 c. p. each in place of ordinary c. p. carbon filament lamps.

If four small feet, one at each corner, are attached to the bottom of the case, its appearance will be much improved.

Very large pictures will tend to appear a little blurred at the corners. This

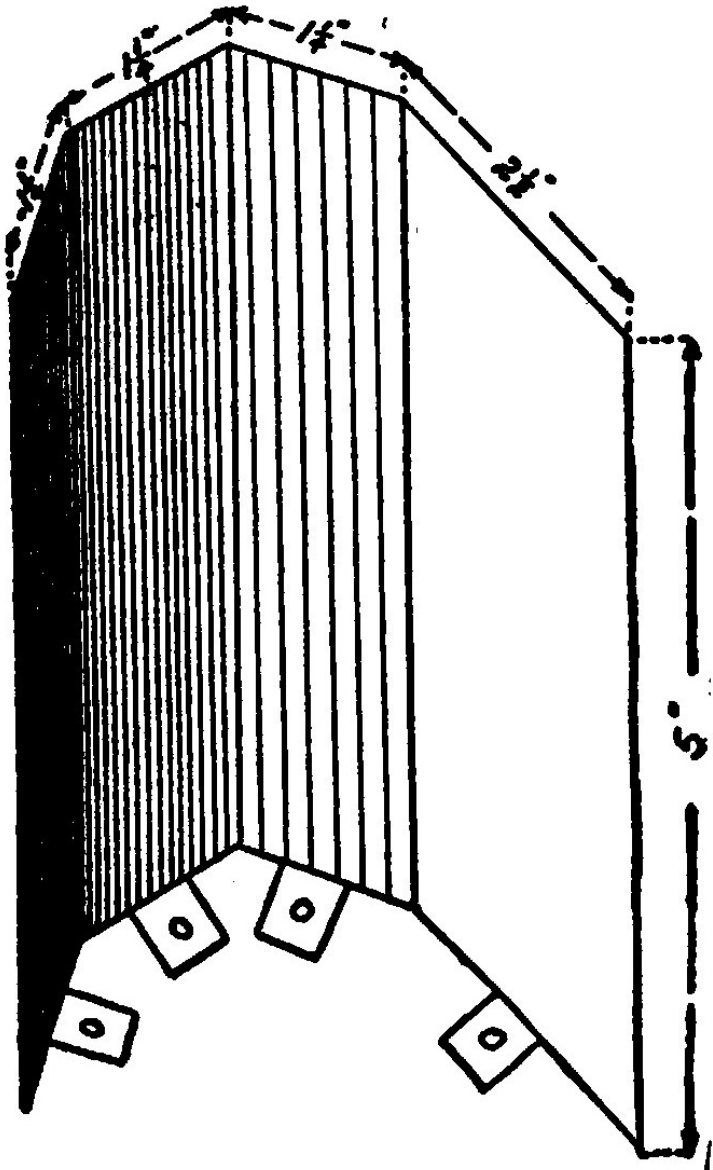

Fig. 311.—The Tin Reflector.

is due to the lens and cannot be easily remedied.

HOW TO REDUCE THE 110-v. CURRENT SO THAT IT MAY BE USED FOR EXPERIMENTING

Oftentimes it is desirable to operate small electrical devices from the 110-v. lighting or power circuits. Alternating current can be reduced to the proper voltage by means of a small step-down transformer, such as that described in Chapter XIII. Direct current may be reduced by means of a resistance. The most suitable form of resistance for the young experimenter to use is a "lamp bank."

A lamp bank consists of a number of lamps connected in parallel, and arranged so that any device may be connected in series with it.

The lamps are set in sockets of the type known as "flat-base porcelain receptacles," such as that shown in Figure 310, mounted in a row upon a board and connected as shown in Fig. 312.

The current from the power line enters through a switch and a fuse and then passes through the lamps before it reaches the device it is desired to operate. The switch is for the purpose of shutting the current on and off, while the fuse will "blow" in case too much current flows in the circuit.

The amount of current that passes through the circuit may be accurately controlled by the size and number of lamps used in the bank. The lamps may be screwed in or out and the current altered by one-quarter of an ampere at a time if desirable.

The lamps should be of the same voltage as the line upon which they are to be used. Each 8-candle-power, 110-v. carbon lamp used will permit one-quarter of an ampere to pass. Each 16-candle-power, 110-v. lamp will pass approximately one-half an ampere. A 32-candle-power lamp of the same voltage will permit one ampere to flow in the circuit.

AN INDUCTION MOTOR

An **Induction Motor** is a motor in which the currents in the armature windings are *induced*. An induction motor runs without any brushes, and the current from the power line is connected only to the field. The field might be likened to the primary of a transformer. The currents in the armature then constitute a secondary winding in which currents are induced in the same manner as in a transformer.

An induction motor will operate only on alternating current.

A small motor such as that shown in Figure 267, and having a three-pole armature, is the best type to use in making an experimental induction motor.

Remove the brushes from the motor and bind a piece of bare copper wire

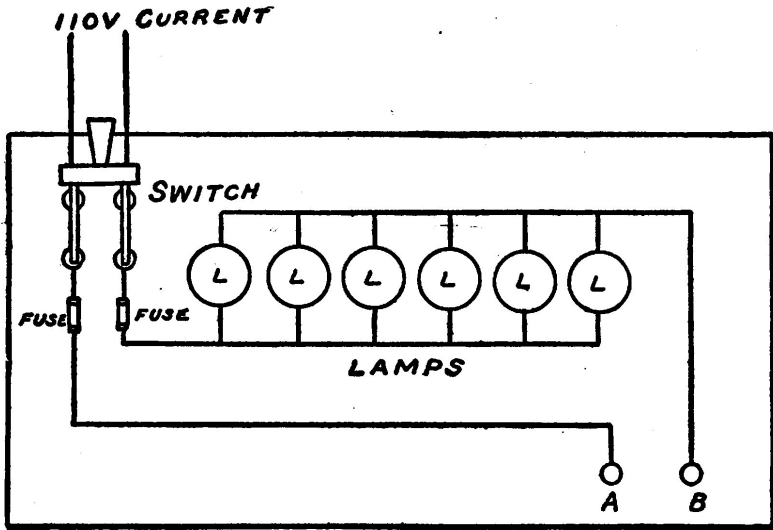

Fig 312.—Top View of Lamp Bank, showing how the Circuit is arranged. A and B are the Posts to which should be connected any Device it's desirable to operate.

around the commutator so that it short-circuits the segments.

A source of alternating current should then be connected to the terminals of the field coil. If you have a step-down transformer, use it for this purpose, but otherwise connect it in series with a lamp bank such as that just described.

Place a switch in the circuit so that the current may be turned on and off. Wind a string around the end of the armature shaft so that it may be revolved at high speed by pulling the string in somewhat the same manner that you would spin a top. When all is ready, give the string a sharp pull and immediately close the switch so that the alternating current flows into the field.

If this is done properly, the motor will continue to run at high speed, and furnish power if desirable.

Most of the alternating-current motors in every-day use for furnishing power for various purposes are induction motors. They are, however, self-starting, and provided with a hollow armature, which contains a centrifugal governor. When the motor is at rest or just starting, four brushes press against the commutator and divide the armature coils into four groups. After the motor has attained the proper speed, the governor is thrown out by centrifugal force and

pushes the brushes away from the commutator, short-circuiting all the sections and making each coil a complete circuit of itself.

ELECTRO-PLATING

Water containing chemicals such as sulphate of copper, sulphuric acid, nitrate of nickel, nitrate of silver, or other metallic salts is a good conductor of electricity. Such a liquid is known as an *electrolyte*.

It has been explained in Chapter IV that chemical action may be used to produce electricity and that in the case of a cell such as that invented by Volta, the zinc electrode gradually wastes away and finally enters into solution in the sulphuric acid.

It is possible exactly to reverse this action and to produce what is known as *electrolysis*. If an electrolyte in which a metal has been "dissolved" is properly arranged so that a current of electricity may be passed through the solution, the metal will "plate out," or appear again upon one of the electrodes.

Electrolysis makes possible electro-plating and thousands of other exceedingly valuable and interesting chemical processes.

More than one-half of all the copper produced in the world is produced *electrolytically*.

Practically all plating with gold, silver, copper and nickel is accomplished with the aid of electricity.

These operations are carried out on a very large scale in the various factories, but it is possible to reproduce them in any boy's workshop or laboratory, with very simple equipment.

The proper chemicals, a tank, and a battery are the only apparatus required. The current must be supplied by storage cells or a bichromate battery because the work will require five or six amperes for quite a long period.

A small rectangular glass jar will make a first class tank to hold the electrolyte.

The simplest electro-plating process, and the one that the experimenter should start with is copper-plating.

Fill the tank three-quarters full of pure water and then drop in some crystals of copper-sulphate until the liquid has a deep blue color and will dissolve no more.

Obtain two copper rods and lay them across the tank. Cut two pieces of sheet copper having a tongue at each of two corners so that they can be hung in the solution, as shown in Figure 313. Hang both of the sheets from one of the copper rods. Connect this rod to the *positive* pole of the battery. These sheets are known as the anodes.

Then if a piece of carbon, or some metallic object is hung from the other

rod and connected to the *negative* pole of the battery, the electro-plating will commence. The apparatus should be allowed to run for about half an hour and then the object hung from the rod connected to the negative pole of the battery should be lifted out and examined. It will be found thickly coated with copper. It is absolutely necessary to have the poles of the battery connected in the manner stated, or no deposit of copper will take place.

Objects which are to be electro-plated must be free from all traces of oil or grease and absolutely clean in every respect, or the plating will not be uniform, because it will not stick to dirty spots.

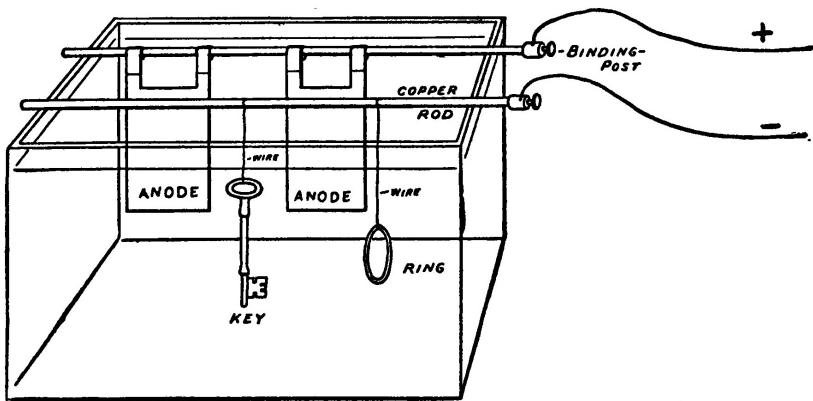

Fig. 313.—A Glass Jar arranged to serve as an Electro-Plating Tank.

Such articles as keys, key-rings, tools, etc., can be prevented from rusting by coating with nickel.

Nickel-plating is very similar to copper-plating. Instead, however, of having two copper sheets suspended from the rod connected to the positive pole of the battery, they must be made of nickel.

The electrolyte is composed of one part of nickel-sulphate dissolved in twenty parts of water to which one part of sodium-bisulphate is added.

This mixture is placed in the tank instead of the copper-sulphate. The objects to be plated are hung from the copper rod connected to the negative pole of the battery.

When the nickel-plated articles are removed from the bath they will have a dull, white color known as "white nickel." When white nickel is polished with a cloth wheel revolving at high speed, and known as a buffing-wheel, it will assume

a high luster.

HOW TO MAKE A RHEOSTAT

It is often desirable to regulate the amount of current passing through a small lamp, motor, or other electrical device operated by a battery.

This is accomplished by inserting resistance into the circuit. A rheostat is an arrangement for quickly altering the amount of resistance at will.

A simple rheostat is easily made by fitting a five-point switch such as that shown in Figure 95 with several coils of German-silver resistance wire. German silver has much more resistance than copper wire, and is used, therefore, because less will be required, and it will occupy a smaller space.

A five-point switch will serve satisfactorily in making a rheostat, but if a finer graduation of the resistance is desired it will be necessary to use one having more points.

Two lines of small wire nails are driven around the outside of the points, and a German-silver wire of No. 24 B. & S. gauge wound in zig-zag fashion around the nails from one point to the other.

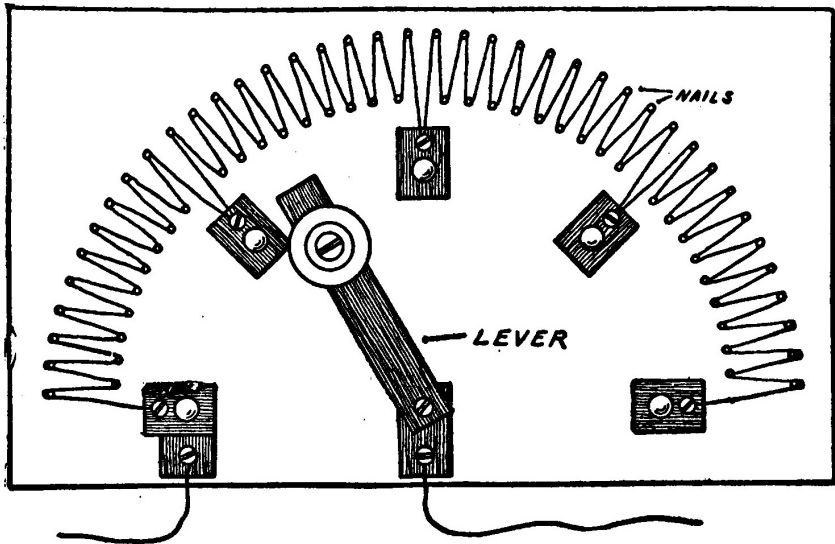

Fig. 314.—A Rheostat.

The rheostat is placed in series with any device it is desirable to control. When the handle is on the point to the extreme left, the rheostat offers no resistance to the current. When the lever is placed on the second point, the current has to traverse the first section of the German-silver wire and will be appreciably affected. Moving the handle to the right will increase the resistance.

If the rheostat is connected to a motor, the speed can be increased or decreased by moving the lever back and forth.

In the same manner, the light from a small incandescent lamp may be dimmed or increased.

A CURRENT REVERSER OR POLE-CHANGING SWITCH

A pole-changing or current reversing switch is useful to the experimenter. For example, if connected to a small motor, the motor can be made to run in either direction at will. A motor with a permanent magnet field can be reversed by merely changing the wires from the battery so that the current flows through the circuit in the opposite direction. If the motor is provided with a field winding, however, the only way that it can be made to run either way is by reversing the field. This is best accomplished with a pole-changing switch.

Such a switch may be made by following the same general method of construction as that outlined on pages 107 and 108, but making it according to the design shown in Figure 315.

Motors such as those illustrated can be made to reverse by connecting to a pole-changing switch in the proper manner.

The two outside points or contacts (marked *D* and *D*) should both be connected to one of the brushes on the motor. The middle contact, *C*, is connected to the other brush.

One terminal of the field is connected to the battery. The other terminal of the field is connected to the lever, *A*. *B* connects to the other terminal of the battery.

When the switch handle is pushed to the left, the lever *A* should rest on the left-hand contact, *D*. The lever *B* should make contact with *C*. The motor will then run in one direction. If the handle is pushed to the right so that the levers *A* and *B* make contact respectively with *C* and *D* (right-hand), the motor will reverse and run in the opposite direction.

A COMPLETE WIRELESS RECEIVING SET

Many experimenters may wish to build a wireless receiving set which is permanently connected and in which the instruments are so mounted that they are

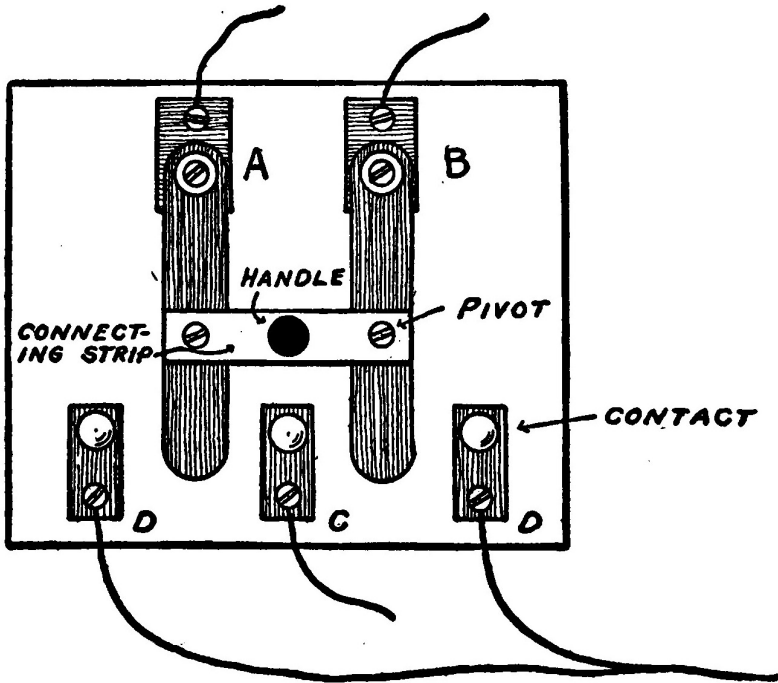

Fig. 315.—A Pole-Changing Switch or Current Reverser. The Connecting Strip is pivoted so that the Handle will operate both the Levers, A and B.

readily portable and may be easily shifted from one place to another without having to disturb a number of wires.

The receiving set shown in Figure 316 is made up of some of the separate instruments described in Chapter XIV, and illustrates the general plan which may be followed in arranging an outfit in this manner.

The base is of wood, and is nine inches long, seven inches wide, and one-half of an inch thick.

A double-slider tuning coil, similar to that shown in Figure 203, is fastened to the back part of the base by two small wood-screws passing upwards through the base into the tuner heads.

The fixed condenser is enclosed in a rectangular wooden block which is hollowed out underneath to receive it and then screwed down to the base in the

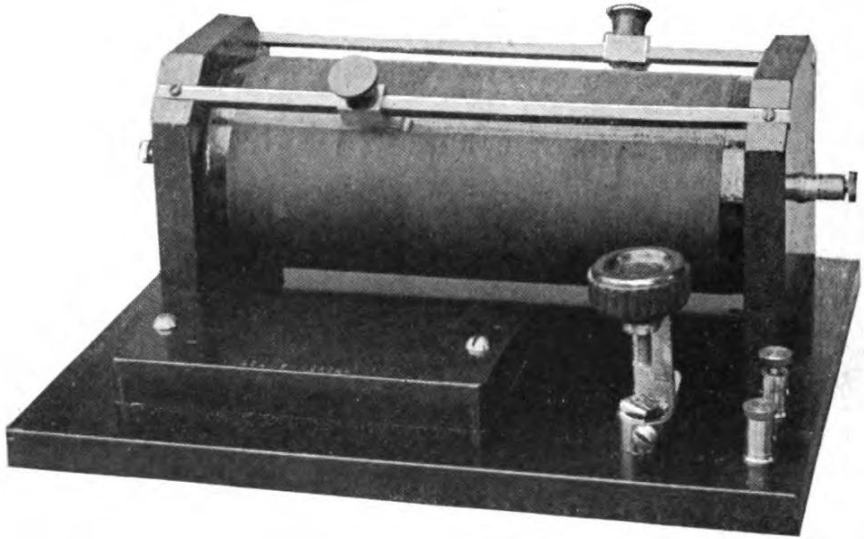

COMPLETE RECEIVING SET, CONSISTING OF DOUBLE SLIDER TUNING COIL, DETECTOR AND FIXED CONDENSER.

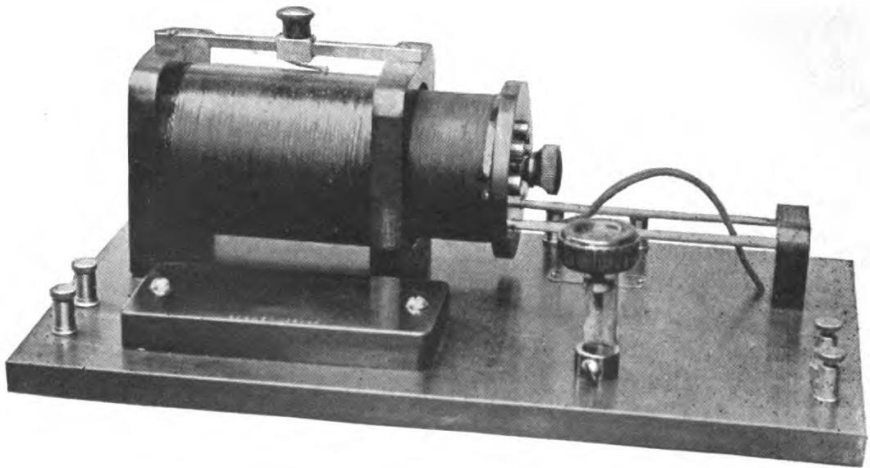

COMPLETE RECEIVING SET, CONSISTING OF A LOOSE COUPLER IN PLACE OF THE TUNING COIL, DETECTOR AND FIXED CONDENSER.

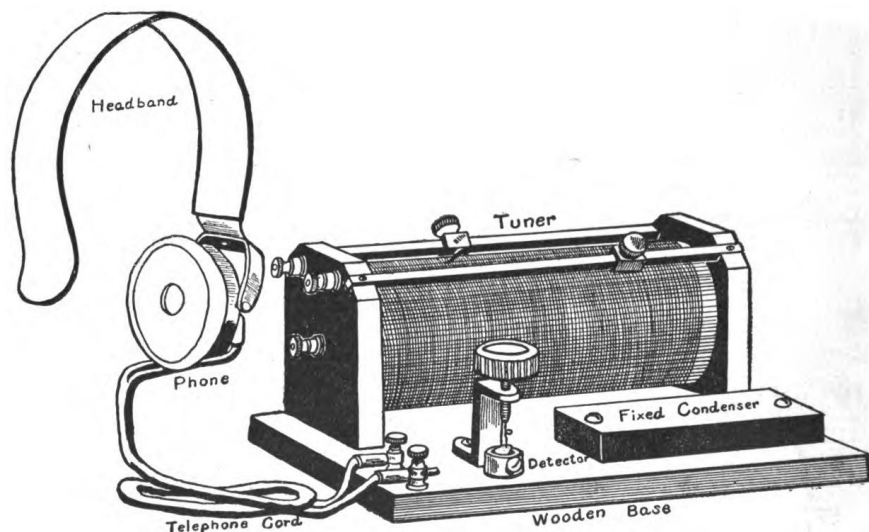

Fig. 316. A Complete Wireless Receiving Outfit.

forward right-hand corner.

The detector is mounted in the forward left-hand part of the base, and in the illustration is shown as being similar to that in Figure 210. Any type of detector may, however, be substituted.

The tuning coil may be replaced by a loose coupler if desirable, but in that case the base will have to be made larger.

The telephone receivers are connected to two binding-posts mounted alongside the detector.

The circuit shown in Figure 218 is the one which should be followed in wiring the set. The wires which connect the various instruments should be passed through holes and along the under side of the base so that they are concealed.

HOW TO BUILD A TESLA HIGH-FREQUENCY COIL

A Tesla high-frequency coil or transformer opens a field of wonderful possibilities for the amateur experimenter. Innumerable weird and fascinating experiments can be performed with its aid.

When a Leyden jar or a condenser discharges through a coil of wire, the

spark which can be seen does not consist simply of a single spark passing in one direction, as it appears to the eye, but in reality is a number of separate sparks alternately passing in opposite directions. They move so rapidly that the eye is unable to distinguish them. The time during which the spark appears to pass may only be a fraction of a second, but during that short period the current may have oscillated back and forth several thousand times.

If the discharge from such a Leyden jar or a condenser is passed through a coil of wire acting as a *primary*, and the primary is provided with a *secondary* coil containing a larger number of turns, the secondary will produce a peculiar current known as *high-frequency* electricity. High-frequency currents reverse their direction of flow or *alternate* from one hundred thousand to one million times a second.

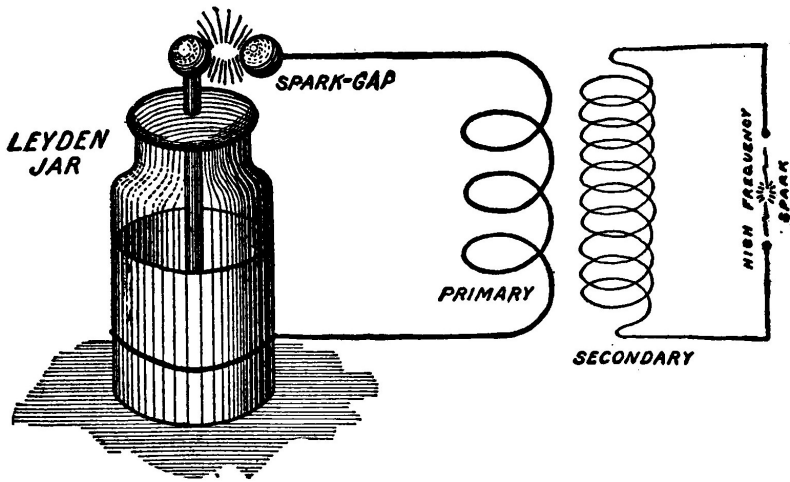

Fig. 317.—Illustrating the Principle of the Tesla Coil. A Leyden Jar discharges through the Primary Coil and a High-Frequency Spark is produced at the Secondary.

High-frequency currents possess many curious properties. They travel only on the surface of wires and conductors. A hollow tube is just as good a conductor for high-frequency currents as a solid rod of the same diameter. High-frequency currents do not produce a shock. If you hold a piece of metal in your hand you can take the shock from a high-frequency coil throwing a spark two or three feet long with scarcely any sensation save that of a slight warmth.

The Tesla coil described below is of a size best adapted for use with a two-inch or three-inch spark coil, or a small high-potential wireless transformer. The purpose of the spark coil or the transformer is to charge the Leyden jars or condenser which discharge through the primary of the Tesla coil.

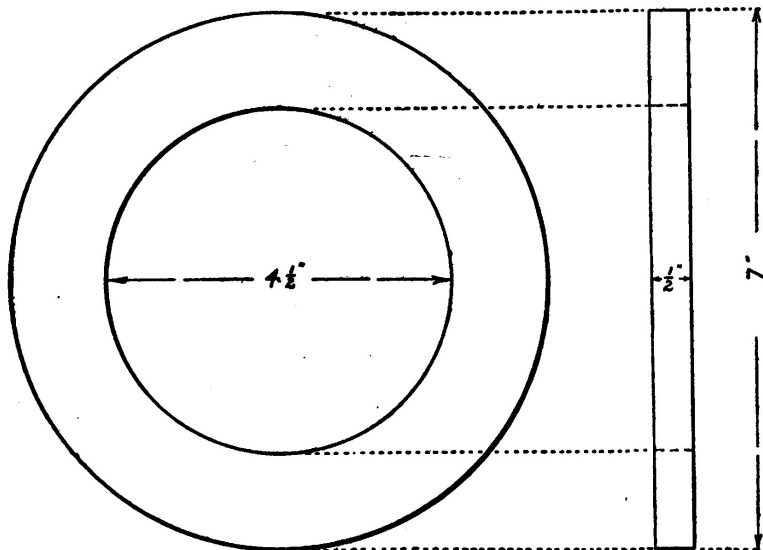

Fig. 318.—Details of the Wooden Rings used as the Primary Heads.

If the young experimenter wishes to make a Tesla coil which will be suited to a smaller spark coil, for instance, one capable of giving a one-inch spark, the dimensions of the Tesla coil herein described can be cut exactly in half. Instead of making the secondary twelve inches long and three inches in diameter, make it six inches long and one and one-half inches in diameter, etc.

The **Primary** consists of eight turns of No. 10 B. & S. gauge copper wire wound around a drum. The heads of the drum are wooden rings, seven inches in diameter and one-half inch thick. A circular hole four and one-half inches in diameter is cut in the center of each of the heads.

The cross bars are two and one-half inches long, three-quarters of an inch thick and one-half of an inch wide. Six cross bars are required. They are spaced at equal distances around the rings and fastened by means of a *brass* screw passing

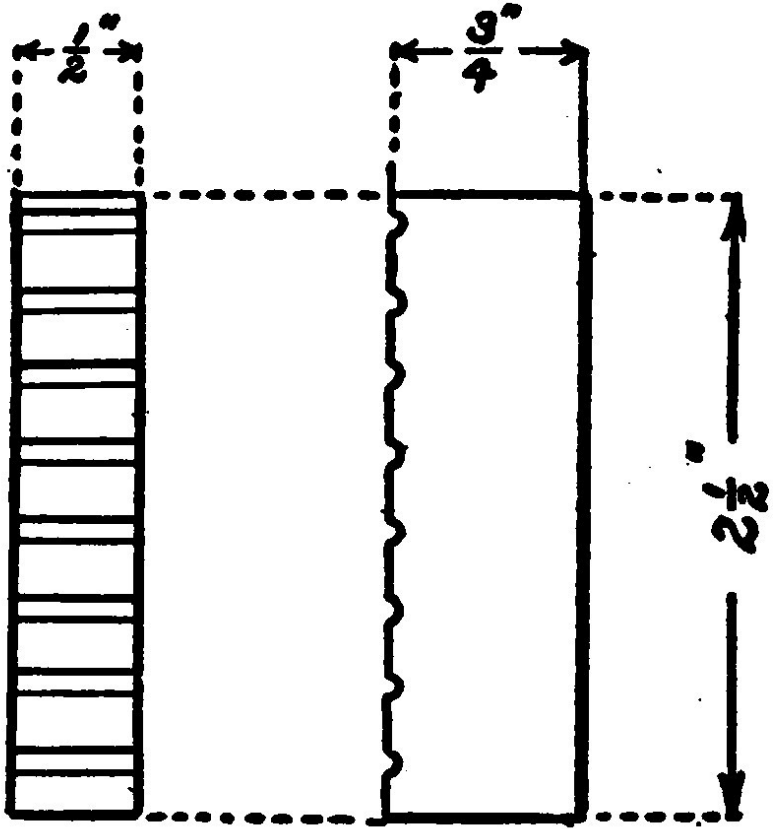

Fig. 319.—Details of the Cross Bars which support the Primary Winding.

through the ring. When the drum is completed it should resemble a "squirrel cage."

Small grooves are cut in the cross bars to accommodate the wire. The wires should pass around the drum in the form of a spiral and be spaced about five-sixteenths of an inch apart.

The ends of the wire should be fastened to binding-posts mounted on the heads.

The Secondary is a single layer of No. 26 B. & S. silk- or cotton-covered wire wound over a cardboard tube, twelve inches long and three inches in diameter.

The tube should be dried in an oven and then given a thick coat of shellac, both inside and out, before it is used. This treatment will prevent it from shrinkage and avoid the possibility of having to rewind the tube in case the wire should become loose.

The secondary is fitted with two circular wooden heads just large enough to fit tightly into the tube, having a half-inch flange, and an outside diameter of three and seven-eighths inches.

The Base of the coil is fifteen inches long and six inches wide and is made of wood.

The coil is assembled by placing the primary across the base and exactly in the center. Two long wood-screws passing through the base and into the primary heads will hold it firmly in position.

The secondary is passed through the center of the primary and supported in that position by two hard rubber supports, four inches high, seven-eighths of an inch wide and one-half of an inch thick. A brass wood-screw is passed through the top part of each of the supports into the secondary heads so that a line drawn through the axis of the secondary will coincide with a similar line drawn through the axis of the primary.

The supports are made of hard rubber instead of wood, because the rubber has a greater insulating value than the wood. High-frequency currents are very hard to insulate, and wood does not usually offer sufficient insulation.

A brass rod, five inches long and having a small brass ball at one end, is mounted on the top of each of the hard-rubber supports. The ends of the secondary winding are connected to the brass rods.

The lower end of each of the hard-rubber supports is fastened to the base by means of a screw passing through the base into the support.

In order to operate the Tesla coil, the primary should be connected in series with a condenser and a spark-gap as shown in Figure 324. The condenser may consist of a number of Leyden jars or of several glass plates coated with tinfoil. It is impossible to determine the number required ahead of time, because the length of the connecting wires, the spark-gap, etc., will have considerable

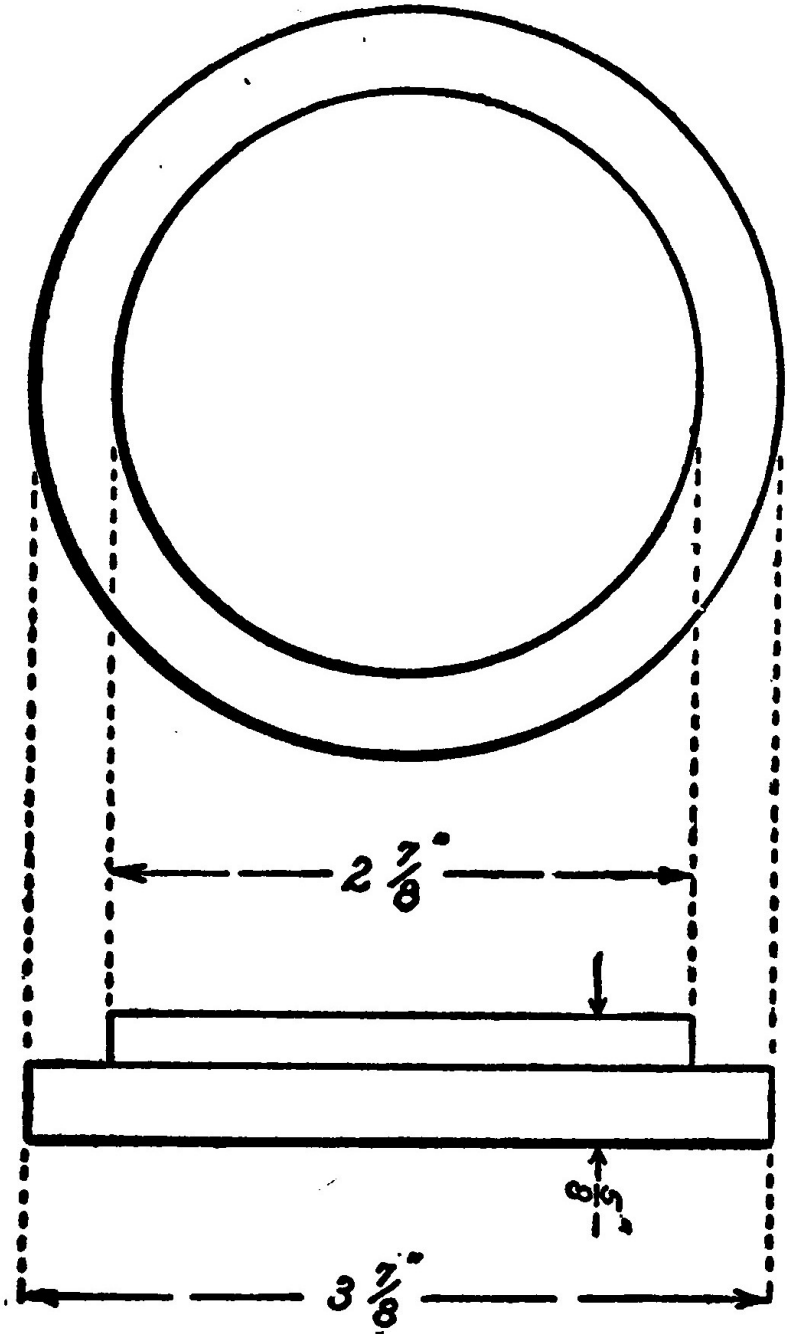
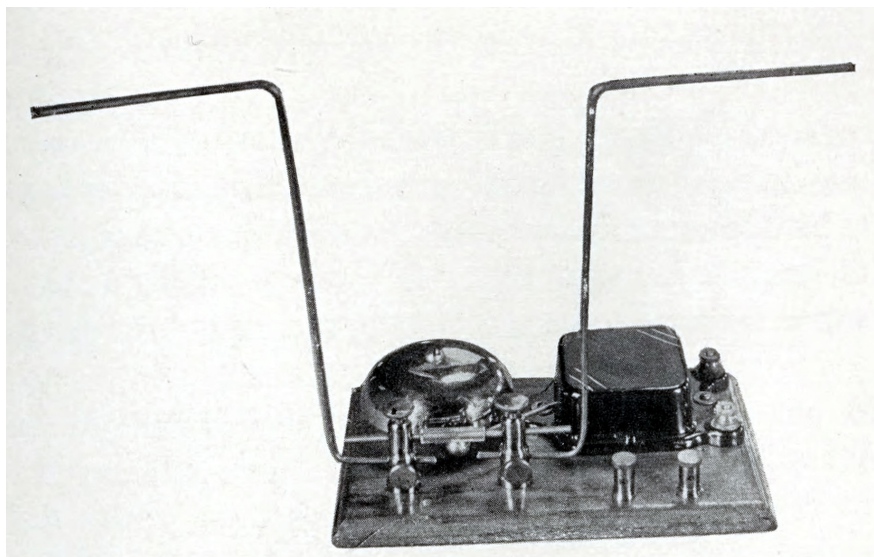

Fig. 320—The Secondary Head



A COMPLETE COHERER OUTFIT AS DESCRIBED ON PAGE 274.

influence upon the amount of condenser required. The condenser is connected directly across the secondary terminals of the spark coil.

When the spark coil is connected to a battery and set into operation, a snappy, white spark should jump across the spark-gap.

If the hand is brought close to one of the secondary terminals of the Tesla coil, a small reddish-purple spark will jump out to meet the finger.

Adjusting the spark-gap by changing its length and also altering the number of Leyden jars of condenser plates will probably increase the length of the high-frequency spark. It may be possible also to lengthen the spark by disconnecting one of the wires from the primary binding-posts on the Tesla coil and connecting the wire directly to one of any one of the turns forming the primary. In this way the number of turns in the primary is changed and the circuit is *tuned* in the same way that wireless apparatus is tuned by changing the number of turns in the tuning coil or helix.

The weird beauty of a Tesla coil is only evident when it is operated in the dark. The two wires leading from the secondary to the brass rods and the ball on the ends of the rods will give forth a peculiar *brush* discharge.

If you take a piece of metal in your hand and hold it near one of the sec-

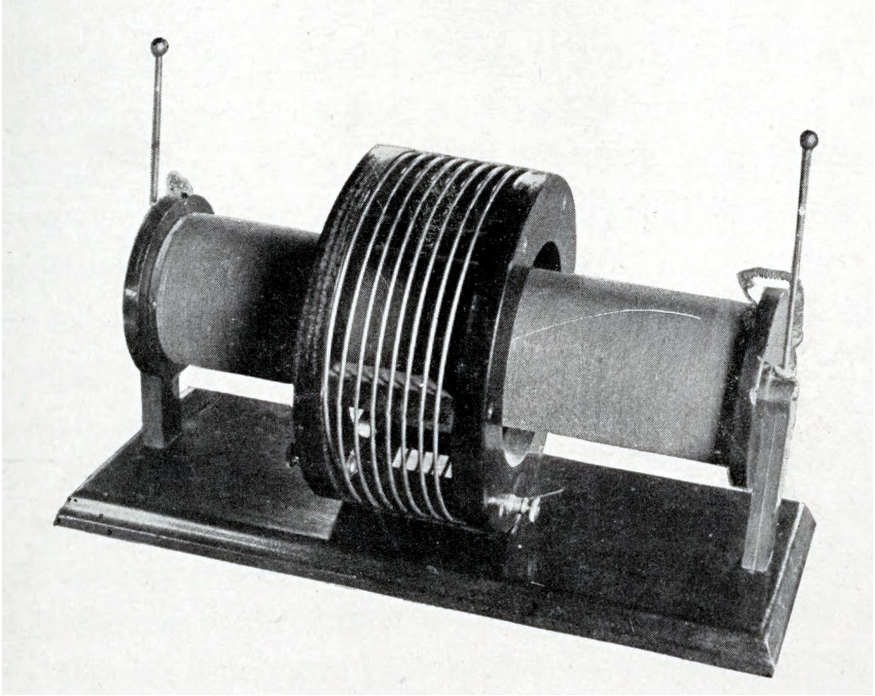

THE TESLA HIGH FREQUENCY COIL.

ondary terminals, the brushing will increase. If you hold your hand near enough, a spark will jump on to the metal and into your body without your feeling the slightest sensation.

If one of the secondary terminals of the Tesla coil is *grounded* by means of a wire connecting it to the primary, the brushing at the other terminal will increase considerably.

Make two rings out of copper wire. One of them should be six inches in diameter and the other one four inches in diameter. Place the small ring inside the large one and connect them to the secondary terminals. The two circles should be arranged so as to be *concentric*, that is, so that they have a common center.

The space between the two coils will be filled with a pretty brush discharge when the coil is in operation.

There are so many other experiments which may be performed with a Tesla coil that it is impossible even to think of describing them here, and the young ex-

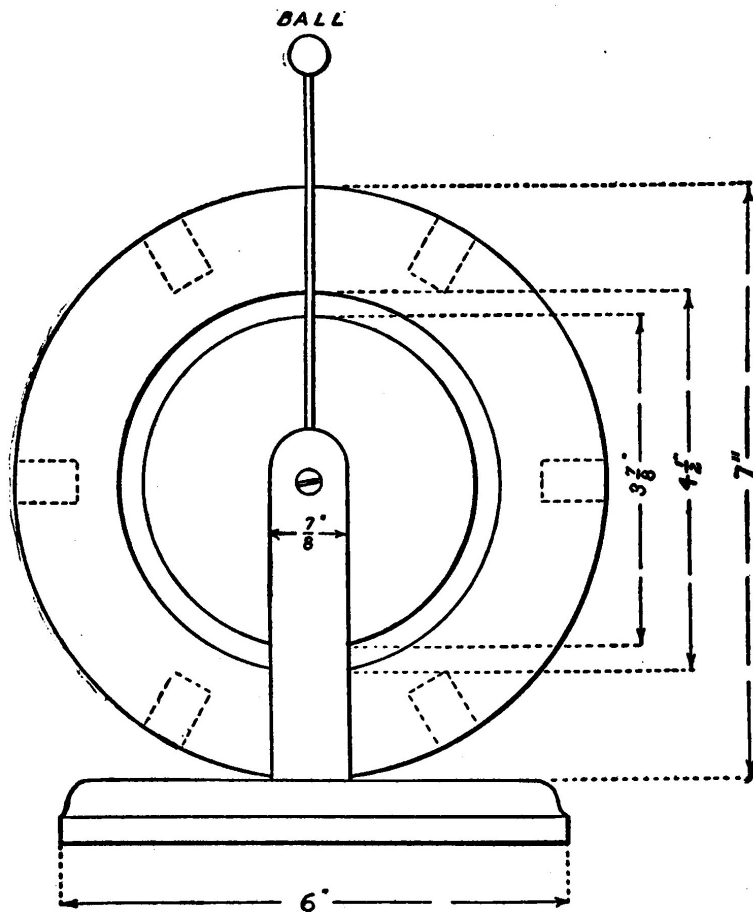

Fig. 321.—End View of the Complete Tesla Coil.

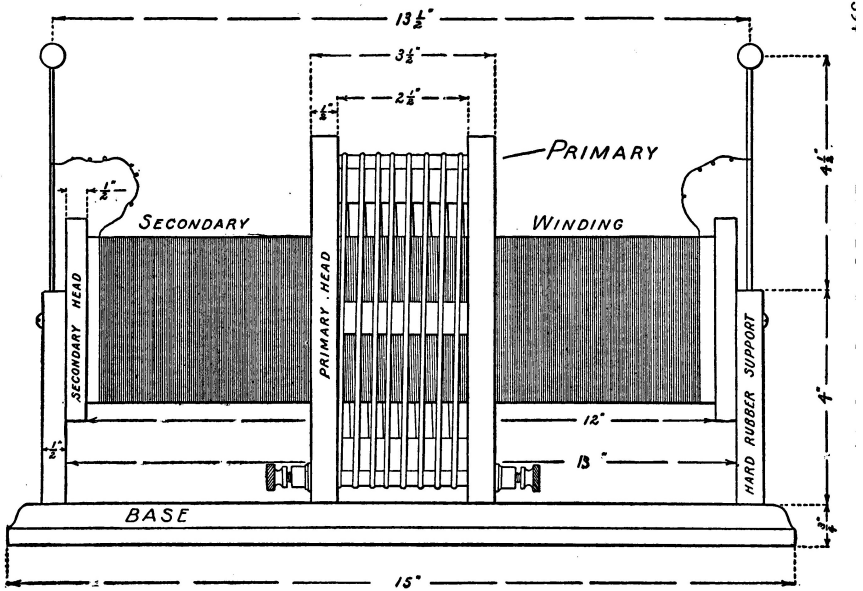

Fig. 322.—The Complete Tesla Coil.

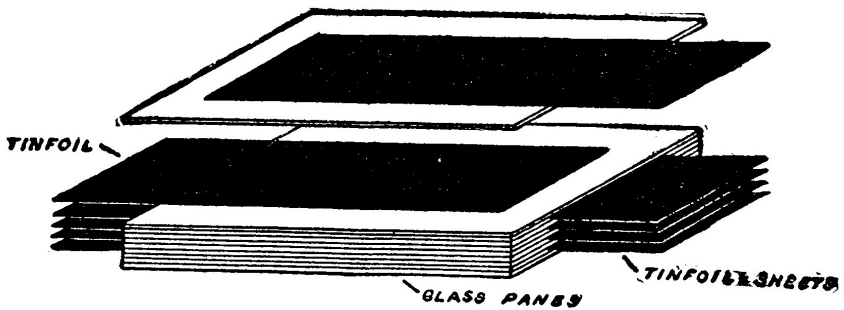

Fig 323.—Showing how a Glass-Plate Condenser is built up of Alternate Sheets of Tinfoil and Glass.

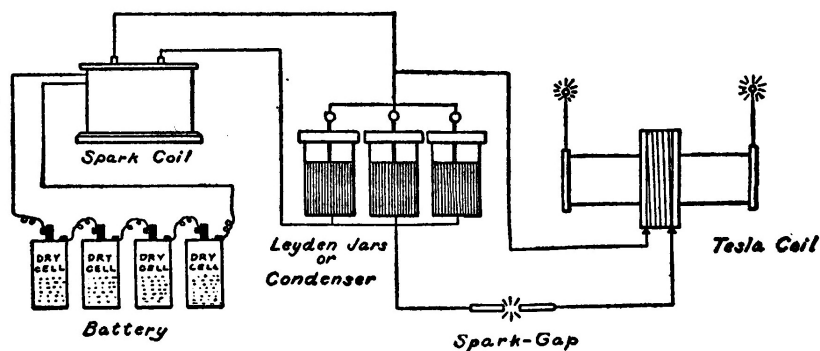

Fig. 324.—A Diagram showing the Proper Method of Connecting a Tesla Coil.

perimeter wishing to continue the work further is advised to go to some library and consult the works of Nikola Tesla, wherein such experiments are fully explained.

CONCLUSION

Unless the average boy has materially changed his habits, in recent years, it matters not what the preface of a book may contain, for it will be unceremoniously skipped with hardly more than a passing glance. With this in mind, the author has tried to "steal a march" on you, and instead of writing a longer preface, and including some material which might properly belong in that place, has added it here in the nature of a conclusion, thinking that you would be more likely to read it last than first.

Some time ago, when in search for something that might be described in this book, I thought of some old boxes into which my things had been packed when I had dismantled my workshop before going away to college. They had been undisturbed for a number of years and I had almost forgotten where they had been put. At last a large box was unearthed from amongst a lot of dusty furniture put away in the attic. I pried the cover off and took the things out one by one and laid them on the floor. Here were galvanometers, microphones, switches, telegraph keys, sounders, relays, and other things too numerous to mention. They had all been constructed so long ago that I was considerably amused and interested in the manner in which bolts, screws, pieces of curtain

rod, sheet-iron, brass, and other things had been taken to form various parts of the instruments. The binding-posts had almost in every case seen service as such on dry cells before they came into my hands. The only parts that it had been necessary to buy were a few round-headed brass screws and the wire which formed the magnets. In several instances, the latter were made so that they might be easily removed and mounted upon another instrument. The magnets on the telegraph sounder could be removed and fitted to form part of an electric engine or motor.

One particular thing which struck me very forcibly was the lack of finish and the crudeness which most of the instruments showed.

Of course it was impossible to avoid the clumsy appearance which the metal parts possessed, since they were not originally made for the part that they were playing, but I wished that I had taken a little more care to true up things properly or to smooth and varnish the wood, or that I had removed the tool-marks and dents from the metal work by a little filing.

If I had done so, I should now be distinctly proud of my work. That is not to say that I am in the least ashamed of it, for my old traps certainly served their purpose well, even if they were not ornamental and were better back in their box. Perhaps I might be excused for failing in this part of the work through lack of proper tools, and also because at that time there were no magazines or books published which explained how to do such things, and when I built my first tuning coils and detectors nothing on that subject had ever been published. I had to work out such problems for myself, and gave more thought to the principles upon which the instruments operated than to their actual construction.

The boys who read this book have the advantage of instructions showing how to build apparatus that has actually been built and tested. You know what size of wire to use and will not have to find it out for yourself. For that reason you ought to be able to give more time to the construction of such things. The purpose of this conclusion is simply a plea for better work. The American boy is usually careless in this regard. He often commences to build something and then, growing tired before it is finished, lays it aside only to forget it and undertake something else. *Finish whatever you undertake.* The principle is a good one. Remember also that care with the little details is what insures success in the whole.

If in carrying out your work, you get an idea, do not hesitate to try it. A good idea never refused to be developed. It is not necessary to stick absolutely to the directions that I have given. They will insure success if followed, but if you think you can make an improvement, do so.

Of course, such a book as this cannot, in the nature of things, be exhaustive, nor is it desirable, in one sense, that it should be.

I have tried to write a book which, considered as a whole, would prove to be exhaustive only in that it treats of almost every phase of practical electricity.

The principle in mind has been to produce a work which would stimulate the inventive faculties in boys, and to guide them until face to face with those practical emergencies in which no book can be of any assistance but which must be overcome by common sense and the exercise of personal ingenuity.

The book is not as free from technical terms or phrases, as it lay in my power to make it, because certain of those terms have a value and an every-day use which are a benefit to the young experimenter who understands them.

Any one subject treated in the various chapters of the "Boy Electrician" may be developed far beyond that point to which I have taken it. The railroad system could be fitted with electric signals, drawbridges, and a number of other devices.

Many new ideas suggest themselves to the ready-witted American boy. I shall always be pleased to hear from any boy who builds any of the apparatus I have described, and, if possible, to receive photographs of the work. I should be glad to be of any assistance to such a lad, but remember that some of the drawings and text in this book required many hours even to complete a small portion, and therefore please do not write to ask how to build other apparatus not described herein. And, as the future years bring new inventions and discoveries, no one now knows but that, some day, perhaps I will write another "Boy Electrician."

THE END.

*** END OF THIS PROJECT GUTENBERG EBOOK THE BOY ELECTRICIAN ***

A Word from Project Gutenberg

We will update this book if we find any errors.

This book can be found under: <https://www.gutenberg.org/ebooks/63207>

Creating the works from print editions not protected by U.S. copyright law means that no one owns a United States copyright in these works, so the Foundation (and you!) can copy and distribute it in the United States without permission and without paying copyright royalties. Special rules, set forth in the General Terms of Use part of this license, apply to copying and distributing Project Gutenberg™ electronic works to protect the Project Gutenberg™ concept and trademark. Project Gutenberg is a registered trademark, and may not be used if you charge for the eBooks, unless you receive specific permission. If you do not charge anything for copies of this eBook, complying with the rules is very easy. You may use this eBook for nearly any purpose such as creation of derivative works, reports, performances and research. They may be modified and printed and given away – you may do practically *anything* in the United States with eBooks not protected by U.S. copyright law. Redistribution is subject to the trademark license, especially commercial redistribution.

The Full Project Gutenberg License

Please read this before you distribute or use this work.

To protect the Project Gutenberg™ mission of promoting the free distribution of electronic works, by using or distributing this work (or any other work associated in any way with the phrase “Project Gutenberg”), you agree to comply with all the terms of the Full Project Gutenberg™ License available with this file or online at <https://www.gutenberg.org/license>.

Section 1. General Terms of Use & Redistributing Project Gutenberg™ electronic works

1.A. By reading or using any part of this Project Gutenberg™ electronic work,

you indicate that you have read, understand, agree to and accept all the terms of this license and intellectual property (trademark/copyright) agreement. If you do not agree to abide by all the terms of this agreement, you must cease using and return or destroy all copies of Project Gutenberg™ electronic works in your possession. If you paid a fee for obtaining a copy of or access to a Project Gutenberg™ electronic work and you do not agree to be bound by the terms of this agreement, you may obtain a refund from the person or entity to whom you paid the fee as set forth in paragraph 1.E.8.

1.B. “Project Gutenberg” is a registered trademark. It may only be used on or associated in any way with an electronic work by people who agree to be bound by the terms of this agreement. There are a few things that you can do with most Project Gutenberg™ electronic works even without complying with the full terms of this agreement. See paragraph 1.C below. There are a lot of things you can do with Project Gutenberg™ electronic works if you follow the terms of this agreement and help preserve free future access to Project Gutenberg™ electronic works. See paragraph 1.E below.

1.C. The Project Gutenberg Literary Archive Foundation (“the Foundation” or PGLAF), owns a compilation copyright in the collection of Project Gutenberg™ electronic works. Nearly all the individual works in the collection are in the public domain in the United States. If an individual work is unprotected by copyright law in the United States and you are located in the United States, we do not claim a right to prevent you from copying, distributing, performing, displaying or creating derivative works based on the work as long as all references to Project Gutenberg are removed. Of course, we hope that you will support the Project Gutenberg™ mission of promoting free access to electronic works by freely sharing Project Gutenberg™ works in compliance with the terms of this agreement for keeping the Project Gutenberg™ name associated with the work. You can easily comply with the terms of this agreement by keeping this work in the same format with its attached full Project Gutenberg™ License when you share it without charge with others.

1.D. The copyright laws of the place where you are located also govern what you can do with this work. Copyright laws in most countries are in a constant state of change. If you are outside the United States, check the laws of your country in addition to the terms of this agreement before downloading, copying, displaying, performing, distributing or creating derivative works based on this work or any other Project Gutenberg™ work. The Foundation makes no representations concerning the copyright status of any work in any country outside the United States.

1.E. Unless you have removed all references to Project Gutenberg:

1.E.1. The following sentence, with active links to, or other immediate ac-

cess to, the full Project Gutenberg™ License must appear prominently whenever any copy of a Project Gutenberg™ work (any work on which the phrase “Project Gutenberg” appears, or with which the phrase “Project Gutenberg” is associated) is accessed, displayed, performed, viewed, copied or distributed:

This eBook is for the use of anyone anywhere in the United States and most other parts of the world at no cost and with almost no restrictions whatsoever. You may copy it, give it away or re-use it under the terms of the Project Gutenberg License included with this eBook or online at <https://www.gutenberg.org> . If you are not located in the United States, you'll have to check the laws of the country where you are located before using this ebook.

1.E.2. If an individual Project Gutenberg™ electronic work is derived from texts not protected by U.S. copyright law (does not contain a notice indicating that it is posted with permission of the copyright holder), the work can be copied and distributed to anyone in the United States without paying any fees or charges. If you are redistributing or providing access to a work with the phrase “Project Gutenberg” associated with or appearing on the work, you must comply either with the requirements of paragraphs 1.E.1 through 1.E.7 or obtain permission for the use of the work and the Project Gutenberg™ trademark as set forth in paragraphs 1.E.8 or 1.E.9.

1.E.3. If an individual Project Gutenberg™ electronic work is posted with the permission of the copyright holder, your use and distribution must comply with both paragraphs 1.E.1 through 1.E.7 and any additional terms imposed by the copyright holder. Additional terms will be linked to the Project Gutenberg™ License for all works posted with the permission of the copyright holder found at the beginning of this work.

1.E.4. Do not unlink or detach or remove the full Project Gutenberg™ License terms from this work, or any files containing a part of this work or any other work associated with Project Gutenberg™.

1.E.5. Do not copy, display, perform, distribute or redistribute this electronic work, or any part of this electronic work, without prominently displaying the sentence set forth in paragraph 1.E.1 with active links or immediate access to the full terms of the Project Gutenberg™ License.

1.E.6. You may convert to and distribute this work in any binary, compressed, marked up, nonproprietary or proprietary form, including any word processing or hypertext form. However, if you provide access to or distribute copies of a Project Gutenberg™ work in a format other than “Plain Vanilla ASCII” or other format used in the official version posted on the official Project Guten-

berg™ web site (<https://www.gutenberg.org>), you must, at no additional cost, fee or expense to the user, provide a copy, a means of exporting a copy, or a means of obtaining a copy upon request, of the work in its original “Plain Vanilla ASCII” or other form. Any alternate format must include the full Project Gutenberg™ License as specified in paragraph 1.E.1.

1.E.7. Do not charge a fee for access to, viewing, displaying, performing, copying or distributing any Project Gutenberg™ works unless you comply with paragraph 1.E.8 or 1.E.9.

1.E.8. You may charge a reasonable fee for copies of or providing access to or distributing Project Gutenberg™ electronic works provided that

- You pay a royalty fee of 20% of the gross profits you derive from the use of Project Gutenberg™ works calculated using the method you already use to calculate your applicable taxes. The fee is owed to the owner of the Project Gutenberg™ trademark, but he has agreed to donate royalties under this paragraph to the Project Gutenberg Literary Archive Foundation. Royalty payments must be paid within 60 days following each date on which you prepare (or are legally required to prepare) your periodic tax returns. Royalty payments should be clearly marked as such and sent to the Project Gutenberg Literary Archive Foundation at the address specified in Section 4, “Information about donations to the Project Gutenberg Literary Archive Foundation.”
- You provide a full refund of any money paid by a user who notifies you in writing (or by e-mail) within 30 days of receipt that s/he does not agree to the terms of the full Project Gutenberg™ License. You must require such a user to return or destroy all copies of the works possessed in a physical medium and discontinue all use of and all access to other copies of Project Gutenberg™ works.
- You provide, in accordance with paragraph 1.F.3, a full refund of any money paid for a work or a replacement copy, if a defect in the electronic work is discovered and reported to you within 90 days of receipt of the work.
- You comply with all other terms of this agreement for free distribution of Project Gutenberg™ works.

1.E.9. If you wish to charge a fee or distribute a Project Gutenberg™ electronic work or group of works on different terms than are set forth in this agreement, you must obtain permission in writing from both the Project Gutenberg Literary Archive Foundation and The Project Gutenberg Trademark LLC, the owner of the

Project Gutenberg™ trademark. Contact the Foundation as set forth in Section 3. below.

1.F.

1.F.1. Project Gutenberg volunteers and employees expend considerable effort to identify, do copyright research on, transcribe and proofread works not protected by U.S. copyright law in creating the Project Gutenberg™ collection. Despite these efforts, Project Gutenberg™ electronic works, and the medium on which they may be stored, may contain “Defects,” such as, but not limited to, incomplete, inaccurate or corrupt data, transcription errors, a copyright or other intellectual property infringement, a defective or damaged disk or other medium, a computer virus, or computer codes that damage or cannot be read by your equipment.

1.F.2. LIMITED WARRANTY, DISCLAIMER OF DAMAGES – Except for the “Right of Replacement or Refund” described in paragraph 1.F.3, the Project Gutenberg Literary Archive Foundation, the owner of the Project Gutenberg™ trademark, and any other party distributing a Project Gutenberg™ electronic work under this agreement, disclaim all liability to you for damages, costs and expenses, including legal fees. YOU AGREE THAT YOU HAVE NO REMEDIES FOR NEGLIGENCE, STRICT LIABILITY, BREACH OF WARRANTY OR BREACH OF CONTRACT EXCEPT THOSE PROVIDED IN PARAGRAPH 1.F.3. YOU AGREE THAT THE FOUNDATION, THE TRADEMARK OWNER, AND ANY DISTRIBUTOR UNDER THIS AGREEMENT WILL NOT BE LIABLE TO YOU FOR ACTUAL, DIRECT, INDIRECT, CONSEQUENTIAL, PUNITIVE OR INCIDENTAL DAMAGES EVEN IF YOU GIVE NOTICE OF THE POSSIBILITY OF SUCH DAMAGE.

1.F.3. LIMITED RIGHT OF REPLACEMENT OR REFUND – If you discover a defect in this electronic work within 90 days of receiving it, you can receive a refund of the money (if any) you paid for it by sending a written explanation to the person you received the work from. If you received the work on a physical medium, you must return the medium with your written explanation. The person or entity that provided you with the defective work may elect to provide a replacement copy in lieu of a refund. If you received the work electronically, the person or entity providing it to you may choose to give you a second opportunity to receive the work electronically in lieu of a refund. If the second copy is also defective, you may demand a refund in writing without further opportunities to fix the problem.

1.F.4. Except for the limited right of replacement or refund set forth in paragraph 1.F.3, this work is provided to you ‘AS-IS,’ WITH NO OTHER WARRANTIES OF ANY KIND, EXPRESS OR IMPLIED, INCLUDING BUT NOT LIMITED TO WARRANTIES OF MERCHANTABILITY OR FITNESS FOR ANY PUR-

POSE.

1.F.5. Some states do not allow disclaimers of certain implied warranties or the exclusion or limitation of certain types of damages. If any disclaimer or limitation set forth in this agreement violates the law of the state applicable to this agreement, the agreement shall be interpreted to make the maximum disclaimer or limitation permitted by the applicable state law. The invalidity or unenforceability of any provision of this agreement shall not void the remaining provisions.

1.F.6. INDEMNITY – You agree to indemnify and hold the Foundation, the trademark owner, any agent or employee of the Foundation, anyone providing copies of Project Gutenberg™ electronic works in accordance with this agreement, and any volunteers associated with the production, promotion and distribution of Project Gutenberg™ electronic works, harmless from all liability, costs and expenses, including legal fees, that arise directly or indirectly from any of the following which you do or cause to occur: (a) distribution of this or any Project Gutenberg™ work, (b) alteration, modification, or additions or deletions to any Project Gutenberg™ work, and (c) any Defect you cause.

Section 2. Information about the Mission of Project Gutenberg™

Project Gutenberg™ is synonymous with the free distribution of electronic works in formats readable by the widest variety of computers including obsolete, old, middle-aged and new computers. It exists because of the efforts of hundreds of volunteers and donations from people in all walks of life.

Volunteers and financial support to provide volunteers with the assistance they need, is critical to reaching Project Gutenberg™'s goals and ensuring that the Project Gutenberg™ collection will remain freely available for generations to come. In 2001, the Project Gutenberg Literary Archive Foundation was created to provide a secure and permanent future for Project Gutenberg™ and future generations. To learn more about the Project Gutenberg Literary Archive Foundation and how your efforts and donations can help, see Sections 3 and 4 and the Foundation web page at <https://www.pgla.org> .

Section 3. Information about the Project Gutenberg Literary Archive Foundation

The Project Gutenberg Literary Archive Foundation is a non profit 501(c)(3) educational corporation organized under the laws of the state of Mississippi and

granted tax exempt status by the Internal Revenue Service. The Foundation's EIN or federal tax identification number is 64-6221541. Contributions to the Project Gutenberg Literary Archive Foundation are tax deductible to the full extent permitted by U.S. federal laws and your state's laws.

The Foundation's principal office is in Fairbanks, Alaska, with the mailing address: PO Box 750175, Fairbanks, AK 99775, but its volunteers and employees are scattered throughout numerous locations. Its business office is located at 809 North 1500 West, Salt Lake City, UT 84116, (801) 596-1887, email business@pglaf.org. Email contact links and up to date contact information can be found at the Foundation's web site and official page at www.gutenberg.org/contact

For additional contact information:

Dr. Gregory B. Newby
Chief Executive and Director
gbnewby@pglaf.org

Section 4. Information about Donations to the Project Gutenberg Literary Archive Foundation

Project Gutenberg™ depends upon and cannot survive without wide spread public support and donations to carry out its mission of increasing the number of public domain and licensed works that can be freely distributed in machine readable form accessible by the widest array of equipment including outdated equipment. Many small donations (\$1 to \$5,000) are particularly important to maintaining tax exempt status with the IRS.

The Foundation is committed to complying with the laws regulating charities and charitable donations in all 50 states of the United States. Compliance requirements are not uniform and it takes a considerable effort, much paperwork and many fees to meet and keep up with these requirements. We do not solicit donations in locations where we have not received written confirmation of compliance. To SEND DONATIONS or determine the status of compliance for any particular state visit <https://www.gutenberg.org/donate>

While we cannot and do not solicit contributions from states where we have not met the solicitation requirements, we know of no prohibition against accepting unsolicited donations from donors in such states who approach us with offers to donate.

International donations are gratefully accepted, but we cannot make any

statements concerning tax treatment of donations received from outside the United States. U.S. laws alone swamp our small staff.

Please check the Project Gutenberg Web pages for current donation methods and addresses. Donations are accepted in a number of other ways including checks, online payments and credit card donations. To donate, please visit: <https://www.gutenberg.org/donate>

Section 5. General Information About Project Gutenberg™ electronic works.

Professor Michael S. Hart was the originator of the Project Gutenberg™ concept of a library of electronic works that could be freely shared with anyone. For thirty years, he produced and distributed Project Gutenberg™ eBooks with only a loose network of volunteer support.

Project Gutenberg™ eBooks are often created from several printed editions, all of which are confirmed as not protected by copyright in the U.S. unless a copyright notice is included. Thus, we do not necessarily keep eBooks in compliance with any particular paper edition.

Most people start at our Web site which has the main PG search facility:

<https://www.gutenberg.org>

This Web site includes information about Project Gutenberg™, including how to make donations to the Project Gutenberg Literary Archive Foundation, how to help produce our new eBooks, and how to subscribe to our email newsletter to hear about new eBooks.